



spanish english

la paella
paella

la lima
lime

el arroz
rice

el mejillón
mussel



BILINGUAL DICTIONARY

Feralan.com

VISUAL



Bilingual **VISUAL** dictionary

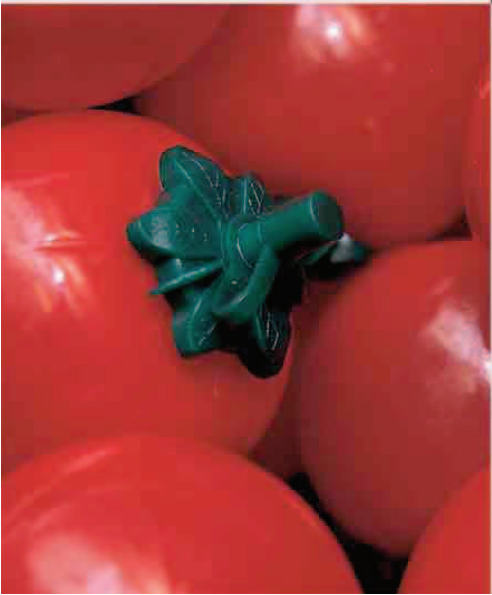

Bilingual VISUAL dictionary

Previously published as part of
5-Language Visual Dictionary



Feralan.com



Penguin
Random
House

Senior Editor Angeles Gavira

Senior Art Editor Ina Stradins

DTP Designers Sunil Sharma, Balwant Singh,
Harish Aggarwal, John Goldsmid, Ashwani Tyagi

DTP Coordinator Pankaj Sharma

Production Controller Liz Cherry

Picture Researcher Anna Grapes

Managing Editor Liz Wheeler

Managing Art Editor Phil Ormerod

Category Publisher Jonathan Metcalf

Designed for Dorling Kindersley by WaltonCreative.com

Art Editor Colin Walton, assisted by Tracy Musson

Designers Peter Radcliffe, Earl Neish, Ann Cannings

Picture Research Marissa Keating

Language content for Dorling Kindersley by
g-and-w PUBLISHING

Managed by Jane Wightwick, assisted by Ana Bremón

Translation and editing by Christine Arthur

Additional input by Dr. Arturo Pretel, Martin Prill,

Frédéric Monteil, Meinrad Prill, Mari Bremón,

Oscar Bremón, Anunchi Bremón, Leila Gaafar

First American Edition, 2009

This edition published in the United States in 2015

by DK Publishing, 345 Hudson Street, New York,
New York 10014

Copyright © 2015 Dorling Kindersley Limited

A Penguin Random House Company

15 16 17 18 19 10 9 8 7 6 5 4 3 2 1

001 – BD219 – June/15

All rights reserved.

Without limiting the rights under the copyright reserved
above, no part of this publication may be reproduced,
stored in or introduced into a retrieval system, or transmitted,
in any form, or by any means (electronic, mechanical,
photocopying, recording, or otherwise), without the prior
written permission of the copyright owner.

Published in Great Britain by Dorling Kindersley Limited.

A catalog record for this book is available from the
Library of Congress.

ISBN: 978-1-4654-3699-3

DK books are available at special discounts when purchased
in bulk for sales promotions, premiums, fund-raising, or
educational use. For details, contact: DK Publishing Special
Markets, 345 Hudson Street, New York, New York 10014
SpecialSales@dk.com

Printed and bound in China

All images © Dorling Kindersley Limited

For further information see: www.dkimages.com

A WORLD OF IDEAS:
SEE ALL THERE IS TO KNOW

www.dk.com

contenido contents

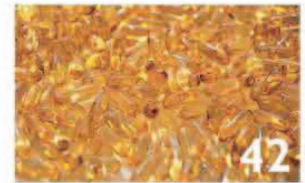

la salud
health



comer fuera
eating out



el ocio
leisure



8

sobre el diccionario
about the dictionary



9

cómo utilizar este libro
how to use this book



10

la gente
people



28

el aspecto
appearance



56

la casa
home



92

los servicios
services



102

las compras
shopping



116

los alimentos
food



160

el estudio
study



170

el trabajo
work



192

el transporte
transportation



218

los deportes
sports



278

el medio ambiente
environment



302

los datos
reference



324

índice
index



360

agradecimientos
acknowledgments

la gente • people

el cuerpo | body 12
la cara | face 14
la mano | hand 15
el pie | foot 15
los músculos | muscles 16
el esqueleto | skeleton 17
los órganos internos 18
 internal organs
los órganos reproductores 20
 reproductive organs
la familia | family 22
las relaciones 24
 relationships
las emociones | emotions 25
los acontecimientos 26
de una vida | life events

el aspecto • appearance

la ropa de niño 30
 children's clothing
la ropa de caballero 32
 men's clothing
la ropa de dama (C**la ropa de** 34
señora) | women's clothing
los accesorios | accessories 36
el pelo | hair 38
la belleza | beauty 40

la salud • health

la enfermedad | illness 44
el médico | doctor 45
la lesión | injury 46
los primeros auxilios 47
 first aid
el hospital | hospital 48
el dentista | dentist 50
el óptico | optometrist 51
el embarazo | pregnancy 52
el parto | childbirth 53

las terapias alternativas 54
 complementary therapy

la casa • home

la casa | house 58
las instalaciones internas 60
 internal systems
la sala (C**el cuarto de estar**) 62
 living room
el comedor | dining room 64
la cocina | kitchen 66
los utensilios de cocina 68
 kitchenware
el dormitorio | bedroom 70
el cuarto de baño 72
 bathroom
la habitación de los niños 74
 baby's room
la lavandería (C**el lavadero**) 76
 utility room
el taller | workshop 78
la caja de las herramientas 80
 toolbox
la decoración | decorating 82
el jardín | garden 84
las plantas de jardín 86
 garden plants
las herramientas de 88
jardinería | garden tools
la jardinería | gardening 90
los servicios •
services
los servicios de emergencia 94
 emergency services
el banco | bank 96

las comunicaciones 98
 communications
el hotel | hotel 100

las compras • shopping

el centro comercial 104
 shopping center
las tiendas departamentales 105
 (C**los grandes almacenes**)
 department store
el supermercado 106
 supermarket
la farmacia | pharmacy 108
la florería (C**la floristería**) 110
 florist
los tabacos y las revistas 112
 (C**el vendedor de periódicos**)
 newsstand
la dulcería (C**el vendedor de** 113
golosinas) | confectionery
las otras tiendas 114
 other stores
los alimentos • food
la carne | meat 118
el pescado | fish 120
las verduras | vegetables 122
la fruta | fruit 126
los granos y las 130
legumbres | grains and legumes
las hierbas y las especias 132
 herbs and spices
los alimentos embotellados 134
 bottled foods
los productos lácteos 136
 dairy produce
el pan y las harinas 138
 breads and flours
la repostería 140
 cakes and desserts
la charcutería | delicatessen 142
las bebidas | drinks 144

comer fuera •
eating out
 la cafetería | café 148
 el bar | bar 150
 el restaurante | restaurant 152
 la comida rápida | fast food 154
 el desayuno | breakfast 156
 la comida principal 158
 dinner

el estudio • study
 la escuela (el colegio) 162
 school
 las matemáticas | math 164
 las ciencias | science 166
 la enseñanza superior 168
 college

el trabajo • work
 la oficina | office 172
 la computadora 176
 (el ordenador) computer
 los medios de 178
 comunicación | media
 el derecho | law 180
 la granja | farm 182
 la construcción | construction 186
 las profesiones | professions 188

el transporte •
transportation
 las carreteras | roads 194
 el autobús | bus 196
 el carro (el coche) | car 198
 la motocicleta | motorcycle 204
 la bicicleta | bicycle 206
 el tren | train 208
 el avión | aircraft 210
 el aeropuerto | airport 212
 el barco | ship 214

el puerto | port 216

los deportes • sport
 el fútbol americano 220
 football
 el rugby | rugby 221
 el fútbol | soccer 222
 el hockey | hockey 224
 el críquet | cricket 225
 el baloncesto | basketball 226
 el béisbol | baseball 228
 el tenis | tennis 230
 el golf | golf 232
 el atletismo | track and field 234
 los deportes de combate 236
 combat sports
 la natación | swimming 238
 la vela | sailing 240
 la equitación | horse riding 242
 la pesca | fishing 244
 el esquí | skiing 246
 los otros deportes 248
 other sports
 la forma física | fitness 250

el ocio • leisure
 el teatro | theater 254
 la orquesta | orchestra 256
 el concierto | concert 258
 el turismo | sightseeing 260
 las actividades al aire libre 262
 outdoor activities
 la playa | beach 264
 el camping | camping 266
 el ocio en el hogar 268
 home entertainment
 la fotografía | photography 270
 los juegos | games 272
 las manualidades 274
 arts and crafts



el medio ambiente
 • environment
 el espacio | space 280
 la Tierra | Earth 282
 el paisaje | landscape 284
 el tiempo | weather 286
 las rocas | rocks 288
 los minerales | minerals 289
 los animales | animals 290
 las plantas | plants 296
 la ciudad | town 298
 la arquitectura 300
 architecture

los datos • reference
 el tiempo | time 304
 el calendario 306
 (el almanaque) | calendar
 los números | numbers 308
 los pesos y las medidas 310
 weights and measures
 el mapamundi 312
 world map
 partículas y antónimos 320
 particles and antonyms
 frases útiles | useful phrases 322

sobre el diccionario

Está comprobado que el empleo de fotografías ayuda a la comprensión y a la retención de información. Basados en este principio, este diccionario bilingüe y altamente ilustrado exhibe un amplio registro de vocabulario útil y actual en dos idiomas europeos.

El diccionario aparece dividido según su temática y abarca la mayoría de los aspectos del mundo cotidiano con detalle, desde el restaurante al gimnasio, la casa al lugar de trabajo, el espacio al reino animal. Encontrará también palabras y frases adicionales para su uso en conversación y para ampliar su vocabulario.

Este diccionario es un instrumento de referencia esencial para todo aquél que esté interesado en los idiomas; es práctico, estimulante y fácil de usar.

Algunos puntos a observar

Los dos idiomas se presentan siempre en el mismo orden: español (mejicano y castellano) e inglés. Cuando existen diferencias entre el castellano y el español mejicano, el mejicano aparece primero seguido por el castellano; este último entre paréntesis e indicado con una ^C: **la llave** (^C**el grifo**).

En español, los sustantivos se muestran con sus artículos definidos reflejando el género (masculino o femenino) y el número (singular/plural):

la semilla seed	las almendras almonds
---------------------------	---------------------------------

Los verbos se indican con una (v) después del inglés:

recolectar • harvest (v)

Cada idioma tiene su propio índice. Aquí podrá mirar una palabra en cualquiera de los dos idiomas y se le indicará el número de la página donde aparece. El género se indica utilizando las siguientes abreviaturas:

m = masculino f = femenino

about the dictionary

The use of pictures is proven to aid understanding and the retention of information. Working on this principle, this highly illustrated bilingual dictionary presents a large range of useful current vocabulary in two European languages.

The dictionary is divided thematically and covers most aspects of the everyday world in detail, from the restaurant to the gym, the home to the workplace, outer space to the animal kingdom. You will also find additional words and phrases for conversational use and for extending your vocabulary.

This is an essential reference tool for anyone interested in languages—practical, stimulating, and easy-to-use.

A few things to note

The two languages are always presented in the same order—Spanish (Mexican and Castilian) and English. Where a word or phrase is different in Castilian and Mexican Spanish, the Mexican appears first, followed by the Castilian; the latter in brackets and indicated by a ^C: **la llave** (^C**el grifo**).

In Spanish, nouns are given with their definite articles reflecting the gender (masculine or feminine) and number (singular or plural), for example:

la semilla seed	las almendras almonds
---------------------------	---------------------------------

Verbs are indicated by a (v) after the English, for example:

recolectar • harvest (v)

Each language also has its own index at the back of the book. Here you can look up a word in either of the two languages and be referred to the page number(s) where it appears. The gender is shown using the following abbreviations:

m = masculine f = feminine



cómo utilizar este libro

Ya se encuentre aprendiendo un idioma nuevo por motivos de trabajo, placer, o para preparar sus vacaciones al extranjero, o ya quiera ampliar su vocabulario en un idioma que ya conoce, este diccionario es un instrumento muy valioso que podrá utilizar de distintas maneras.

Cuando esté aprendiendo un idioma nuevo, busque palabras similares en distintos idiomas y palabras que parecen similares pero que poseen significados totalmente distintos. También podrá observar cómo los idiomas se influyen unos a otros. Por ejemplo, la lengua inglesa ha importado muchos términos de comida de otras lenguas pero, a cambio, ha exportado términos empleados en tecnología y cultura popular.

Actividades prácticas de aprendizaje

- Mientras se desplaza por su casa, lugar de trabajo o colegio, intente mirar las páginas que se refieren a ese lugar. Podrá entonces cerrar el libro, mirar a su alrededor y ver cuántos objetos o características puede nombrar.
- Desafíese a usted mismo a escribir una historia, carta o diálogo empleando tantos términos de una página concreta como le sea posible. Esto le ayudará a retener vocabulario y recordar la ortografía. Si quiere ir progresando para poder escribir un texto más largo, comience con frases que incorporen 2 ó 3 palabras.
- Si tiene buena memoria visual, intente dibujar o calcar objetos del libro; luego cierre el libro y escriba las palabras correspondientes debajo del dibujo.
- Cuando se sienta más seguro, escoja palabras del índice de uno de los idiomas y vea si sabe lo que significan antes de consultar la página correspondiente para comprobarlo.

how to use this book

Whether you are learning a new language for business, pleasure, or in preparation for an overseas vacation, or are hoping to extend your vocabulary in an already familiar language, this dictionary is a valuable learning tool that you can use in a number of different ways.

When learning a new language, look for cognates (words that are alike in different languages) and "false friends" (words that look alike but carry significantly different meanings). You can also see where the languages have influenced each other. For example, English has imported many terms for food from other European languages but, in turn, exported terms used in technology and popular culture.

Practical learning activities

- As you move around your home, workplace, or school, try looking at the pages which cover that setting. You could then close the book, look around you, and see how many of the objects and features you can name.
- Challenge yourself to write a story, letter, or dialogue using as many of the terms on a particular page as possible. This will help you retain the vocabulary and remember the spelling. If you want to build up to writing a longer text, start with sentences incorporating 2–3 words.
- If you have a very visual memory, try drawing or tracing items from the book onto a piece of paper, then closing the book and filling in the words below the picture.
- Once you are more confident, pick out words in a foreign-language index and see if you know what they mean before turning to the relevant page to see if you were right.







la gente
people

el cuerpo • body

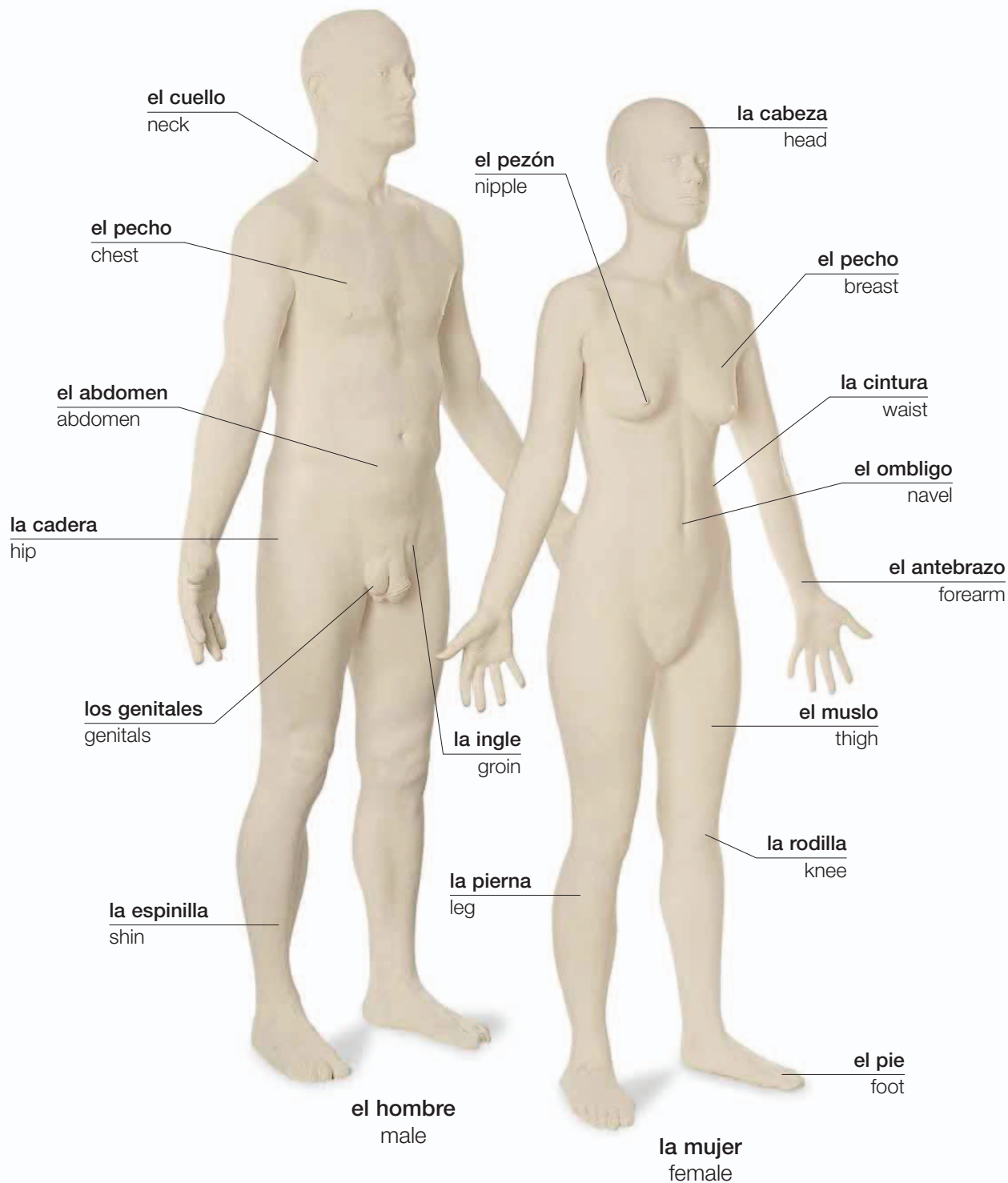

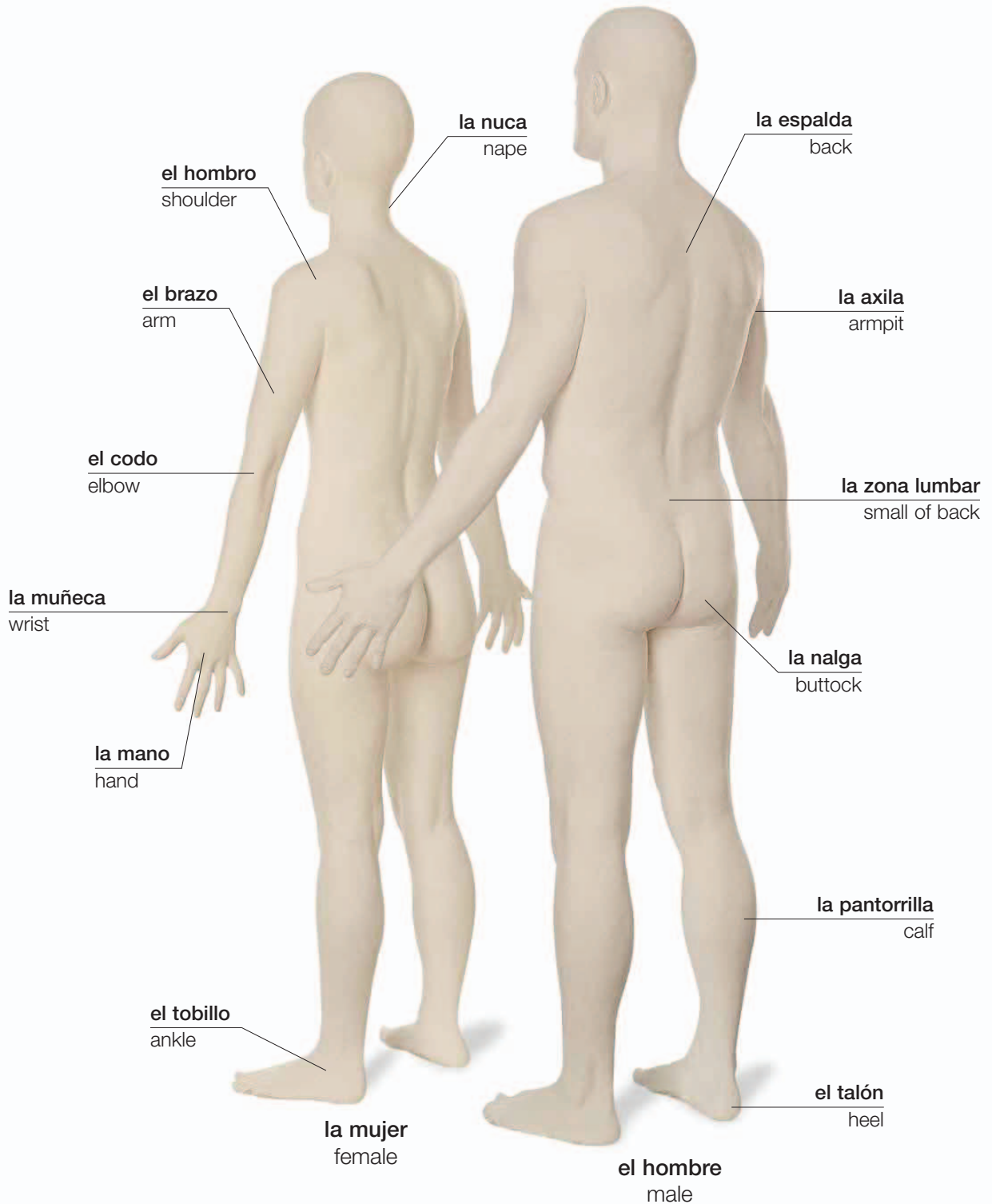

la cara • face

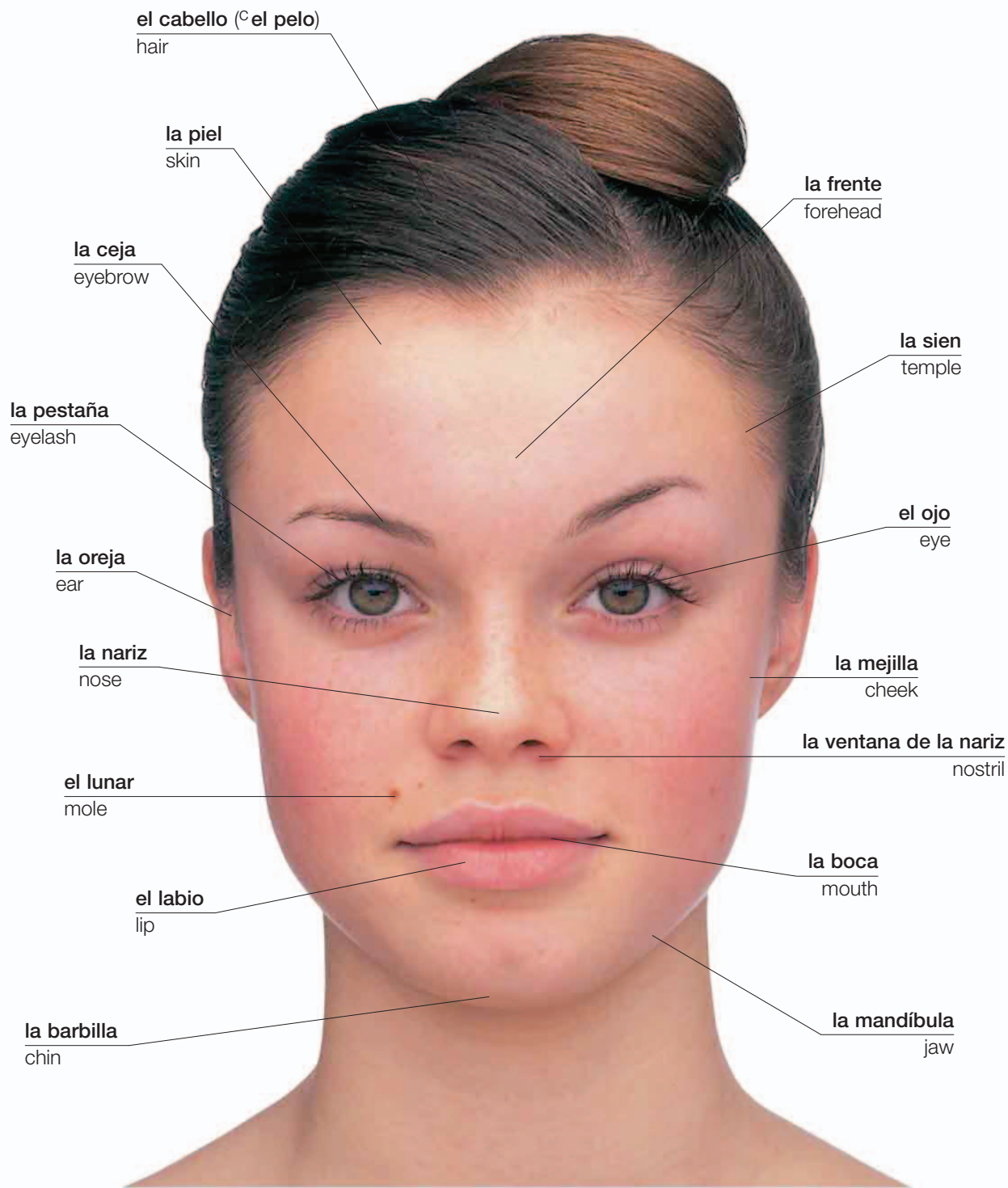



la arruga
wrinkle

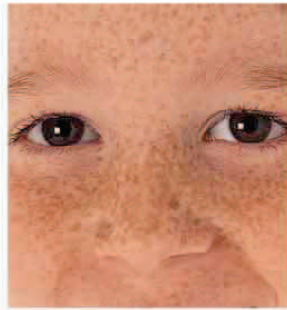

la peca
freckle

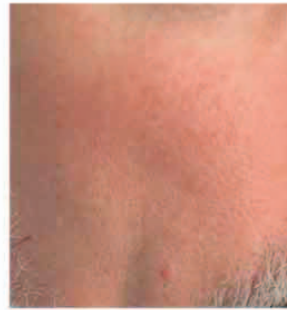

el poro
pore

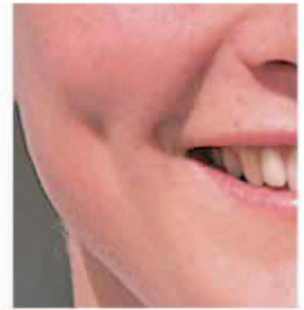

el hoyuelo
dimple

la mano • hand



el pie • foot



los músculos • muscles

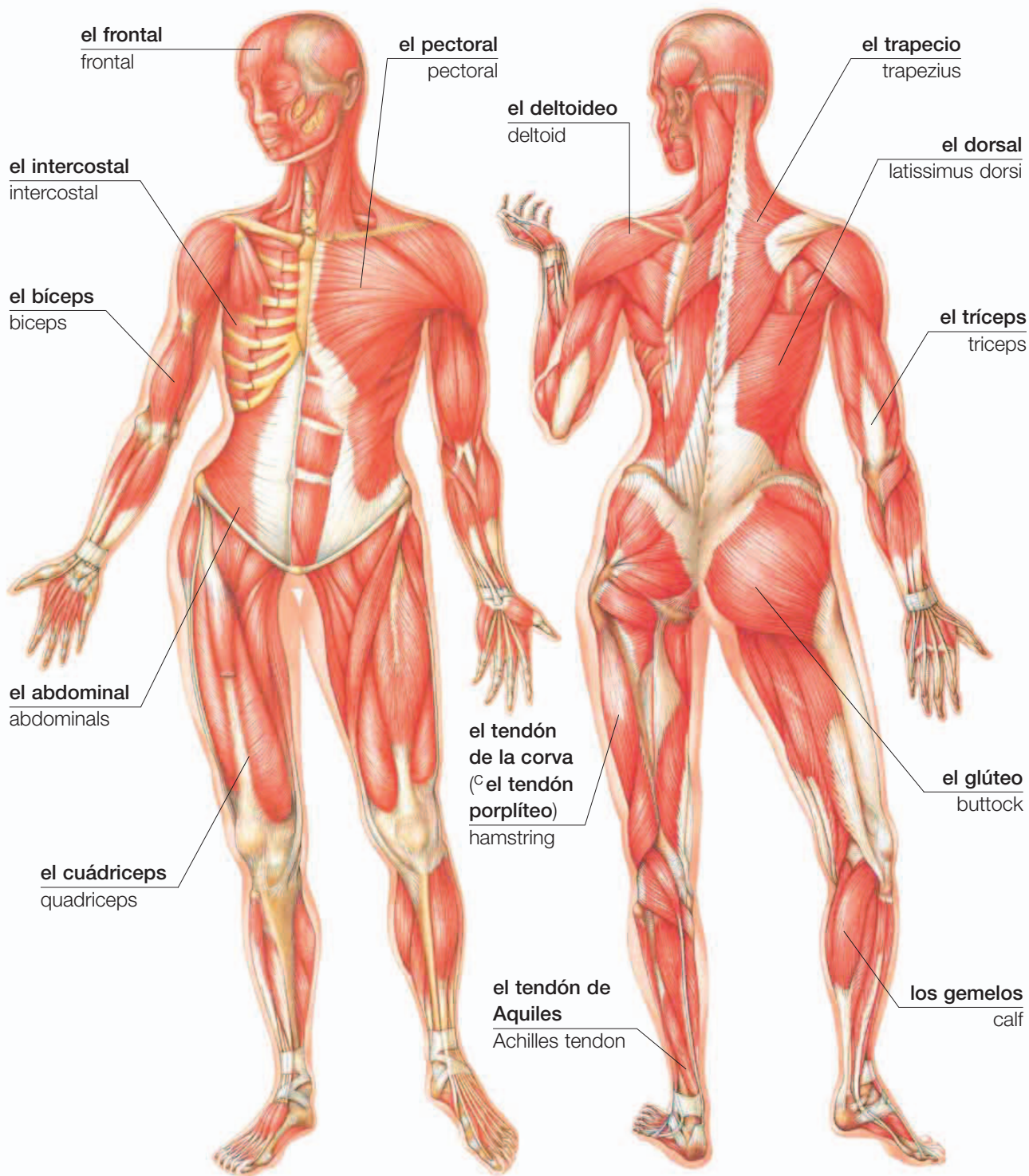

el esqueleto • skeleton

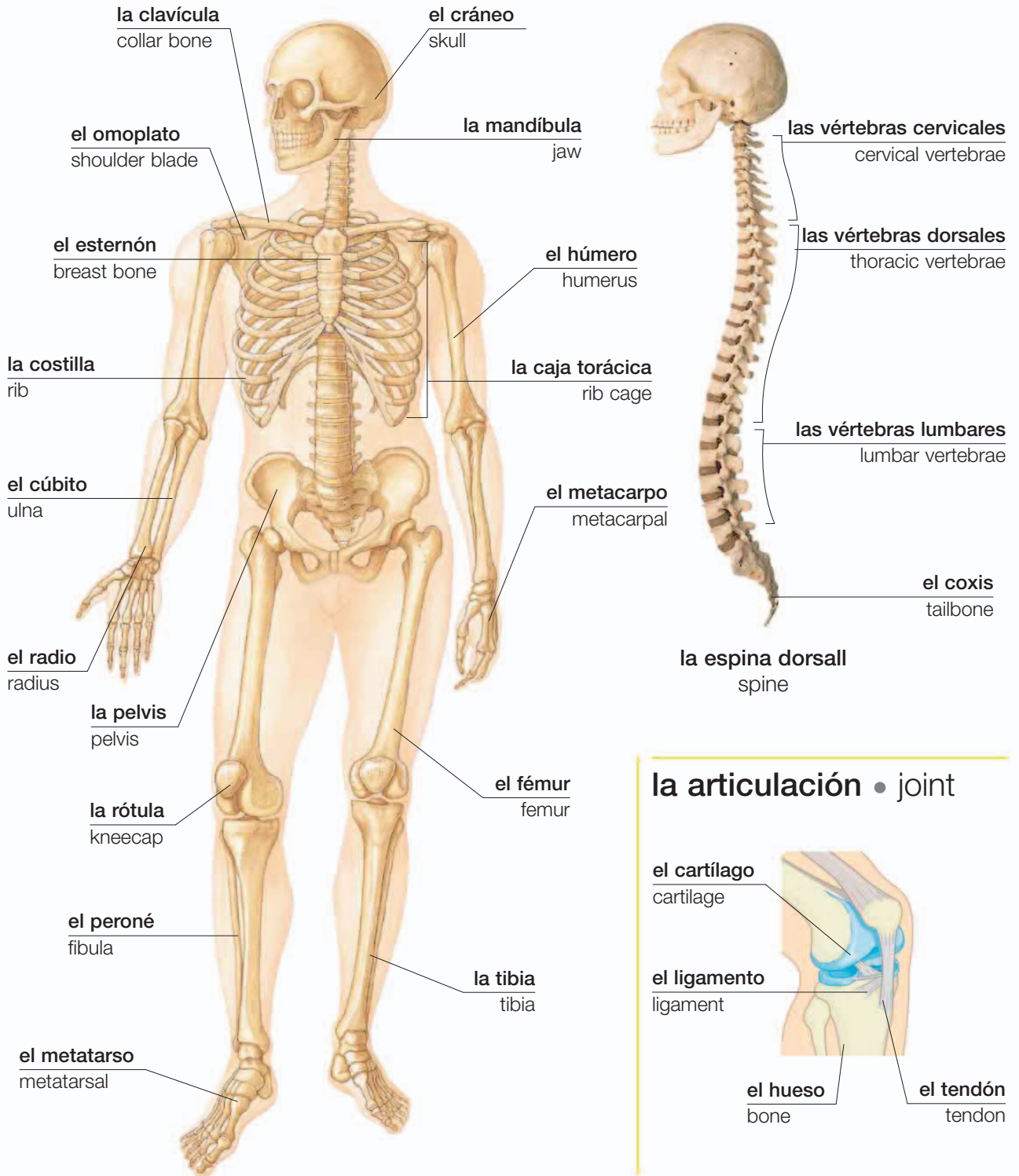

los órganos internos • internal organs

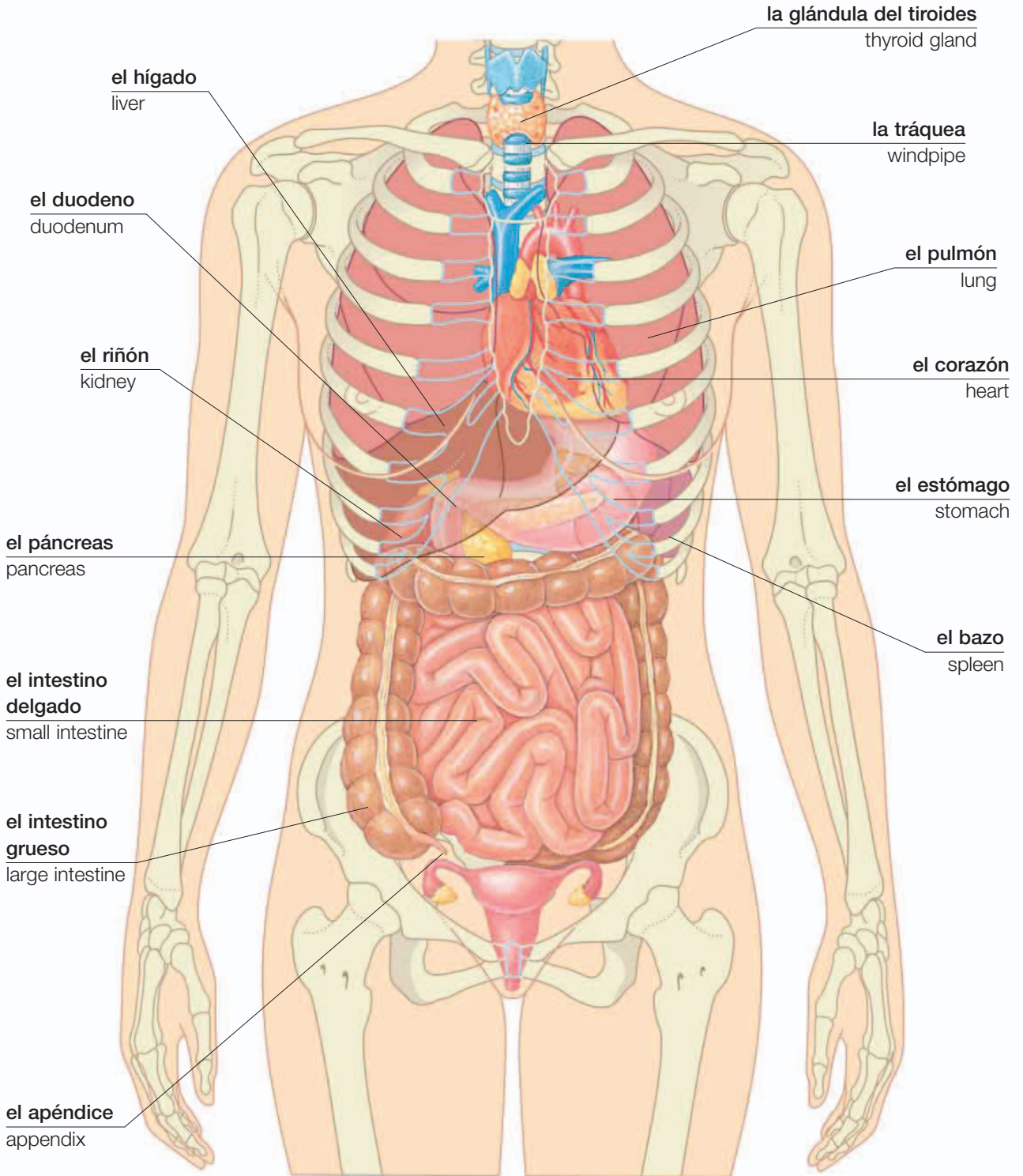

la cabeza • head

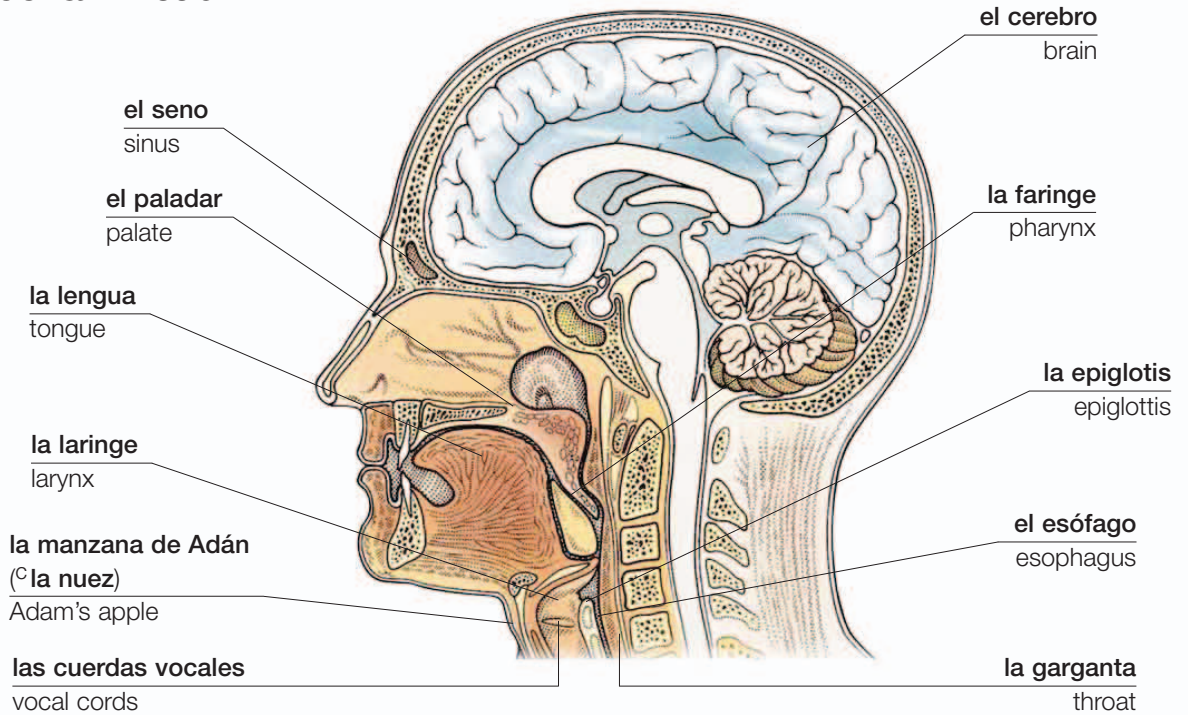

los sistemas • body systems

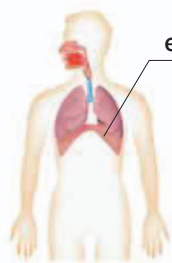

respiratorio
respiratory

el diafragma
diaphragm

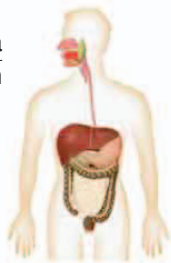

digestivo
digestive

la vena
vein



cardiovascular
cardiovascular

la arteria
artery



linfático
lymphatic

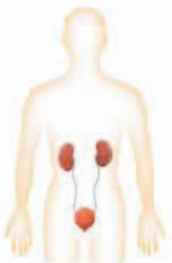

urinario
urinary

la glándula
gland

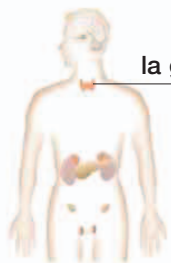

endocrino
endocrine

el nervio
nerve



nervioso
nervous



reproductor
reproductive

los órganos reproductores • reproductive organs

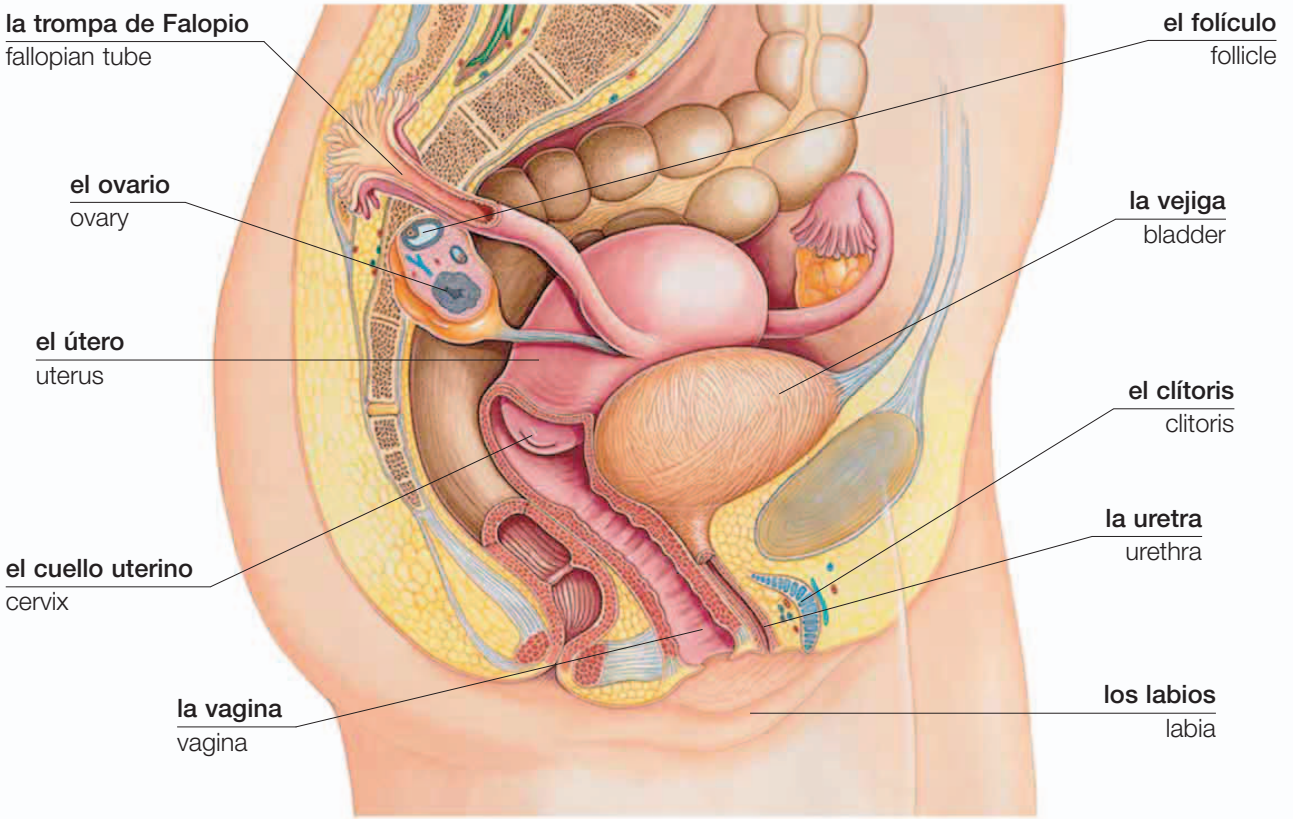

femenino | female

la reproducción • reproduction

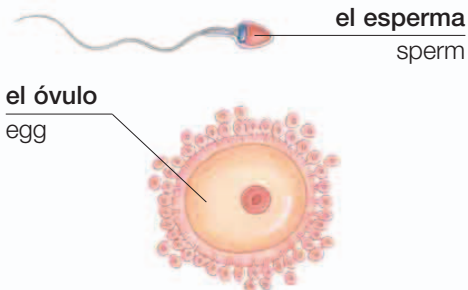

la fertilización | fertilization

vocabulario • vocabulary

la hormona
hormone

impotente
impotent

la menstruación
menstruation

la ovulación
ovulation

fértil
fertile

el coito
intercourse

estéril
infertile

concebir
conceive

la enfermedad de
transmisión sexual
sexually transmitted disease

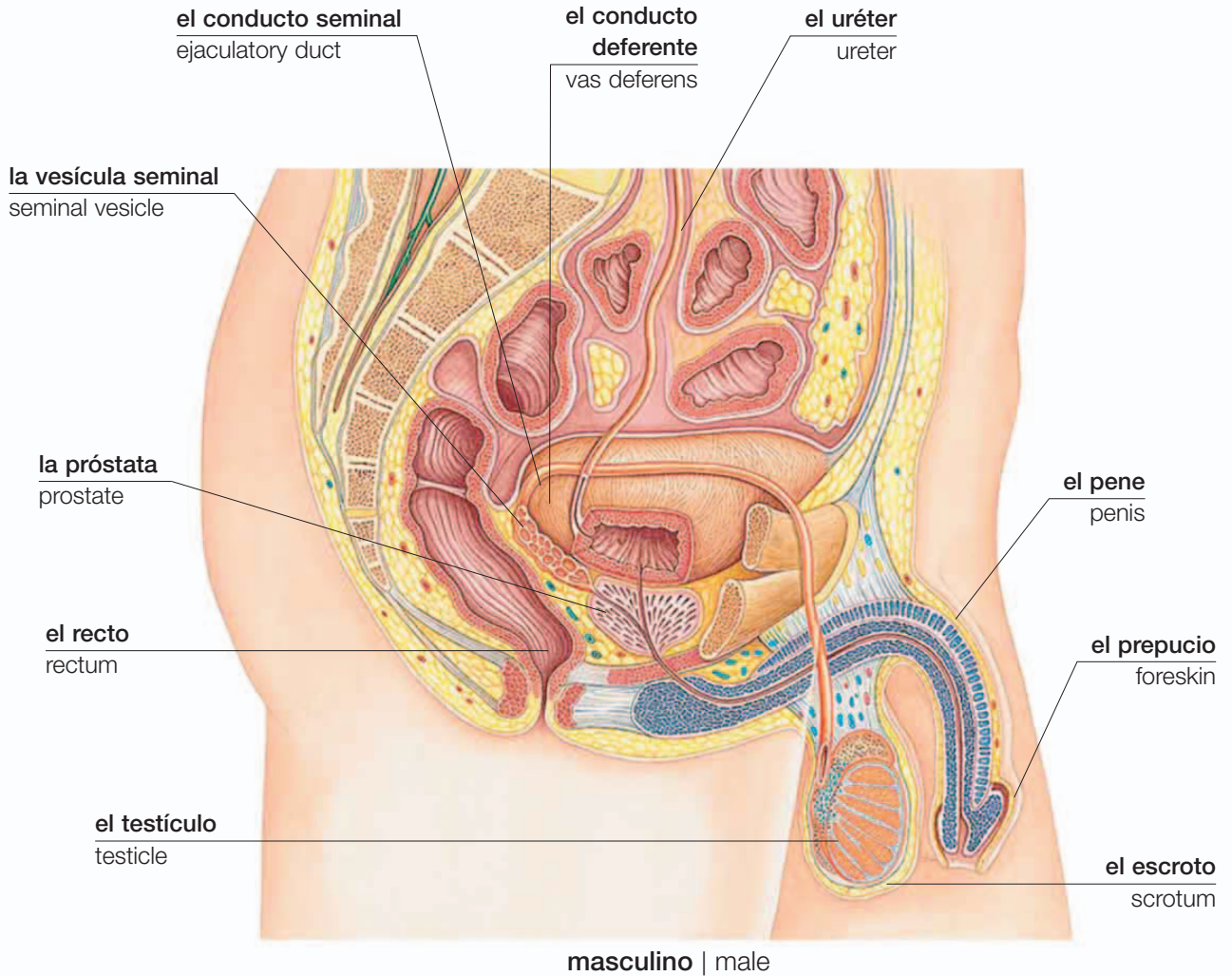

la anticoncepción • contraception



la familia • family

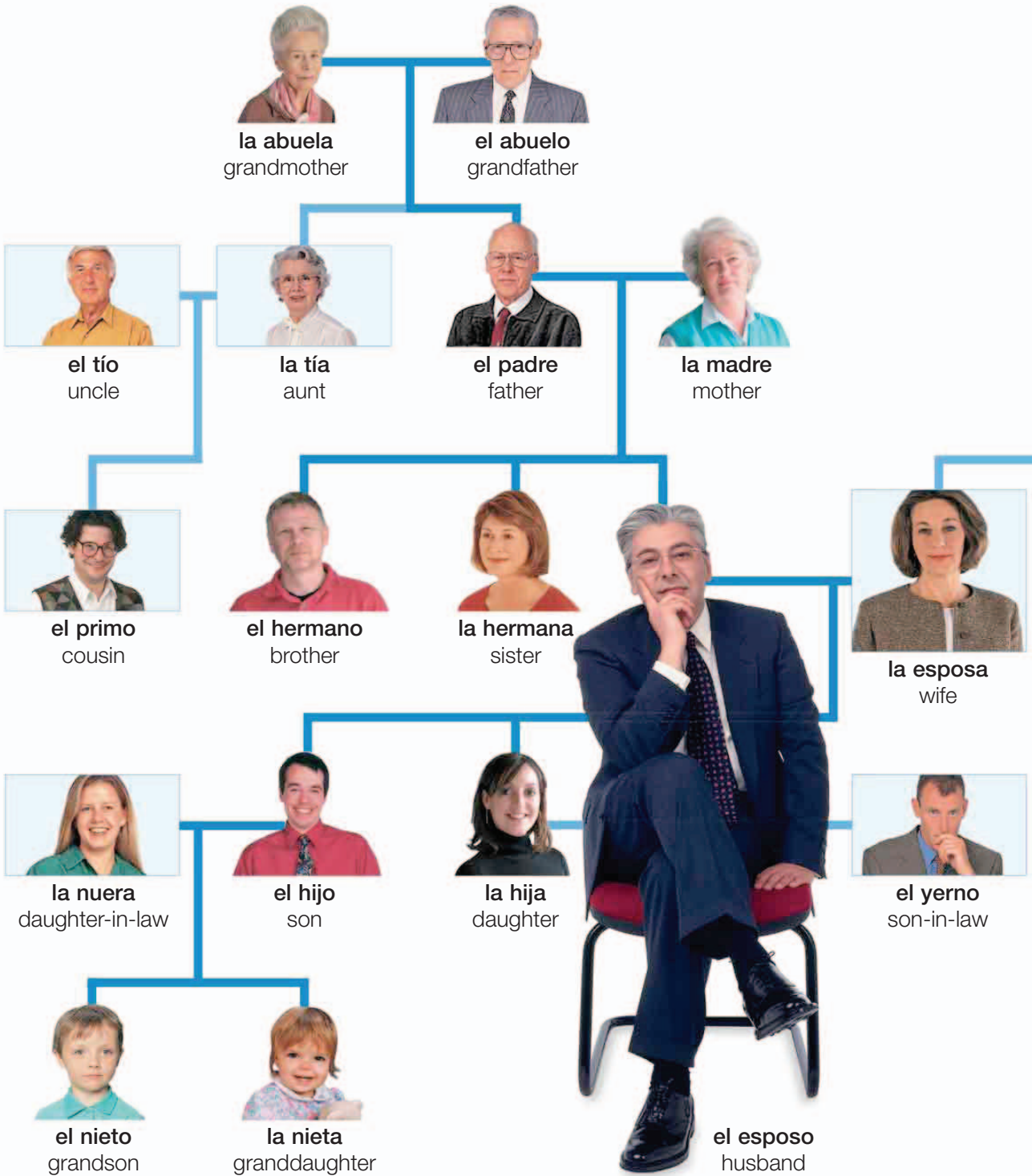

vocabulario • vocabulary

los parientes relatives	los padres parents	los nietos grandchildren	la madrastra stepmother	el hijastro stepson	la generación generation
los abuelos grandparents	los niños children	el padrastro stepfather	la hijastra stepdaughter	el/la compañero/-a partner	los gemelos twins



la suegra
mother-in-law

el suegro
father-in-law



el cuñado
brother-in-law

la cuñada
sister-in-law



la sobrina
niece

el sobrino
nephew

Señorita
Miss

los tratamientos

• titles

Señora
Mrs

Señor
Mr



las etapas • stages



el bebé
baby



el niño
child



el niño
boy



la niña
girl



la adolescente
teenager



el adulto
adult



el hombre
man



la mujer
woman

las relaciones • relationships

la asistente
(^cla ayudante)
assistant

el jefe
manager

la socia
business
partner

el empleado
employee

la empresaria
employer

el compañero
colleague



la oficina | office



el vecino
neighbor



el amigo
friend



el conocido
acquaintance



el amigo por correspondencia
pen pal



el novio
boyfriend

la novia
girlfriend

la pareja | couple



el prometido
fiancé

la prometida
fiancée

la pareja | engaged couple

las emociones • emotions



contento
happy



triste
sad



entusiasmado
excited



aburrido
bored



sorprendido
surprised



asustado
scared



enfadado
angry



confuso
confused



preocupado
worried



nervioso
nervous



orgullosa
proud



seguro de sí mismo
confident



avergonzado
embarrassed



tímido
shy

vocabulario • vocabulary

triste upset	reír laugh (v)	suspirar sigh (v)	gritar shout (v)
------------------------	--------------------------	-----------------------------	----------------------------

horrorizado shocked	llorar cry (v)	desmayarse faint (v)	bostezar yawn (v)
-------------------------------	--------------------------	--------------------------------	-----------------------------

los acontecimientos de una vida • life events



nacer
be born (v)



empezar el colegio
start school (v)



hacer amigos
make friends (v)



graduarse (licenciarse)
graduate (v)

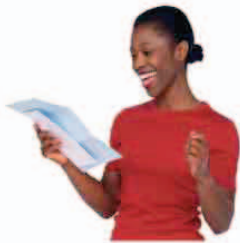

conseguir un trabajo
get a job (v)



enamorarse
fall in love (v)



casarse
get married (v)



tener un hijo
have a baby (v)



la boda | wedding



el divorcio
divorce



el funeral
funeral

vocabulario • vocabulary

el bautizo
christening

morir
die (v)

el bar mitzvah
bar mitzvah

hacer testamento
make a will (v)

el aniversario
anniversary

el banquete de boda
wedding reception

emigrar
emigrate (v)

la luna de miel
honeymoon

retirarse
retire (v)

**el acta (la partida)
de nacimiento**
birth certificate

las celebraciones • celebrations

la fiesta de cumpleaños
birthday party



el cumpleaños
birthday

la tarjeta
card



el regalo
present



la Navidad
Christmas

los festivales • festivals



la Pascua judía
Passover



el Año Nuevo
New Year



el carnaval
carnival

el desfile
procession



el Ramadán
Ramadan

la cinta
ribbon



el día de Acción de Gracias
Thanksgiving



la Pascua (c) la
Semana Santa)
Easter



el día de Halloween
Halloween



el Diwali
Diwali





la apariencia
appearance

la ropa de niño • children's clothing

el bebé • baby



la camiseta
(^cel body)
undershirt

el botón (^cel
corchete)
snap

el mameluco
(^cel pelele con pies)
onesize



el mameluco
(^cel pijama enterizo)
sleeper



el traje de invierno (^cel buzo)
snowsuit



el mameluco (^cel
pelele) sin pies
romper suit



el babero
bib



los guantes
(^clos manoplas)
mittens



las botas
(^clos patucos)
booties



el pañal de felpa
cloth diaper



el pañal
desechable
disposable diaper



el calzón (^clas bra-
guitas) de plástico
plastic underpants

el niño pequeño • toddler



el gorro para el sol
sun bonnet



el delantal
apron



los pantalones
con peto
overalls

los shorts
(^clos pantalones
cortos)
shorts



la playera
(^cla camiseta)
t-shirt



la falda
skirt

el niño • child



el vestido
dress

los jeans
(^c los pantalones
vaqueros)
jeans

la capucha
hood



los huaraches
(^c las sandalias)
sandals

el verano
summer

el impermeable
raincoat



la mochila
backpack

el broche
(^c la muletilla)
toggle



el otoño
fall

el abrigo
(^c la trenca)
duffel coat



la bufanda
scarf

la chamarra
(^c el
chaquetón)
parka

las botas de
agua
galoshes

el invierno
winter



la bata
robe

el logotipo
logo

los tenis
(^c las zapatillas
de deporte)
sneakers

el camisón
nightgown

las pantuflas
slippers

la ropa para dormir
nightwear



el uniforme del
equipo
soccer uniform



los pants
(^c el chándal)
warm-up suit



las mallas
leggings

vocabulario • vocabulary

la fibra natural
natural fiber

sintético
synthetic

¿Se puede lavar en lavadora?
Is it machine washable?

¿Le quedará a un niño de
dos años?
Will this fit a two-year-old?

la ropa de caballero • men's clothing



vocabulario • vocabulary

el cardigan
cardigan

la ropa interior
underwear

la gabardina
([©]el abrigo)
coat

la bata
dressing gown

los pants
tracksuit

corto
short

largo
long

¿Tiene una talla más grande/chica?
Do you have this in a larger/smaller size?

¿Me lo puedo probar?
May I try this on?



el saco (°la chaqueta)
blazer



el saco sport
(°la americana sport)
sport coat



el chaleco
vest

el cuello en V
(°el cuello de pico)
v-neck

el cuello redondo
crew neck

la camiseta
t-shirt



el chaquetón
parka



la sudadera
sweatshirt



la camisa
shirt

los tejanos
jeans



el suéter (°el jersey)
sweater



la pijama (°el pijama)
pajamas



la camiseta de tirantes
undershirt

la ropa casual
(°la ropa casual)
casual wear



los shorts (°los pantalones cortos) | shorts



los calzoncillos
briefs



los boxers (°los calzoncillos de pata) | boxer shorts



los calcetines
socks

la ropa de dama (c de señora) • women's clothing



la lencería • lingerie



la bata
robe



el fondo
(^ola combinación)
slip



el tirante
strap

la camisola
camisole



el corsé con
liguero
bustier

las ligas
garter



la media
stocking



las pantimedias
(^olas medias)
panty hose



el brassiere
(^oel sujetador)
bra



las pantaletas
(^olas bragas)
underpants



el camisón
nightgown

la boda • wedding



el
encaje
lace

el velo
veil

el ramo de flores
bouquet

la cola
train

el vestido de novia
wedding dress

vocabulario • vocabulary

el corsé
corset

la liga
garter belt

el brassiere
(^osujetador)
deportivo
sports bra

entallado
(^osastre)
tailored

la hombrera
shoulder pad

con varillas
(^ocon aros)
underwire

la cinturilla
waistband

con los hombros
al aire
halter neck

los accesorios • accessories



la gorra
cap



el sombrero
hat



la mascada
(^oel pañuelo)
scarf



la hebilla
buckle

el cinturón
belt

el mango
(^oel asa)
handle



la punta
tip

el paraguas
umbrella



el pañuelo
handkerchief



el moño (^ola pajarita)
bow tie



el alfiler de
corbata
tiepin



los guantes
gloves

las joyas • jewelry



el colgije
(^oel colgante)
pendant



el prendedor
(^oel broche)
brooch



las mancuernillas
(^oel gemelo)
cufflink

el collar de perlas
strand of pearls

el eslabón
link



la pulsera
bracelet

el broche
(^oel cierre)
clasp



la cadena
chain

el arete
(^oel pendiente)
earring

el anillo
ring

la piedra
stone

el collar
necklace

el reloj
watch



el joyero | jewelry box

las bolsas • bags



la cartera
wallet



el monedero
change purse



la bolsa (c el bolso)
shoulder bag

el cierre
clasp

la correa
shoulder strap

las asas
handles



la mochila
backpack



la bolsa de viaje
duffle bag



el maletín
briefcase



la bolsa (c el bolso) de mano
handbag

los zapatos • shoes

la agujeta
(c la cordonera)
lace

la lengüeta
tongue

el ojal
eyelet

el tacón
heel

la suela
sole



el zapato de agujetas (c de
cordonerías)
lace-up



la bota
boot



la bota de
trekking
walking boot



el tenis (c la
zapatilla deportiva)
sneaker



la chancla
flip-flop



el zapato de
caballero
brogue



el zapato de
tacón
high heel shoe



la cuña
wedge



la sandalia
sandal



el mocasín
slip-on



la bailarina
pump

el cabello • hair



el peine
comb

peinar
comb (v)



el cepillo
brush

cepillar | brush (v)



enjuagar
rinse (v)



la estilista
(^cla peluquera)
hairdresser

el lavabo
sink

la clienta
client

lavar | wash (v)



la bata
robe

cortar
cut (v)



secar con la secadora
blowdry (v)



marcar
set (v)

los accesorios • accessories



la secadora
(^cel secador)
blow-dryer



el champú
shampoo



el acondicionador (^cel suavizante) | conditioner



el gel
gel



la laca
hairspray



las tenazas
(^clas tenacillas)
curling iron



las tijeras
scissors



la diadema
headband



la plancha de pelo
hair straighteners



el pasador (^cla horquilla) | bobby pin

los estilos • styles



la cola de caballo
ponytail



la trenza
braid



el chongo (°el
moño) francés
French braid



el chongo
(°el moño)
bun



las coletas
pigtails



el príncipe valiente
(°la melena) | bob



el pelo corto
crop



rizado
curly



la permanente
perm



lacio
straight



las raíces
roots

las luces (°los reflejos)
highlights



calvo
bald



la peluca
wig

los colores • colours



güero (°rubio)
blonde



castaño
brunette



rojizo
auburn



pelirrojo
pelirrojo



negro
black



gris
grey



blanco
white



teñido
dyed

vocabulario • vocabulary

la goma del pelo
hair band

graso
greasy

despuntar (°cortar
las puntas)
trim (v)

seco
dry

el peluquero
(°el barbero)
barber

aliciar
(°alisar)
straighten (v)

la caspa
dandruff

normal
normal

la orzuela (°las
puntas abiertas)
split ends

el cuero
cabelludo
scalp

la belleza • beauty



el tinte para el pelo
hair dye

la sombra
de ojos
eye shadow

el rímel
mascara

el delineador
(^c el lápiz de ojos)
eyeliner

el rubor
(^c el colorete)
blusher

la base
(^c el maquillaje de fondo)
foundation

el lápiz labial
lipstick

el maquillaje • makeup



el lápiz de cejas
eyebrow pencil



el cepillo para las cejas
eyebrow brush



las pinzas
tweezers



el brillo de labios
lip gloss



el pincel de labios
lip brush



el lápiz de labios
lip liner



la brocha
brush



el lápiz corrector
concealer

el espejo
mirror

el maquillaje (^c los
polvos compactos)
face powder



la borla
powder puff

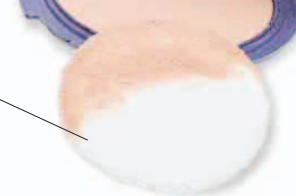

la polvera | compact

los tratamientos de belleza •
beauty treatments

la mascarilla
face pack



la limpieza de cutis
facial



la depilación a la cera
wax



la pedicura
pedicure



la cama de rayos ultravioletas
sunbed



exfoliar
exfoliate (v)

los artículos de tocador •
toiletries



la crema limpiadora
cleanser



el tónico
toner



la crema hidratante
moisturizer



la crema bronceadora
(^cautobronceadora)
self-tanning lotion



el perfume
perfume



el agua de colonia
eau de toilette

la manicura • manicure



la lima de uñas
nail file



el cortaúñas
nail clippers



el quitaesmalte
nail polish remover



el esmalte de uñas
nail polish

vocabulario • vocabulary

el cutis complexion	graso oily	el bronceado tan
claro fair	sensible sensitive	el tatuaje tattoo
moreno dark	hipoalergénico hypoallergenic	antiarrugas antiwrinkle
seco dry	el tono shade	las bolas de algodón cotton balls





la salud
health



Feralan.com

la enfermedad • illness



la fiebre | fever



el dolor de
cabeza
headache



la hemorragia
nasal
nosebleed



la tos
cough



el estornudo
sneeze



el resfriado
cold



la gripe
the flu



el inhalador
inhaler



los calambres
cramps



la náusea
nausea



la varicela
the chickenpox



el sarpullido
rash

el asma
asthma

vocabulario • vocabulary

la apoplejía (°el
derrame cerebral)
stroke

la fiebre del
heno
hay fever

la
infección
infection

el dolor de
estómago
stomach ache

la migraña
(°la jaqueca)
migraine

la diarrea
diarrhea

la diabetes
diabetes

la alergia
allergy

el eccema
eczema

el resfriado
chill

vomitarse
vomit (v)

el sarampión
measles

el ataque cardiaco
(°el infarto de
miocardio)
heart attack

la presión
arterial (°la
tensión arterial)
blood pressure

el virus
virus

desmayarse
faint (v)

la epilepsia
epilepsy

las paperas
mumps

el doctor • doctor
la consulta • consultation

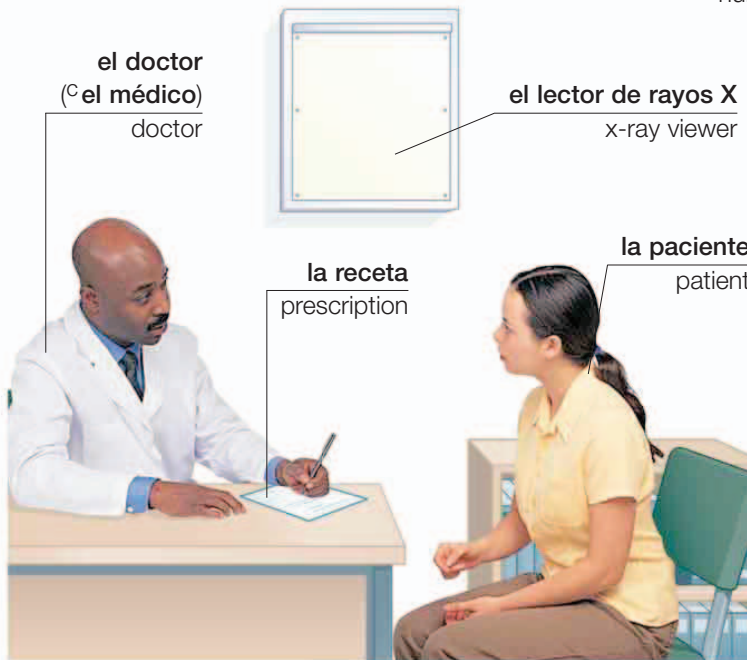

la enfermera
nurse



vocabulario • vocabulary

la cita
appointment

la inoculación
inoculation

la consulta
doctor's office

el termómetro
thermometer

la sala de espera
waiting room

el examen médico
medical examination

Necesito ver a un doctor.
I need to see a doctor.

Me duele aquí.
It hurts here.

la lesión • injury



la torcedura | sprain

el cabestrillo
sling



la fractura
fracture

el collarín
neck brace



el tirón en el cuello
whiplash



la cortada (°el corte)
cut



la raspada (°el arañazo)
graze



el moretón (°el hematoma)
bruise



la astilla
splinter



la ardida (°la quemadura de sol)
sunburn



la quemadura
burn



el mordisco
bite



la picadura
sting

vocabulary • vocabulary

el accidente
accident

la hemorragia
hemorrhage

la conmoción
concussion

¿Se pondrá bien?
Will he/she be all right?

la herida
wound

la ampolla
blister

el envenenamiento
poisoning

Por favor llame a una ambulancia.
Please call an ambulance.

la emergencia
(°la urgencia)
emergency

la lesión en la cabeza
head injury

el shock eléctrico
(°la descarga eléctrica)
electric shock

¿Dónde le duele?
Where does it hurt?

los primeros auxilios • first aid

la pomada
ointment

la tirita
adhesive
bandage

el seguro
(^o el imperdible)
safety pin

la venda
bandage

los analgésicos
painkillers



la toallita
antiséptica
antiseptic wipe

las pinzas
tweezers

las tijeras
scissors

el desinfectante
antiseptic

el botiquín | first aid kit

la gasa
gauze



el vendaje
dressing



la tablilla | splint



la tela adhesiva
(^o el esparadrapo)
adhesive tape



la reanimación
resuscitation

vocabulario • vocabulary

el shock
shock

el pulso
pulse

ahogarse
choke (v)

¿Me puede ayudar?
Can you help?

inconsciente
unconscious

la respiración
breathing

estéril
sterile

¿Sabe primeros
auxilios?
Do you know first aid?

el hospital • hospital



el análisis de sangre
blood test



la inyección
injection



la radiografía
x-ray



la sala de urgencias
emergency room



la planta
ward



la silla de ruedas
wheelchair

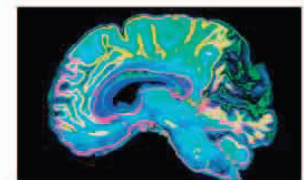

el ultrasonido
(^cla ecografía)
scan

vocabulario • vocabulary

la operación
operation

dado de alta
discharged

las horas de visita
visiting hours

la sala de maternidad
maternity ward

la unidad de
cuidados intensivos
intensive care unit

internado
(^cingresado)
admitted

la clínica
clinic

la sala de pediatría
children's ward

la habitación privada
private room

el paciente externo
outpatient

los servicios • departments



la otorrinonaringología
Ear, Nose, and Throat



la cardiología
cardiology



la ortopedia
orthopedics



la ginecología
gynecology



la fisioterapia
physiotherapy



la dermatología
dermatology



la pediatría
pediatrics



la radiología
radiology



la cirugía
surgery



la maternidad
maternity



la psiquiatría
psychiatry



la oftalmología
ophthalmology

vocabulario • vocabulary

la neurología
neurology

la urología
urology

la cirugía plástica
plastic surgery

la patología
pathology

el resultado
result

la oncología
oncology

la endocrinología
endocrinology

la referencia
(^cel volante)
referral

el análisis
test

el especialista
consultant

el dentista • dentist

el diente • tooth

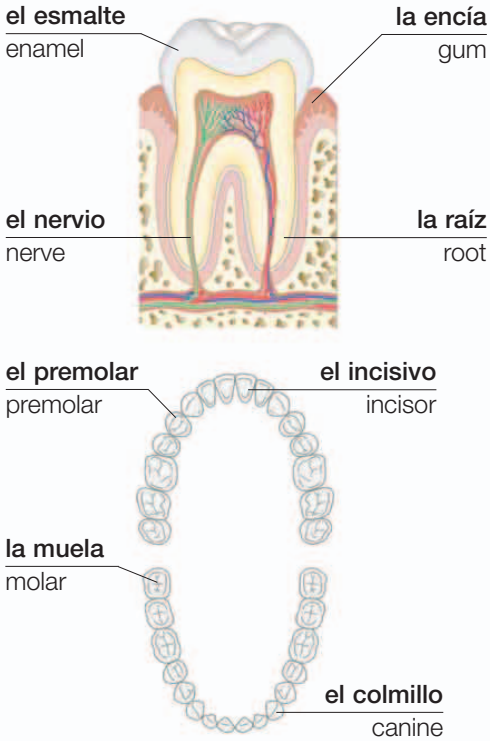

la revisión • check-up



vocabulario • vocabulary

el dolor de muelas toothache	el hilo dental dental floss
la placa bacteriana plaque	la extracción extraction
la caries decay	la corona crown
el empaste filling	el torno del dentista drill



usar el hilo dental
floss (v)



cepillarse los dientes
brush (v)



los frenos ([©] el aparato corrector)
braces



los rayos x dentales
dental x-ray



la radiografía
x-ray film



la dentadura postiza
dentures

el óptico • optician



el examen de ojos | eye test

el estuche
(^c la funda)
case



los lentes
glasses

el cristal
lens



los lentes oscuros
(^c las gafas de sol)
sunglasses

la montura
frame

el líquido limpiador
cleaning fluid



la solución
desinfectante
disinfectant solution

el estuche para
los pupiletas
(^c las lentillas)
lens case



los pupiletas (^c las lentes de contacto) | contact lenses

el ojo • eye

la ceja
eyebrow

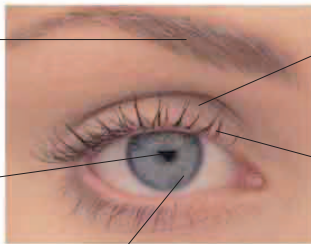

el párpado
eyelid

la pupila
pupil

la pestaña
eyelash

el iris
iris

la retina
retina

el cristalino
lens

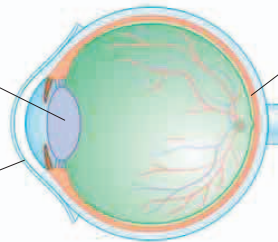

el nervio óptico
optic nerve

la córnea
cornea

vocabulario • vocabulary

la vista
vision

el astigmatismo
astigmatism

la dioptría
diopter

la hipermetropía
farsighted

la lágrima
tear

la miopía
nearsighted

la catarata
cataract

bifocal
bifocal

el embarazo • pregnancy



la prueba del embarazo
pregnancy test

el ultrasonido (c la ecografía)
scan



el ultrasonido | ultrasound

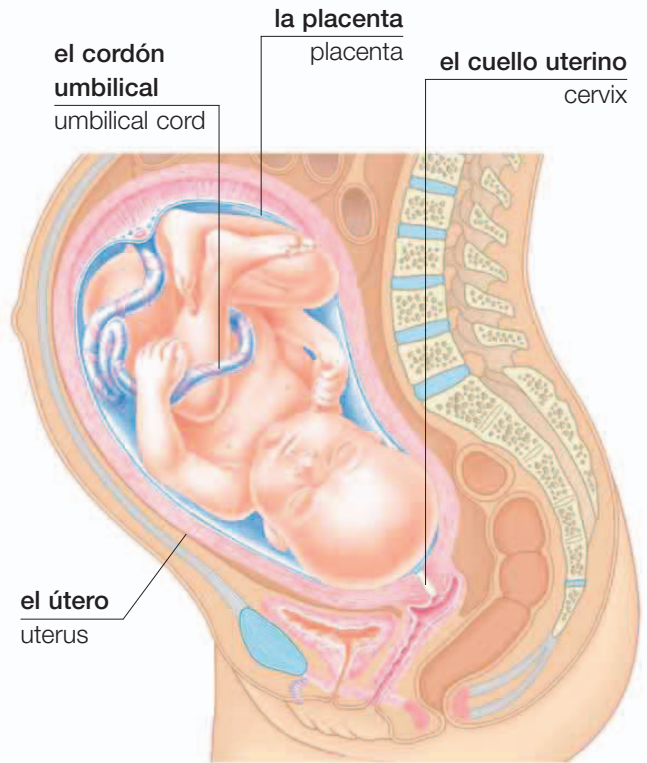

el cordón umbilical
umbilical cord

la placenta
placenta

el cuello uterino
cervix

el útero
uterus

el feto | fetus

vocabulario • vocabulary

la ovulación ovulation	prenatal antenatal	la contracción contraction	la dilatación dilation	el parto delivery	premature premature
la concepción conception	el trimestre trimester	romper aguas break water (v)	la epidural epidural	el nacimiento birth	el ginecólogo gynecologist
embarazada (c encinta) expectant	el embrión embryo	el líquido amniótico amniotic fluid	la cesárea cesarean section	el aborto espontáneo miscarriage	el obstetra (c el tocólogo) obstetrician
embarazada pregnant	la matriz womb	la amniocentesis amniocentesis	la episiotomía episiotomy	las puntadas (c los puntos) stitches	de espaldas (c de nalgas) breech

el parto • childbirth

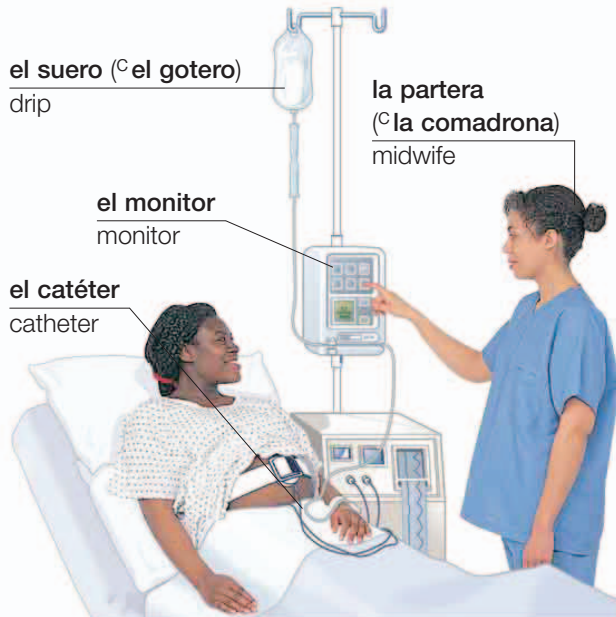

el suero (° el gotero)
drip

la partera
(° la comadrona)
midwife

el monitor
monitor

el catéter
catheter

inducir el parto
induce labour (v)



la incubadora | incubator



el peso al nacer
birth weight

los fórceps
forceps

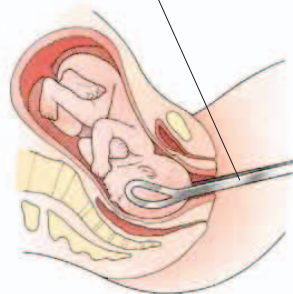

el parto asistido
assisted delivery

la ventosa
suction cup

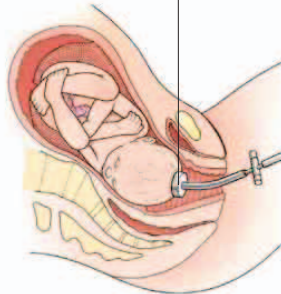

la pulsera de identificación
identity tag



el recién nacido
newborn baby

la lactancia • nursing



el tiraleches
(° el sacaleches)
breast pump



el brassiere (° el sujetador) **para la lactancia**
nursing bra



amamantar
(° dar el pecho)
breastfeed (v)



los discos protectores
pads

las terapias alternativas • alternative therapy



el yoga | yoga



el masaje
massage



el shiatsu
shiatsu



la quiropráctica
chiropractic



la osteopatía
osteopathy



la reflexología
reflexology



la meditación
meditation

el terapeuta
counselor



la terapia de grupo
group therapy



el reiki
reiki



la acupuntura
acupuncture



la ayurveda
ayurveda



la hipnoterapia
hypnotherapy

los aceites esenciales
essential oils



el herbolario
herbalism



la aromaterapia
aromatherapy



la homeopatía
homeopathy



la acupresión
acupressure

la terapeuta
therapist



la psicoterapia
psychotherapy

vocabulario • vocabulary

la cristaloterapia
crystal healing

la naturopatía
naturopathy

la relajación
relaxation

la hierba
herb

la hidroterapia
hydrotherapy

el feng shui
feng shui

el estrés
stress

el suplemento
supplement





la casa
home

la casa • house

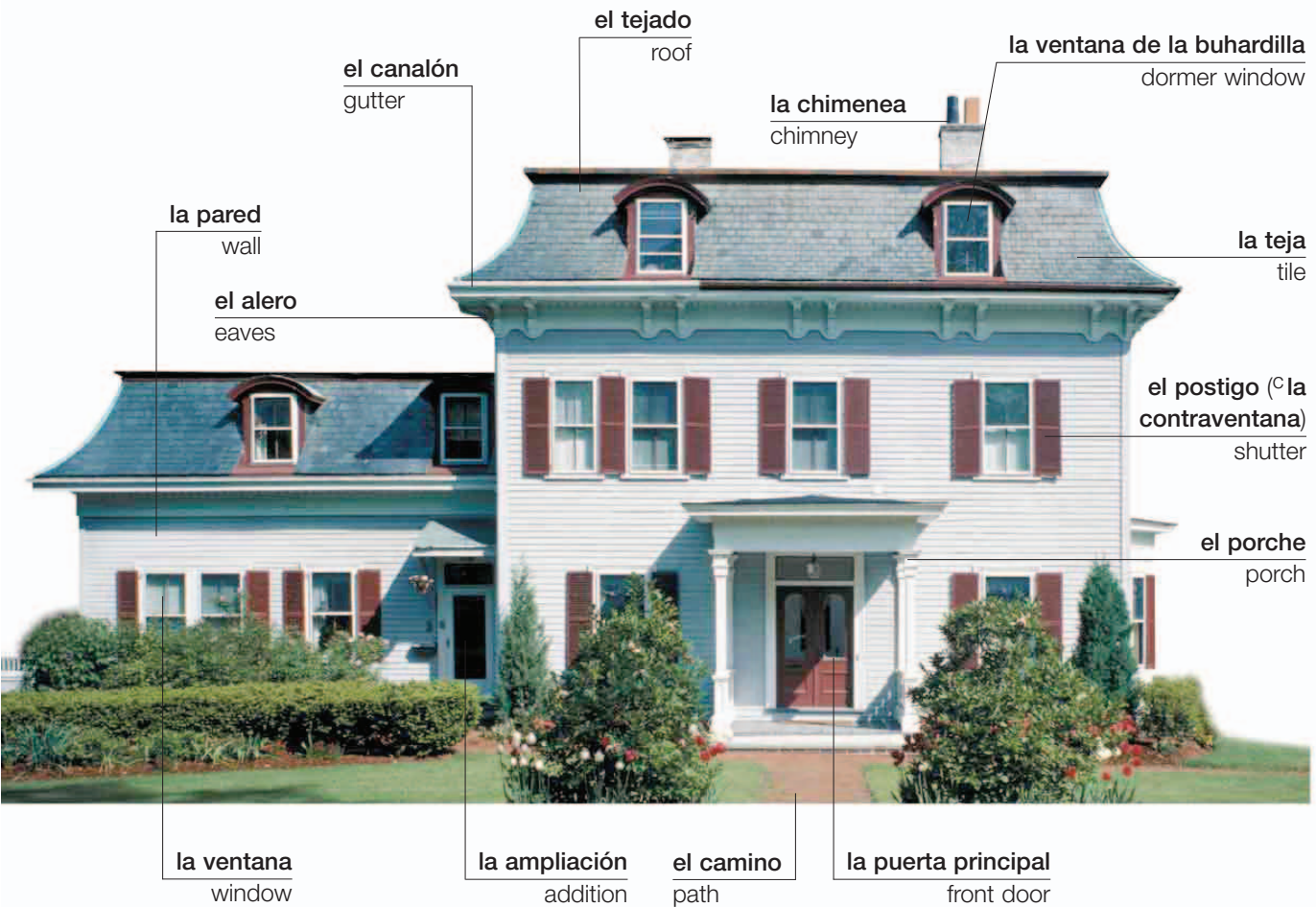

vocabulario • vocabulary

(condominio) horizontal
row (house)

la casa de la ciudad
townhouse

la cochera
(^oel garaje)
garage

la luz del porche
porch light

la alarma antirrobo
burglar alarm

rentar
(^oalquilar)
rent (v)

solo
single-family

el sótano
basement

el ático
attic

el piso
floor

el buzón
mailbox

el inquilino
tenant

dúplex
duplex

la vivienda de una planta
bungalow

el cuarto
(^ola habitación)
room

el patio
courtyard

el propietario
landlord

la renta
(^oel alquiler)
rent

la entrada • entrance

el departamento
(^c el piso) •
apartment

el balcón
balcony



el edificio
apartment block



el interfono
intercom



el elevador (^c el ascensor)
elevator



el
pasamanos
hand rail

la escalera
staircase

el descanso
(^c el descansillo)
landing

el barandal
(^c la barandilla)
banister

el vestíbulo
hallway



el timbre
doorbell



el tapete (^c el felpudo)
doormat



la aldaba
door knocker



la cadena
door chain

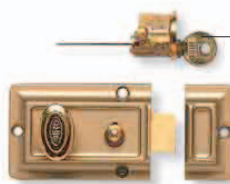

la cerradura
lock

la llave
key



el cerrojo
bolt

las instalaciones internas • internal systems



el radiador
radiator



el calentador (°C la estufa)
space heater



el aspa
blade

el ventilador
fan



el calentador de convección
portable heater

la electricidad • electricity



el filamento
filament

la bombilla de ahorro de energía
energy-saving bulb

la toma de tierra
ground

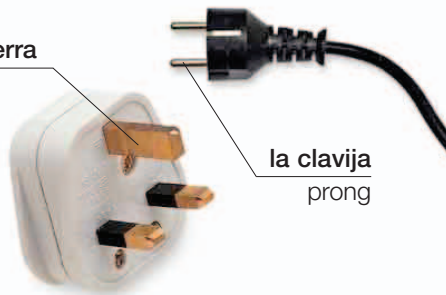

el enchufe (macho)
plug

la clavija
prong

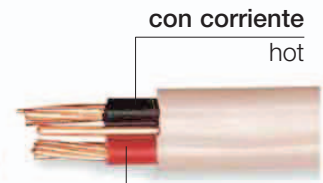

con corriente
hot

neutro
neutral

los cables
wires

vocabulario • vocabulary

el voltaje
voltage

el generador
generator

el enchufe (hembra)
socket

la corriente continua
direct current

el transformador
transformer

el amperio
amp

el fusible
fuse

el interruptor
switch

el contador de la luz
electric meter

el suministro de electricidad
household current

la corriente eléctrica
power

la caja de los fusibles
fuse box

la corriente alterna
alternating current

el corte de luz
power outage

la fontanería • plumbing

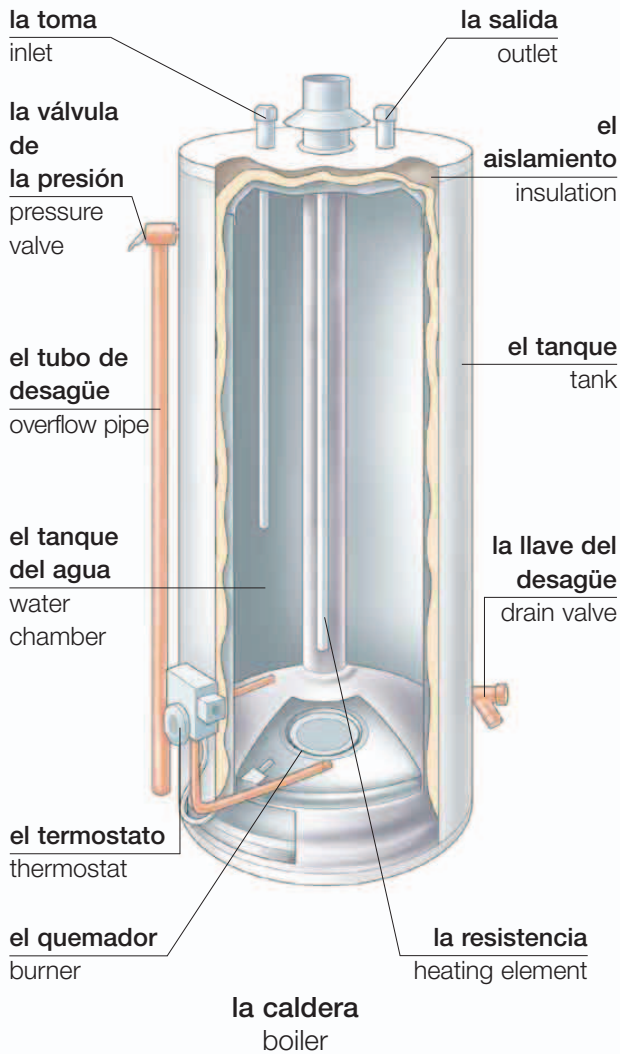

el fregador • sink

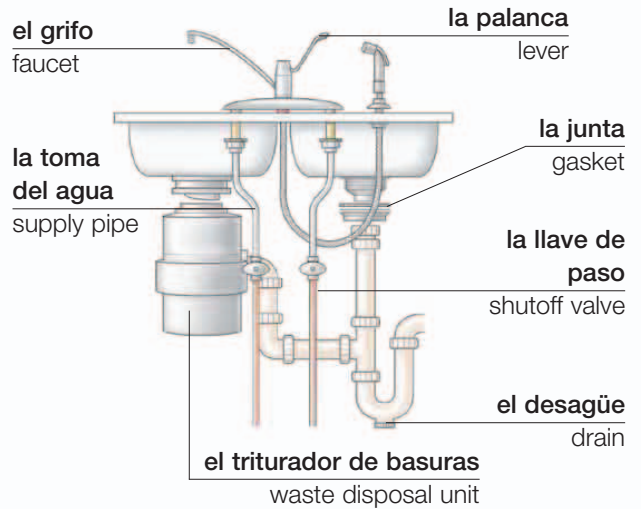

el retrete • toilet

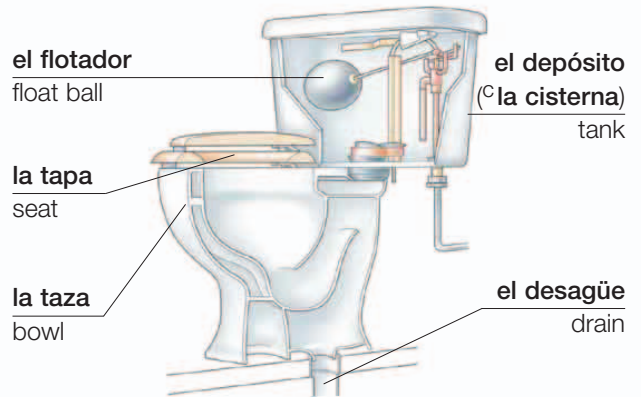

la eliminación de desechos • waste disposal



la sala (el cuarto de estar) • living room

el techo
ceiling

la lámpara
lamp

el jarrón
vase

el cojín
pillow

la mesa de
centro (la
mesa de
café)
coffee table

el sofá
sofa

el piso
(el suelo)
floor

el arbotante
(el aplique)
wall light

la chimenea
fireplace



el marco
frame



el cuadro
painting

el librero
([©] la estantería)
bookshelf

el sofá-cama
sofabed

el tapete
([©] la alfombra)
rug



la cortina
curtain



el visillo
net curtain



la persiana ([©] el estor
de láminas)
venetian blind



el estor
roller blind

la moldura
molding

el sillón
armchair



el estudio ([©] el despacho) | study

el comedor • dining room



vocabulario • vocabulary

servir
serve (v)

la comida
meal

el desayuno
breakfast

hambriento
hungry

el anfitrión
host

Estaba riquísimo.
(c **Estaba buenísimo.**)
That was delicious.

comer
eat (v)

el mantel
tablecloth

la comida
lunch

lleno
full

la anfitriona
hostess

Estoy lleno, gracias.
I've had enough, thank you.

poner la mesa
set the table (v)

el mantel individual
place mat

la cena
dinner

la ración
portion

el invitado
guest

¿Puedo comer otro poco?
(c **¿Puedo repetir?**)
May I have some more?

la vajilla y los cubiertos • crockery and cutlery



la taza
mug



la taza de café
coffee cup



la taza de té
teacup

la cucharilla de café
teaspoon



el plato
plate



el plato sopero
(^cel bol)
bowl



la cafetera de émbolo
French press



la tetera
teapot



la jarra
pitcher



la taza para el huevo
(^cla huevera)
egg cup

la copa de vino
wine glass



el vaso
tumbler

la cristalería
glassware

el servilletero
napkin ring

el plato del pan
dessert plate

el plato
(^cel plato llano)
dinner plate

el plato sopero
soup bowl

la cuchara sopera
soup spoon



la servilleta
napkin



el tenedor
fork



el lugar en la mesa
place setting



la cuchara
spoon

el cuchillo
knife

la cocina • kitchen



los electrodomésticos • appliances



la máquina de los hielos

ice maker



el refrigerador

(^o el frigorífico)

refrigerator

la charola

(^o el estante)

shelf

el cajón de las verduras

crisper

el congelador

freezer

vocabulario • vocabulary

el escurridor • **congelar**
draining board freeze (v)

el quemador • **descongelar**
burner defrost (v)

el bote de basura • **cocer al vapor**
garbage can steam (v)

la hornilla • **saltear**
(^o la placa) sauté (v)

stove

el refrigerador (^o frigorífico) congelador | refrigerator-freezer c

cocinar • cooking



pelar
peel (v)



cortar
slice (v)



rallar
grate (v)



vaciar (^o echar)
pour (v)



mezclar
mix (v)



batir
whisk (v)



hervir
boil (v)



freír
fry (v)



amasar (^o extender)
con el rodillo | roll (v)



remover
stir (v)



cocer a fuego lento
simmer (v)



escalfar
poach (v)



hornear
(^o cocer al horno)
bake (v)



asar
roast (v)



asar a la parrilla
grill (v)

los utensilios de cocina • kitchenware



la tabla para cortar
cutting board

el cuchillo de sierra
bread knife



el cuchillo de cocina
paring knife



el hacha de cocina
meat cleaver



el afilador
knife sharpener



el mazo de cocina
meat tenderizer



el pincho
skewer



el rallador
grater



la mano de mortero
pestle



el machacador
(^oel mazo para puré de patatas)
masher



el pelador
(^oel mondador)
peeler



el descorazonador
apple corer



el abrelatas
can opener



el destapador
(^oel abrebotellas)
bottle opener



el exprimidor de ajos
(^oel prensaajos)
garlic press



la cuchara de servir
serving spoon



la pala
fish spatula



el escurridor
colander



la espátula
spatula



la cuchara de madera
wooden spoon



la espumadera
mesh skimmer



el cucharón
ladle



el trinche
(^oel tenedor para trinchar)
carving fork



la cuchara para helado
ice-cream scoop



el globo para batir
(^oel batidor de varillas)
whisk



el colador
strainer



la repostería • baking cakes

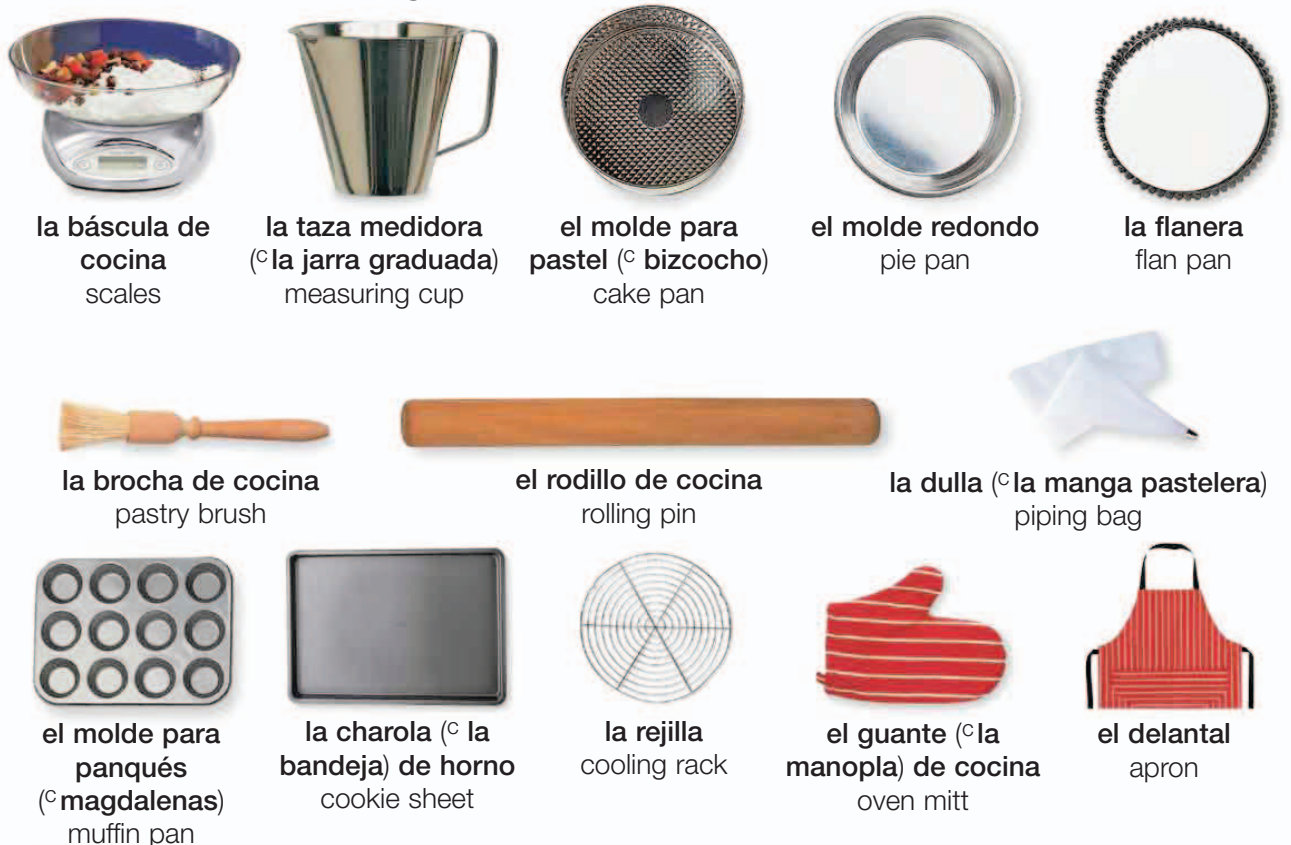

la recámara • bedroom

el armario
wardrobe

la lámpara del buró (° de la mesilla)
bedside lamp

la cabecera (° el cabecero)
headboard

el buró (° la mesilla de noche)
nightstand

la cómoda
chest of drawers



el cajón
drawer

la cama
bed

el colchón
mattress

la colcha
bedspread

la almohada
pillow



la bolsa de agua caliente
hot-water bottle



la radio despertador
clock radio



el reloj despertador
alarm clock



la caja de pañuelos desechables
box of tissues



el gancho (° la percha)
coat hanger

la ropa de cama • bed linen



el espejo
mirror

el tocador
vanity table

el suelo
floor



la funda de la
almohada
pillowcase

la sábana
sheet

el cubrecanapé
valance

el edredón
comforter

la colcha
quilt

la cobija
(^o la manta)
blanket



vocabulario • vocabulary

la cama individual
single bed

el pie de la cama
(^o el estribo)
footboard

el insomnio
insomnia

despertarse
wake up (v)

roncar
snore (v)

la cama
matrimonial
(^o de matrimonio)
double bed

el resorte
(^o el muelle)
box spring

acostarse
go to bed (v)

levantarse
get up (v)

poner el
despertador
set the alarm (v)

la cobija (^o la
manta) eléctrica
electric blanket

el tapete
(^o la moqueta)
carpet

dormirse
go to sleep (v)

hacer la cama
make the bed (v)

el armario
empotrado
closet

el cuarto de baño • bathroom

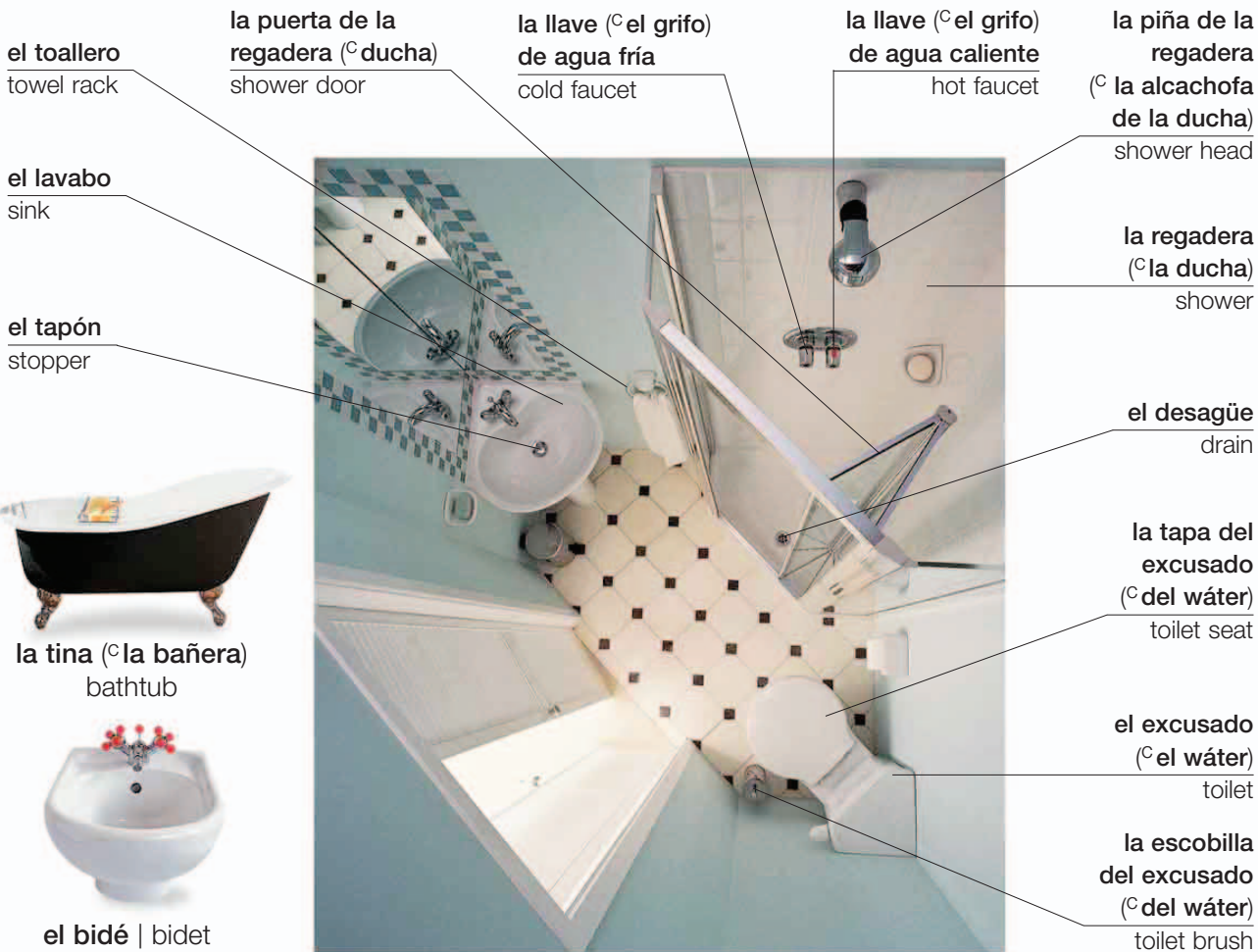

vocabulario • vocabulary

- | | |
|---|--|
| el botiquín (el armario de las medicinas)
medicine cabinet | el tapete (la alfombrilla de baño)
bathmat |
| el rollo de papel higiénico
toilet paper | la cortina de la regadera (de ducha)
shower curtain |
| bañarse (darse una ducha)
take a shower (v) | darse un baño
take a bath (v) |

la higiene dental • dental hygiene



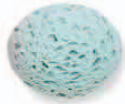

la esponja
sponge



la piedra pómez
pumice stone



el cepillo para la espalda
back brush



el desodorante
deodorant

la jabonera
soap dish



el jabón
soap

el shampoo para el cuerpo
(^oel gel de ducha)
shower gel



la crema para la cara
face cream



el gel de baño
bubble bath



la bata
(^oel albornoz)
bathrobe

la toalla de mano
(^ode lavabo)
hand towel



las toallas
towels

la toalla de baño
bath towel



la crema para el cuerpo
(^ola leche del cuerpo)
body lotion



el talco (^olos polvos de talco)
talcum powder

el afeitado • shaving



la rasuradora
electric razor



la espuma de afeitado
shaving cream



la navaja de afeitado desechable
disposable razor



la hoja de afeitado
razor blade



el aftershave
aftershave

la habitación de los niños • nursery

el cuidado del bebé • baby care



la esponja
sponge

la crema para las
rozaduras (c las
escoceduras)
diaper rash cream

la tina de plástico
baby bath



la toallita
húmeda
wet wipe

el orinal
potty



el cambiador
changing mat

la hora de dormir • sleeping



el móvil
mobile

los barrotes
bars

el colchón
mattress

la cuna | crib

la sábana
sheet

la cobija (c la manta)
blanket

el vellón
fleece

la ropa de cama
bedding

el protector
(c la chichonera)
bumper



la sonaja (c el sonajero)
rattle



el moisés
moses basket

los juegos • playing



la seguridad • safety

el cierre de seguridad
child latches



la pelota
ball



la comida • eating



el paseo • going out



la lavandería (c el lavadero) • utility room

la colada • laundry

la ropa sucia
dirty laundry



el cesto de la
ropa sucia
(c de la colada)
laundry basket



la lavadora
washing machine



la lavadora
secadora
washer-dryer



la secadora
tumble dryer

la ropa limpia
clean clothes



el cesto de la
ropa para
planchar
linen basket

la pinza para la
ropa
clothespin



secar
dry (v)

el tendedero
(c la cuerda para
tender la ropa)
clothesline



el burro (c la tabla) de la plancha | ironing board



la plancha
iron

vocabulario • vocabulary

cargar
load (v)

centrifugar
spin (v)

planchar
iron (v)

¿Cómo funciona la lavadora?
How do I operate the washing machine?

aclarar
rinse (v)

la centrífuga
(c la centrifugadora)
spin dryer

el suavizante
fabric conditioner

¿Cuál es el programa para la ropa de
color/blanca?
What is the setting for colors/whites?

el equipo de limpieza • cleaning equipment



las acciones • activities

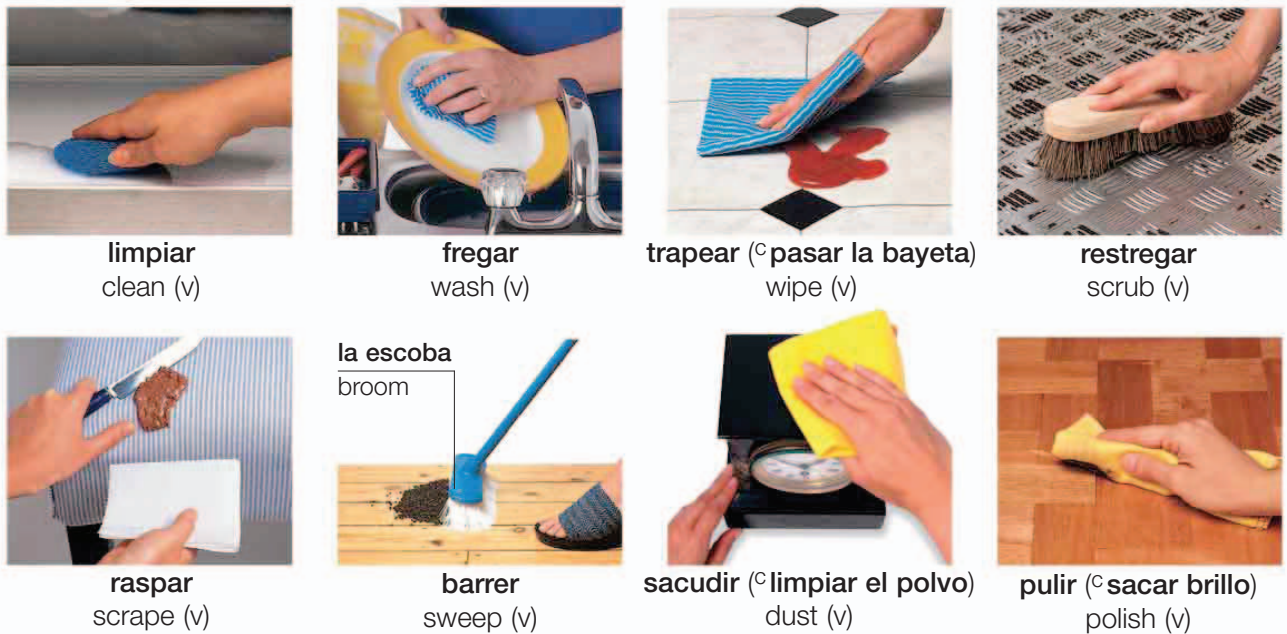

el taller • workshop



la sierra de vaivén
jigsaw



la batería
battery pack

el taladro inalámbrico
rechargeable drill



el cabezal
chuck

el taladro eléctrico
electric drill



la broca
drill bit



la pistola para encolar
glue gun



el tornillo (° el torno)
de banco | vise

la abrazadera
clamp



la lijadora
sander

la cuchilla
blade

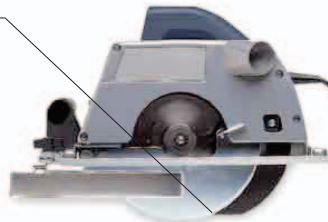

la sierra circular
circular saw



el banco de trabajo
workbench

el pegamento (° la
cola) de carpintero
wood glue

la guimbarda
router

las virutas de madera
wood shavings



el organizador de
las herramientas
tool rack

el taladro manual
bit brace

la extensión
(° el alargador)
extension cord

las técnicas • techniques

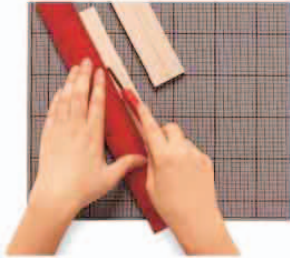

cortar
cut (v)



serrar
saw (v)



taladrar
drill (v)



clavar
hammer (v)



cepillar (° alisar)
plane (v)



tornear
turn (v)



la soldadura
(° el hilo de estaño)
solder

tallar
carve (v)

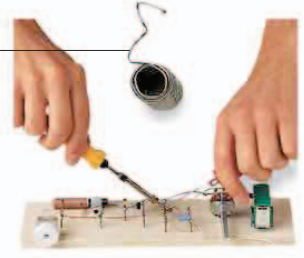

soldar
solder (v)

los materiales • materials

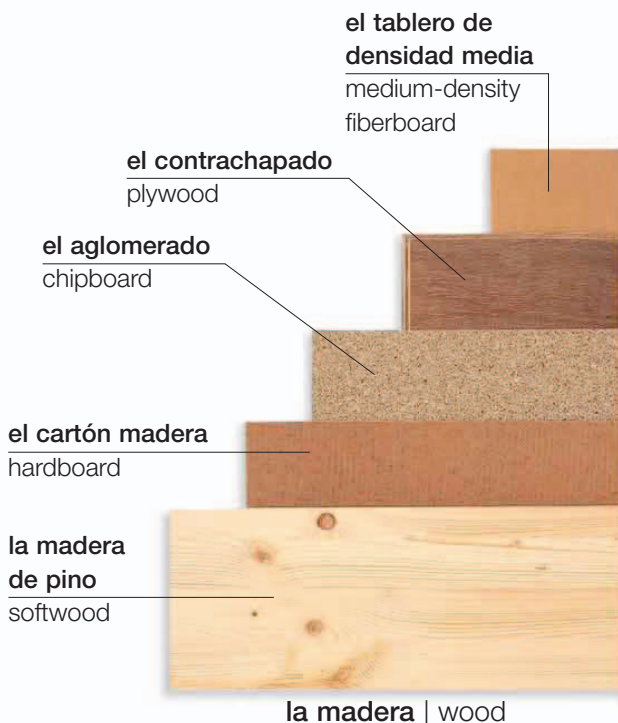

la caja de las herramientas • toolbox

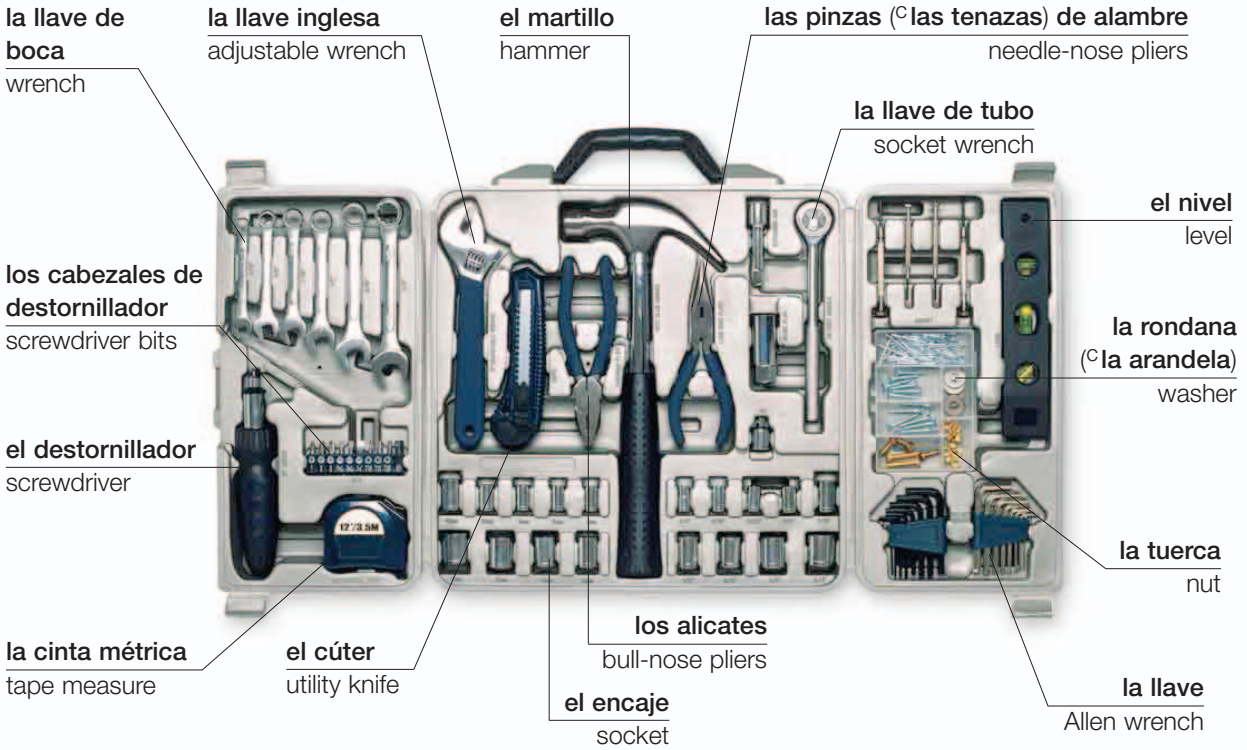

las brocas • drill bits

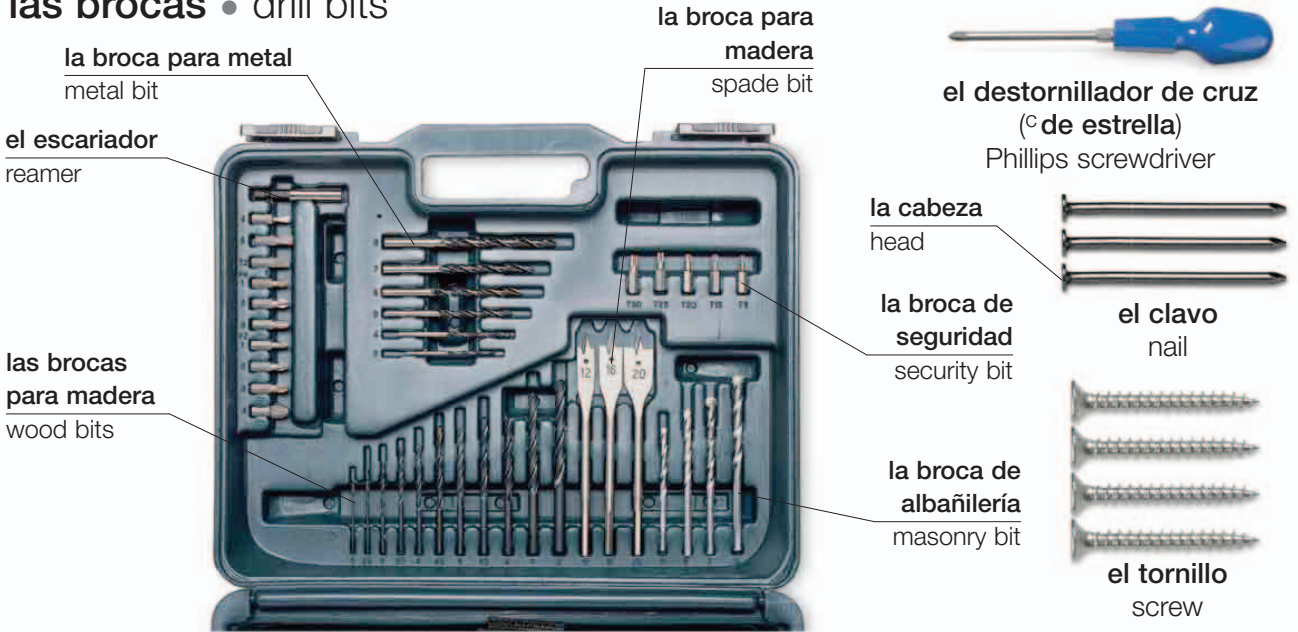

el pelacables
wire strippers

el cortaalambres
wire cutter

el soldador
soldering iron

la cinta aislante
electrical tape

la soldadura
solder

el escalpelo
hobby knife

la sierra de calar
fretsaw

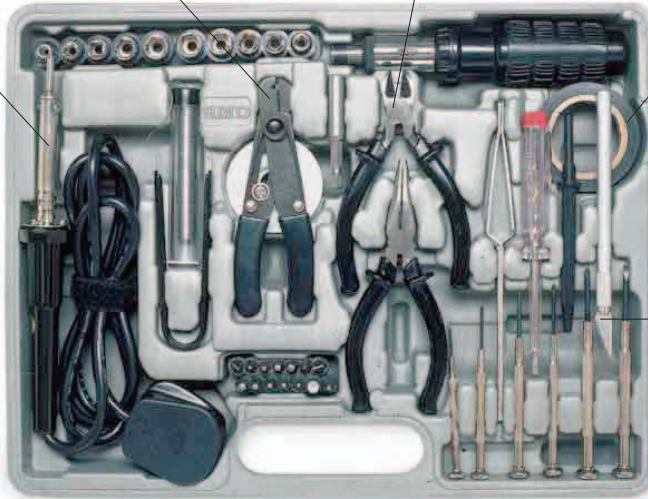

el serrucho de costilla | tenon saw



las gafas de seguridad
safety goggles



el cepillo
plane



la caja para cortar en inglete
miter block



el serrucho
handsaw



el taladro manual
hand drill



la lana de acero
steel wool



la sierra para metales
hacksaw



el papel de lija
sandpaper

las tenazas
pipe wrench



el formón
chisel



la piedra afiladora
sharpening stone

el destapacaños
(^oel desatascador)
plunger



la lima
file



el cortatuberías | pipe cutter



la decoración • decorating



las tijeras
scissors



el cúter
craft knife



la plomada
(^cla cuerda de plomada)
plumb line



la espátula (^cel raspador)
scraper

el pintor
decorator

el papel tapiz
(^cel papel pintado)
wallpaper

la escalera de
mano
stepladder



tapizar (^cempapelar) | wallpaper (v)

la brocha de
tapicero
(^cempapelador)
wallpaper brush

la mesa de
encolar
pasting table

la brocha de
encolar
pasting brush

el pegamento
para tapizar
(^cla cola para
empapelar)
wallpaper paste

la cubeta
(^cel cubo)
bucket



despegar (^carrancar)
strip (v)



rellenar
fill (v)



lijar
sand (v)



enyesar | plaster (v)



empapelar | hang (v)



poner azulejos (^calicatar) | tile (v)



pintar
paint (v)

el rodillo
roller

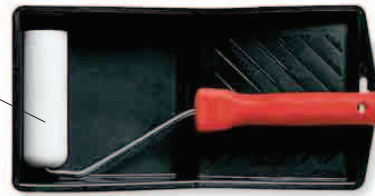

la bandeja para la pintura
paint tray

la brocha
brush



la pintura
paint

la lata de pintura
paint can



la esponja
sponge



el masking tape (°la cinta adhesiva protectora)
masking tape



el papel de lija
sandpaper

el overol (°el mono)
coveralls



el mastique (°la masilla)
filler

la trementina
turpentine



el aguarrás
paint thinner

el protector
oilcloth

vocabulario • vocabulary

el yeso
plaster

con brillo
gloss

el papel de apresto
lining paper

la primera mano
base coat

el conservante
preservative

el barniz
varnish

mate
matte

la plantilla
stencil

la última mano
top coat

el cemento blanco
grout

la pintura al agua
latex paint

la base (°la imprimación)
primer

el papel estampado en relieve
embossed paper

el solvente (°el disolvente)
solvent

el sellador (°el sellante)
sealant

el jardín • garden

los estilos de jardín • garden styles



el patio con jardín (c) la terraza ajardinada
patio garden



el jardín en la azotea
roof garden



la rocalla
rock garden



el patio
courtyard



el jardín campestre
English garden



el jardín de plantas herbáceas
herb garden



el jardín acuático
water garden

los adornos para el jardín • garden features



la cesta colgante
hanging basket



la enredadera (c) la espaldera | trellis



la pérgola
arbor

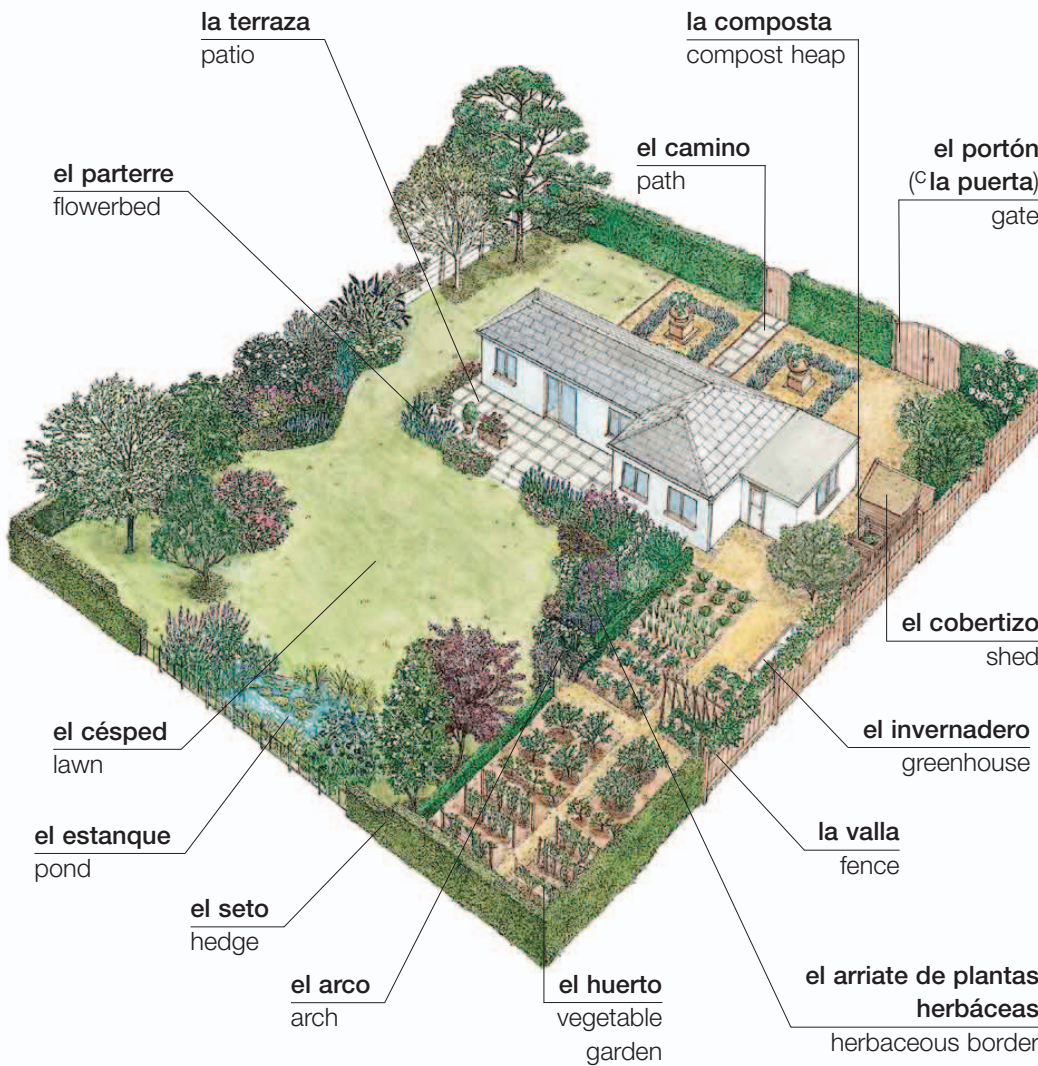

la tierra • soil



la capa superior de la tierra
topsoil



la arena
sand



la creta
chalk



el cieno
silt



la arcilla
clay



el entarimado
deck



la fuente | fountain

las plantas de jardín • garden plants

los tipos de plantas • types of plants



anual
annual



bienal
biennial



perenne
perennial



el bulbo
bulb



el helecho
fern



el junco
cattail



el bambú
bamboo



las malas hierbas
weeds



la hierba
herb



la planta acuática
water plant



el árbol
tree



de hoja caduca
deciduous



la palmera
palm



la conífera
conifer



de hoja perenne
evergreen



as plantas podadas
con formas
topiary



la planta alpestre
alpine



la planta suculenta
succulent



el cactus
cactus

la planta de maceta
potted plant

la planta de sombra
shade plant

la planta
trepadora
climber

el arbusto de
flor
flowering shrub

a planta para
cubrir suelo
ground cover



la planta trepadora
creeper

ornamental
ornamental

el pasto
(el césped)
grass

las herramientas de jardinería • gardening tools



la pala
shovel



el trinche
([©]la horca)
fork



la podadera de
mango largo
long-handled shears



el rastrillo para el
pasto ([©]el césped)
lawn rake



el rastrillo
rake



el azadón
([©]la azada)
hoe



la composta ([©]el
abono compuesto)
compost



las semillas
seeds

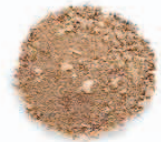

la harina de
huesos
bone meal



la grava
gravel

la bolsa para la hierba
grass bag

el motor
motor

el asa
handle

la cesta de jardinero
gardening basket

el protector
shield

el soporte
stand

la cortadora ([©]el guarnecedor)
trimmer

la podadora ([©]el cortacésped)
lawnmower

la carretilla
wheelbarrow



el trinche (° la horquilla)
hand fork



la pala pequeña
trowel

la hoja
blade



las tijeras (° la cizalla)
shears



la sierra de mano
hand saw



las podadoras (° las tijeras de podar)
pruning shears



el semillero
seed tray



el pesticida
pesticide

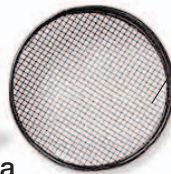

la criba
sieve



las cañas
canes

el hilo de bramante
twine

las etiquetas
labels

el alambre
twist ties

las anillas
ring ties



las botas de goma
rubber boots



la maceta
plant pot

el riego • watering



el pulverizador
spray gun



el aspersor
sprinkler

la boquilla
nozzle

la regadera
watering can

la piña
(° la alcachofa)
rose

la manguera
hose

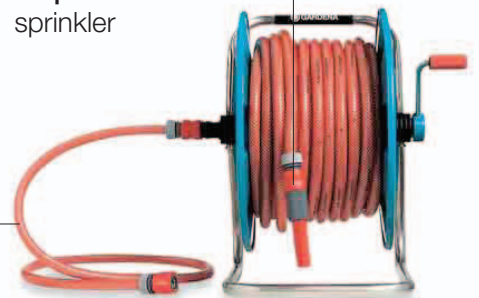

el enrollador de manguera | hose reel

la jardinería • gardening

el pasto
(^c el césped)
lawn

el seto
hedge

el parterre
flowerbed

la podadora
(^c el corta-
césped)
lawnmower

la estaca
stake



cortar el césped | mow (v)



poner césped
turf (v)



hacer agujeros con la
trinche (^c la horquilla)
spike (v)



rastrillar
rake (v)



podar
trim (v)



cavar
dig (v)



sembrar
sow (v)



abonar en la superficie
top dress (v)



regar
water (v)



guiar
train (v)



quitar las flores muertas
deadhead (v)

rociar
spray (v)



la caña
cane



injertar
graft (v)



el esqueje
cutting

propagar
propagate (v)



podar
prune (v)

apuntalar
stake (v)



transplantar
transplant (v)



escardar
weed (v)



cubrir la tierra
mulch (v)



cosechar
harvest (v)

vocabulario • vocabulary

cultivar
cultivate (v)

diseñar
landscape (v)

abonar
fertilize (v)

cribar
sieve (v)

el drenaje
drainage

el plantón
seedling

el subsuelo
subsoil

cuidar
tend (v)

plantar en tiesto
pot (v)

coger
pick (v)

airear
aerate (v)

orgánico
(^c **biológico**)
organic

el abono
fertilizer

el herbicida
weedkiller



los servicios
services

los servicios de emergencia • emergency services

la ambulancia • ambulance



la ambulancia
ambulance



la camilla
stretcher

el paramédico (°el ambulancero)
paramedic

la policía • police



la placa
badge

el uniforme
uniform

la sirena
siren

las luces
lights



la patrulla (°el coche de policía)
police car



la estación de policía
police station

la macana
(°la porra)
nightstick

la
pistola
gun



las esposas
handcuffs

el policía (°el agente de policía)
police officer

vocabulario • vocabulary

el inspector captain	el robo burglary	la denuncia complaint	el arresto arrest
el detective detective	la agresión assault	la investigación investigation	la celda lockup
el crimen crime	huella digital (°dactilar) fingerprint	el sospechoso suspect	el cargo charge

los bomberos • fire department



el incendio | fire



la estación (el parque) de bomberos
fire station



la escalera (la salida) de incendios
fire escape



el casco
helmet

el humo
smoke

la manguera
hose

la cesta
cherry picker

el chorro de agua
water jet

los bomberos
firefighters

el brazo
boom

la escalera
ladder

la cabina
cab

el carro (el coche) de bomberos
fire engine



el detector de humo
smoke alarm



la alarma contra incendios
fire alarm



el hacha
ax



el extintor
fire extinguisher



la bomba (la boca) de agua
hydrant

<p>Necesito la policía/los bomberos/una ambulancia. I need the police/fire department/ambulance.</p>	<p>Hay un incendio en... There's a fire at...</p>	<p>Ha habido un accidente. There's been an accident.</p>	<p>¡Llame a la policía! Call the police!</p>
---	--	---	---

el banco • bank

el cliente
customer

la ventanilla
window

el cajero
teller



los folletos
brochures

el mostrador
counter

las fichas de depósito (c las hojas de ingreso)
deposit slips

la tarjeta de débito
debit card

la matriz
stub

el número de cuenta
account number

la firma
signature

la cantidad
amount



el gerente del banco
(c el director de banco)
branch manager

la tarjeta de crédito
credit card

el talonario de cheques
checkbook

el cheque
check

vocabulario • vocabulary

los ahorros
savings

la hipoteca
mortgage

el pago
payment

depositar
deposit (v)

la cuenta corriente
checking account

el sobregiro
(c el descubierto)
line of credit

la tasa (c el tipo)
de interés
interest rate

la ficha de retiro
withdrawal slip

el pin
pin number

la cuenta de ahorros
savings account

el préstamo
loan

los impuestos
tax

el débito directo
(c la domiciliación
bancaria)
automatic bill
payment

la transferencia
bancaria
direct deposit

la comisión del
banco
service charge

la moneda

coin



el billete
bill

el dinero
money

la pantalla

screen

el teclado

keypad



la ranura
de la tarjeta
card reader

el cajero automático
ATM

las divisas • foreign currency



la oficina de cambio
currency exchange



el cheque de
viajero (° de viaje)
traveler's check



el tipo de
cambio
exchange rate

vocabulario • vocabulary

cobrar
cash (v)

las acciones
stocks

la denominación
(° el valor nominal)
denomination

el contador
(° el contable)
accountant

la comisión
commission

los dividendos
dividends

la inversión
investment

la cartera
portfolio

las acciones
securities

el patrimonio neto
equity

¿Podría cambiar esto por favor?
Can I change this, please?

¿Cómo está el tipo de cambio
hoy?
What's today's exchange rate?

las finanzas • finance

el valor de las
acciones
stock price

el agente de
bolsa
stockbroker



la asesora financiera
financial advisor



la bolsa de valores
stock exchange

las comunicaciones • communications

el empleado de correos
postal worker

la ventanilla
window

la báscula
scale

el mostrador
counter



la oficina de correos | post office

el matasellos
postmark

el timbre (° el sello)
stamp

la dirección
address

el código postal
zip code



el sobre | envelope



el cartero
mail carrier

vocabulario • vocabulary

la carta
letter

la firma
signature

el reparto
delivery

frágil
fragile

no doblar
do not bend (v)

por avión
by airmail

la recogida
pickup

el franqueo
postage

el telegrama
telegram

hacia arriba
this way up

el correo certificado
registered mail

el remitente (° el remite)
return address

el giro postal
postal order

la bolsa de correo (° la saca postal)
mailbag

el fax
fax



el buzón
mailbox



el buzón
letter slot



el paquete
parcel



la mensajería
courier

el teléfono • telephone

el auricular
handset



la contestadora
(^cel contestador
automático)
answering machine

la base
base station

el teléfono inalámbrico
cordless phone



el videoteléfono
video phone



la cabina telefónica
phone booth



el teléfono inteligente
smartphone



el teléfono móvil
mobile phone

el teclado
keypad



el auricular
receiver

las monedas devueltas
coin return

el teléfono público
payphone

vocabulario • vocabulary

la información telefónica
directory assistance

la llamada a por cobrar
(^ca cobro revertido)
collect call

marcar
dial (v)

contestar
answer (v)

el mensaje de texto (SMS)
text

el mensaje de voz
voice message

el operador
operator

la aplicación
app

cupado
(^ccomunicando)
busy

desconectado
(^capagado)
disconnected

la clave de acceso
passcode

¿Me podría dar el número de...?
Can you give me the number for...?

¿Cuál es el prefijo de larga distancia para llamar a...?
What is the area code for...?

¡Mándame un mensaje de texto!
Text me!

el hotel • hotel

el lobby (el vestíbulo) • lobby



la recepción | reception



el botones
porter

el equipaje
luggage

el diablito
(el carrito)
luggage rack



el elevador (el ascensor)
escalator



el número de la
habitación
room number

los habitaciones • rooms



la habitación sencilla
(individual)
single room



la habitación doble
double room



la habitación con dos
camas individuales
twin room



el baño (el cuarto de
baño) privado
private bathroom

los servicios • services



el servicio de
limpieza
maid service



el servicio de
lavandería
laundry service

la charola (°la bandeja) del desayuno
breakfast tray



el servicio de habitaciones | room service



el minibar
minibar



el restaurante
restaurant



el gimnasio
gym



la piscina
swimming pool

vocabulario • vocabulary

la pensión completa
full board

¿Tiene alguna habitación libre?
Do you have any vacancies?

Quiero una habitación para tres días.
I'd like a room for three nights.

la media pensión
half board

Tengo una reservación
(°reserva).
I have a reservation.

¿Cuánto cuesta la habitación por día?
What is the charge per night?

la habitación con
desayuno incluido
bed and breakfast

Quiero una habitación
sencilla (°individual).
I'd like a single room.

¿Cuándo tengo que dejar la
habitación?

When do I have to vacate the room?





las compras
shopping

el centro comercial • shopping mall

el atrio
atrium

el letrero
sign

el elevador
(^cel
ascensor)
elevator



el segundo piso
(^cla segunda
planta)
third floor

el primer piso
(^cla primera
planta)
second floor

la escalera
eléctrica
(^cmecánica)
escalator

la planta
baja
ground floor

el cliente
customer

vocabulario • vocabulary

el departamento (^cla
sección) de zapatería
shoe department

el departamento (^cla
sección) de niños
children's department

el departamento (^cla
sección) de equipajes
luggage department

el servicio al
cliente
customer services

el directorio
store directory

el vendedor
(^cel dependiente)
sales clerk

el cuarto para cambiar
a los bebés
baby changing room

los probadores
fitting rooms

los baños (^clos aseos)
rest room

¿Cuánto cuesta esto?
How much is this?

¿Puedo cambiar esto?
May I exchange this?

las tiendas departamentales • department store



la ropa de caballero
menswear



la ropa de dama
(^o de señora)
womenswear



la lencería
lingerie



la perfumería
perfumes



los cosméticos
(^o los productos de
belleza)
cosmetics



los blancos (^o la ropa
de hogar)
linens



el mobiliario para el
hogar
home furnishings



la mercería
notions



los artículos de cocina
(^o el menaje de hogar)
kitchenware



las vajillas
china



los aparatos eléctricos
electronics



la iluminación
lighting



los artículos deportivos
sportswear



la juguetería
toys



la papelería
stationery



los abarrotes
(^o el supermercado)
groceries

el supermercado • supermarket

el pasillo
aisle

el estante
shelf

la banda (c) la cinta)
transportadora
checkout counter

el cajero
cashier

las ofertas
offers



la caja | checkout

el cliente
customer

la caja
cash register

la bolsa
shopping bag



el carrito (c) el carro)
grocery cart

la compra
groceries

el asa
handle



la canasta (c) la cesta)
basket



el código de barras
bar code



el escáner
scanner



la panadería
bakery



los lácteos
dairy



los cereales
breakfast cereals



las conservas
canned goods



la dulcería
(^ola confitería)
candies



la verdura
vegetables



la fruta
fruits



la carne y las aves
meat and poultry



el pescado
fish



la charcutería
deli



los congelados
frozen food



los platos preparados
prepared food



las bebidas
drinks



los productos de limpieza
household products



los artículos de aseo
toiletries



los artículos para el bebé
baby products



los electrodomésticos
electrical goods



la comida para animales
pet food



las revistas | magazines

la farmacia • chemist

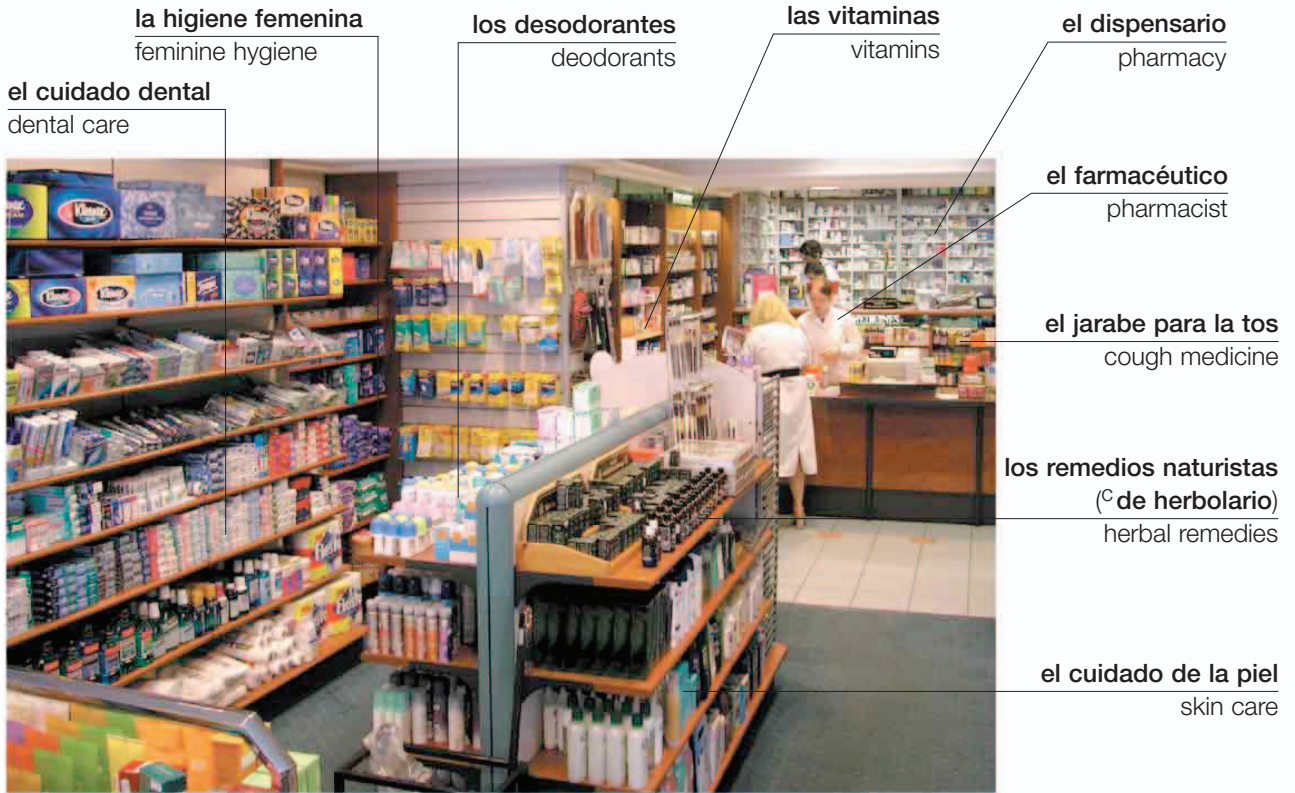

la crema para después del sol
aftersun care

la crema protectora
sunscreen



la crema protectora total
sun block



el repelente de insectos
insect repellent



a toallita húmeda
wet wipe



el pañuelo desechable
(^cde papel)
tissue



las toallas femeninas
(^cla compresa)
sanitary napkin



el tampón
tampon



el pantiprotector
(^cel salvaslip)
panty liner



la cápsula
capsule



la píldora
pill

la cuchara medidora
measuring spoon



el jarabe
syrup

el modo de empleo
instructions



el inhalador
inhaler



la crema
cream



la pomada
ointment



el gel
gel



el supositorio
suppository

el gotero
eye dropper



las gotas
eye drops



la aguja
needle

la jeringa (c la jeringuilla)
syringe



el spray
spray



los polvos
powder

vocabulario • vocabulary

el hierro
iron

el complejo vitamínico
multivitamins

desechable
disposable

el medicamento
medicine

el analgésico
painkiller

el calcio
calcium

los efectos secundarios
side-effects

soluble
soluble

el laxante
laxative

el calmante
sedative

el magnesio
magnesium

la fecha de caducidad
expiration date

la dosis
dosage

la diarrea
diarrhea

el somnífero
sleeping pill

la insulina
insulin

las píldoras para el mareo
travel sickness pills

la medicación
medication

la pastilla para la
garganta
throat lozenge

el antiinflamatorio
anti-inflammatory

la florería (la floristería) • florist

las flores
flowers

la azucena
lily

la acacia
acacia

el clavel
carnation

la maceta
potted plant



la gladiola
gladiolus

el iris
iris

la margarita
daisy

el crisantemo
chrysanthemum

la nube
(la gypsophila)
gypsophila



el alhelí
stocks



la gerbera
gerbera



el follaje
foliage



la rosa
rose



la fresia
freesia

el florero (el jarrón)

vase



la orquídea
orchid



la peonía
peony

el ramo
bunch



el tallo
stem

el narciso
daffodil

el capullo
bud



la envoltura
wrapping

el tulipán | tulip

los arreglos • arrangements



la cinta
ribbon

el ramo
bouquet



las flores secas
dried flowers



el popurrí | pot-pourri



la corona | wreath



la guirnalda
garland

¿Me da un ramo de...
por favor?
May I have a bunch of...
please.

¿Me los puede envolver?
May I have them
wrapped?

¿Puedo poner un
mensaje?
May I attach a message?

¿Los puede enviar
a...?
Would you send them
to....?

¿Cuánto tiempo
durarán éstos?
How long will these last?

¿Huelen?
Are they fragrant?

los tabacos y las revistas (c el vendedor de periódicos)

• newsstand



los cigarros
(c los cigarrillos)
cigarettes

la cajetilla de cigarros
(c el paquete de tabaco)
pack of cigarettes

los timbres
(c los sellos)
stamps



la tarjeta postal
postcard



la historieta (c el tebeo)
comic



la revista
magazine



el periódico
newspaper

fumar • smoking



el tabaco
tobacco



el encendedor (c el mechero)
lighter



la cazoleta
bowl

la pipa
pipe



el puro
cigar

la dulcería • candy store

la caja de chocolates
(^o de bombones)
box of chocolates

la barra
snack bar

las papas
(^o patatas) fritas
potato chips



la dulcería (^o la tienda de golosinas) | candy store

vocabulario • vocabulary

el chocolate de
leche
milk chocolate

el caramelo
caramel

el chocolate
negro
dark chocolate

la trufa
truffle

el chocolate
blanco
white chocolate

la galleta
cookie

los dulces (^o las
golosinas) a
granel
pick and mix

los caramelos
duros
hard candy

los dulces (^o las golosinas) • confectionery



el chocolate
(^o el bombón)
chocolate



la tablilla (^o la tableta)
de chocolate
chocolate bar



los caramelos duros
hard candy



la paleta (^o la piruleta)
lollipop



el toffee
toffee



el turrón
nougat



el malvarisco (^o la nube)
marshmallow



la pastilla de menta
mint



el chicle
chewing gum



el caramelo blando
jellybean



la gomita (^o la gominola)
gumdrop



el regaliz
licorice

las otras tiendas • other stores



la panadería
bakery



la confitería
cake shop



la carnicería
butcher shop



la pescadería
fish counter



la verdulería
produce stand



los abarros
(^cel ultramarinos)
grocery store



la zapatería
shoe store



la ferretería
hardware store



la tienda de antigüedades
antique store



la tienda de regalos
(^cde artículos de regalo)
gift store



la agencia de viajes
travel agency



la joyería
jewelry store



la librería
bookstore



la tienda de discos
record store



la tienda de licores
liquor store



la tienda de mascotas
([©]la pajarería)
pet store



la mueblería
([©]la tienda de muebles)
furniture store



la boutique
boutique



la sastrería
tailor shop



la estética ([©]la peluquería)
hair salon

vocabulario • vocabulary

el vivero garden center	la tienda de fotografía camera store
la tienda naturista ([©] la herboristería) health food store	la tienda de artículos usados second-hand store
la lavandería laundromat	la tintorería dry cleaner
la agencia inmobiliaria realty office	la galería de arte ([©] la tienda de materiales de arte) art store



el mercado | market



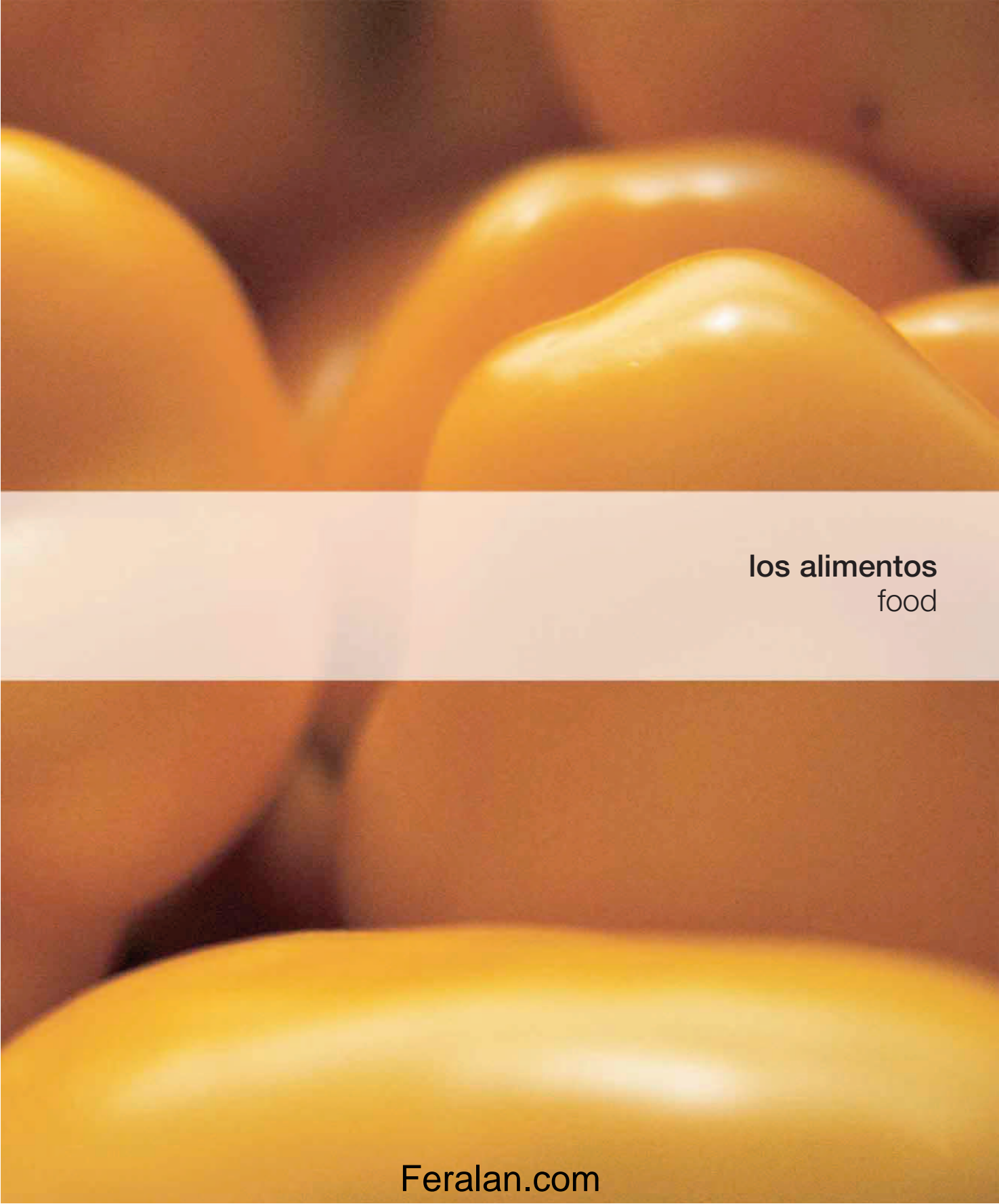

los alimentos
food

la carne • meat



vocabulario • vocabulary

el cerdo
pork

el venado
venison

las asaduras
offal

de granja
free range

la carne roja
red meat

la vaca
beef

el conejo
rabbit

curado
cured

la carne blanca
white meat

la carne magra
lean meat

la ternera
veal

la lengua
tongue

ahumado
smoked

orgánico (el biológico)
organic

el fiambre
cooked meat

los cortes • cuts

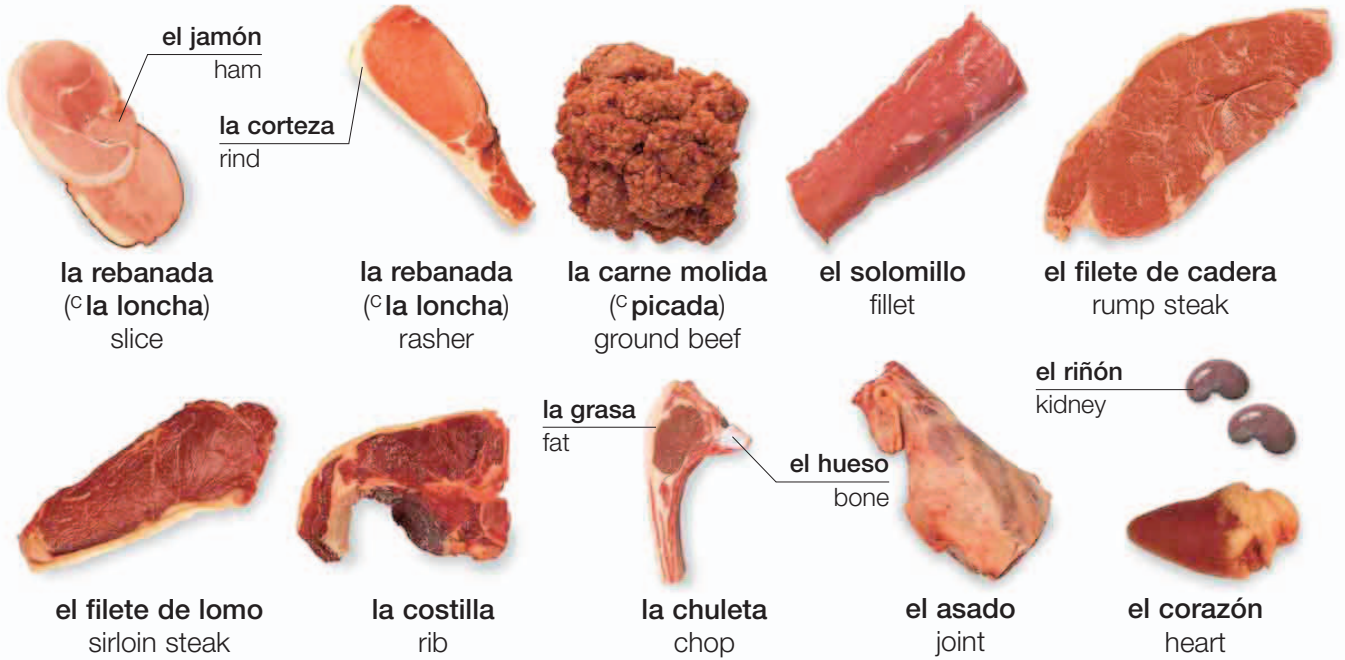

las aves • poultry

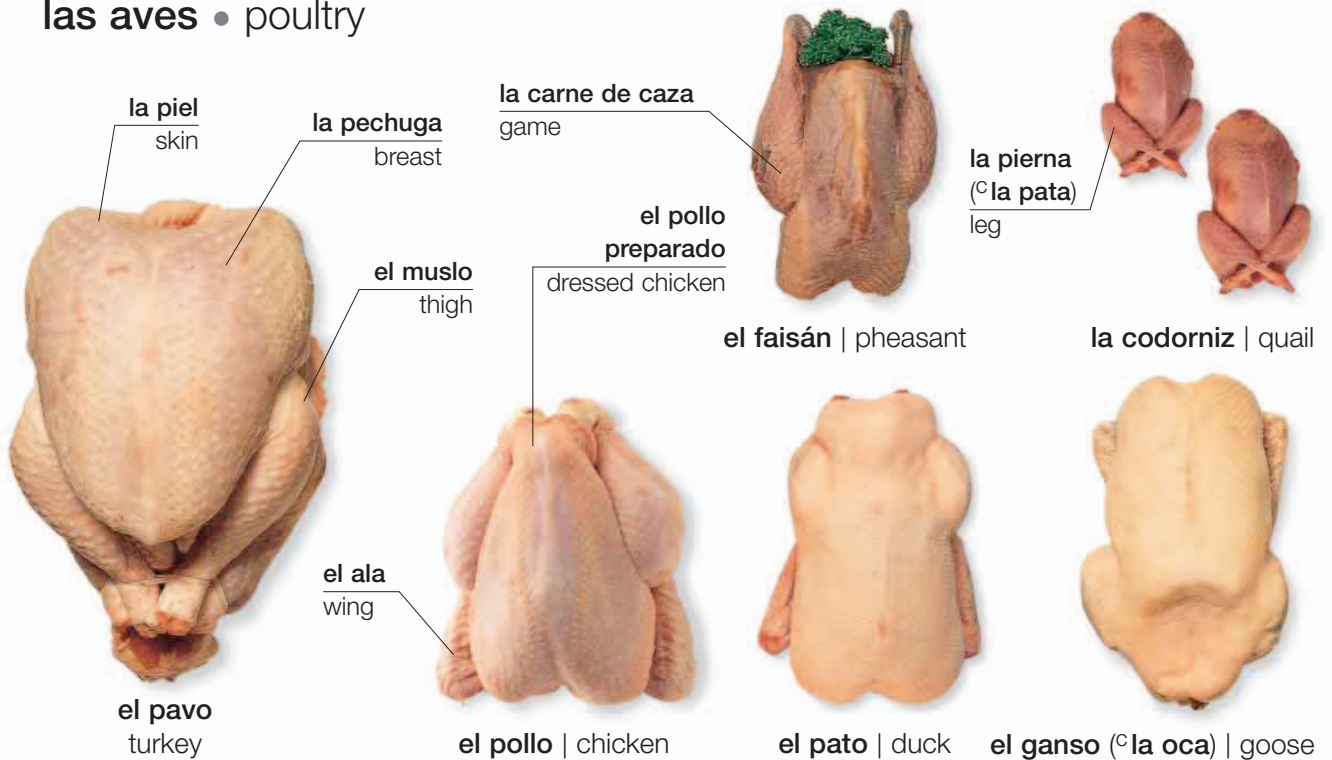

el pescado • fish

los camarones pelados
(^o las gambas peladas)
peeled shrimp

el hielo
ice

el salmonete
red mullet

los filetes
de mero
halibut fillets

la trucha arco iris
rainbow trout

las aletas de
raya
skate wings

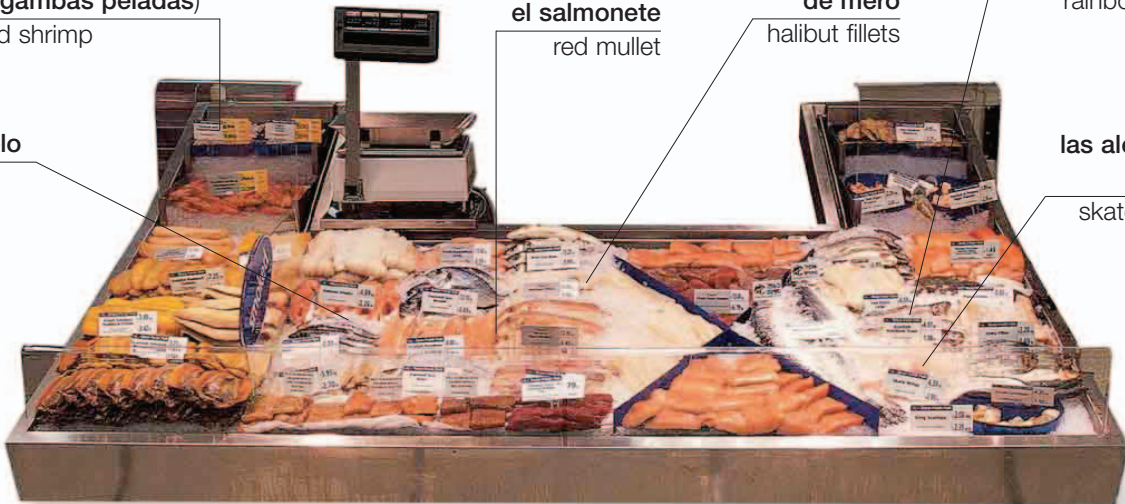

la pescadería
fish seller



el rape
monkfish



la caballa
mackerel



la trucha
trout



el pez espada
swordfish



el lenguado
Dover sole



la platija
lemon sole



el abadejo
haddock



la sardina
sardine



la raya
skate



la pescadilla
silver hake



la lubina
sea bass



el salmón | salmon



el bacalao
cod



el besugo
sea bream



el atún
tuna

el marisco • seafood

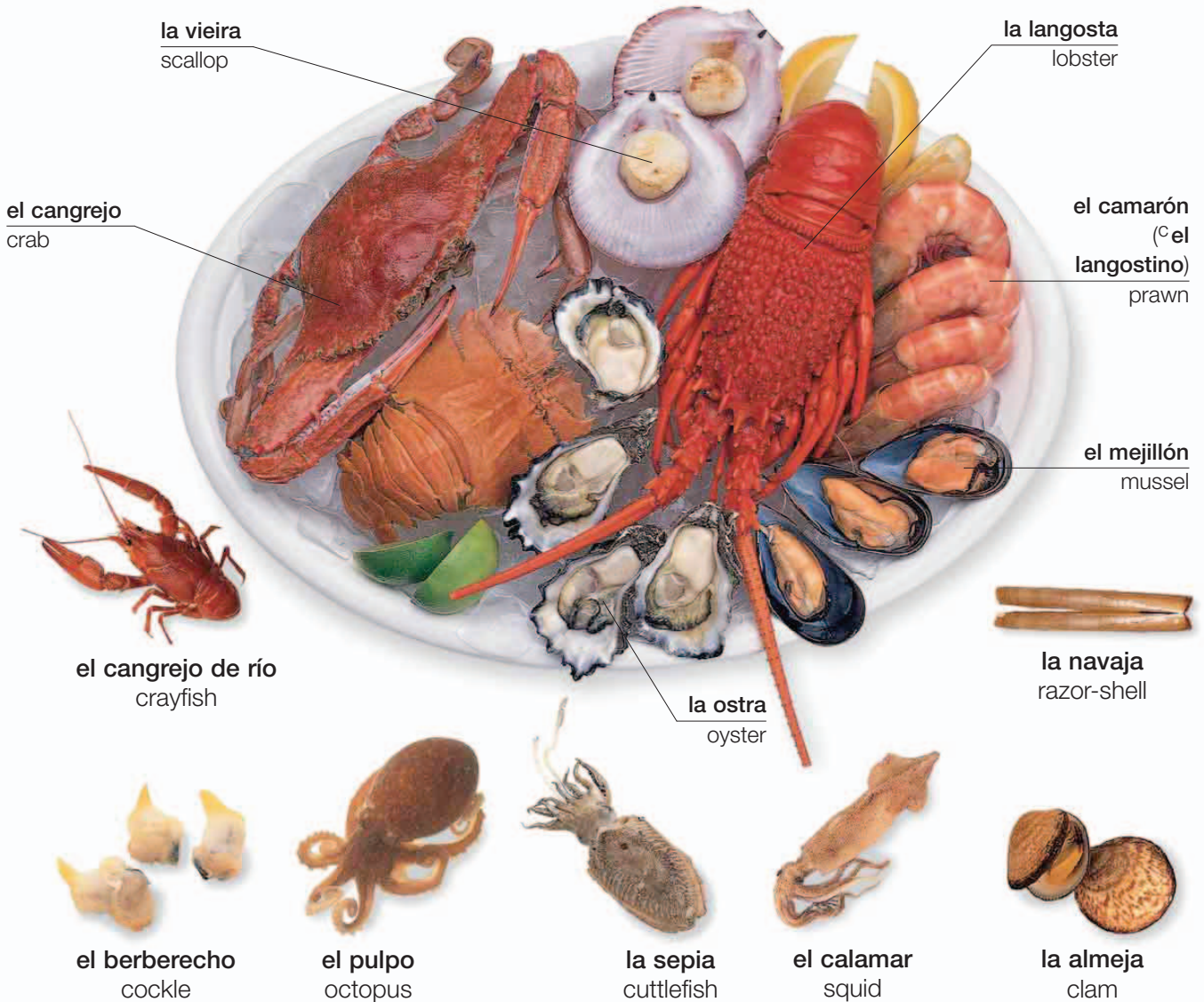

vocabulario • vocabulary

congelado limpio ahumado sin escamas en filetes la rodaja la cola la espina la escama
frozen cleaned smoked descaled filleted steak tail bone scale

fresco salado sin piel sin espinas el filete el lomo ¿Me lo puede limpiar?
fresh salted skinned boned fillet loin Can you clean it for me?

las verduras 1 • vegetables 1



la haba
fava bean

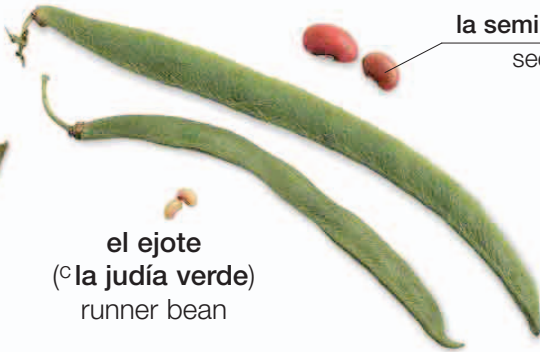

el ejote
(^o la judía verde)
runner bean

la semilla
seed



el ejote
(^o la judía verde)
green bean



el chicharo
(^o el guisante)
pea



el maíz dulce
corn



el germinado de soja
bean sprout



el bambú
bamboo

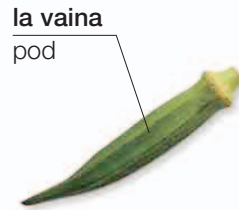

la vaina
pod

el quingombó
okra



el apio
celery



la endibia
chicory



el hinojo
fennel



los palmitos
palm hearts

vocabulario • vocabulary

la hoja
leaf

la cabezuela
floret

la punta
tip

biológico
organic

el tallo
stalk

la almendra
kernel

el corazón
(^o el centro)
heart

la bolsa de plástico
plastic bag

¿Vende verduras orgánicas
(^o biológicas)?

Do you sell organic
vegetables?

¿Son productos locales?

Are these grown locally?



la roqueta
arugula



el berro
watercress



el radicchio
radicchio



la col de bruselas
Brussels sprout



la acelga
swiss chard



la col rizada
kale



la acedera
sorrel



la escarola
endive



el diente de león
dandelion



la espinaca
spinach



el colinabo
kohlrabi



la acelga china
bok choy



la lechuga
lettuce



el brócoli
broccoli



la col
cabbage



la berza
young cabbage

las verduras 2 • vegetables 2

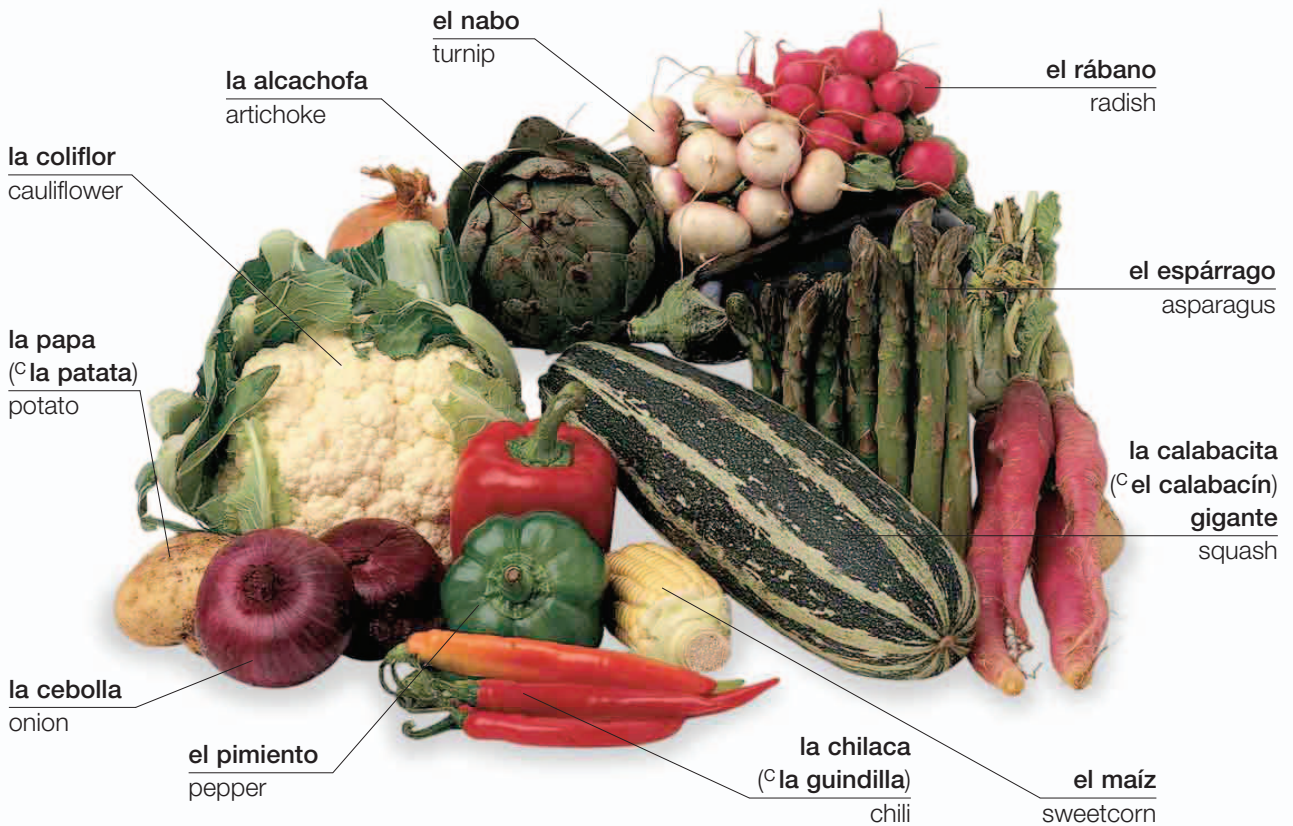

vocabulario • vocabulary

la mandioca
cassava

el apio-nabo
celeriac

congelado
frozen

amargo
bitter

¿Me da un kilo de papas
(^opatatas), por favor?
May I have one kilo of
potatoes please?

la zanahoria
carrot

la raíz del taro
taro root

crudo
raw

firme
firm

¿Cuánto vale el kilo?
What's the price per kilo?

el fruto del pan
breadfruit

la castaña de agua
water chestnut

picante
hot (spicy)

la pulpa
pulp

¿Cómo se llaman?
What are those called?

la papa (^ola
patata) nueva
new potato

el jitomate (^oel
tomate) cherry
cherry tomato

dulce
sweet

la raíz
root



el camote
(^cel boniato)
sweet potato



el ñame
yam



el betabel
(^cla remolacha)
beet



la rapa svedese
(^cel nabo sueco)
rutabaga



el topinambur
Jerusalem
artichoke



el rábano picante
horseradish



la chirivía
parsnip



el jengibre
ginger



la berenjena
eggplant



el jitomate
(^cel tomate)
tomato



el cebollín
(^cla cebolleta)
scallion

el puerro
leek



el chalote
shallot



el ajo
garlic

el diente
clove



el champiñón
mushroom

la trufa
truffle



el pepino
cucumber

la calabacita
(^cel calabacín)
zucchini



la calabaza
butternut squash



la calabaza bellota
acorn squash



la calabaza
pumpkin

la fruta 1 • fruit 1

los cítricos • citrus fruit



la naranja
orange



la mandarina clementina
clementine



el ugli
tangelo

la piel (°la
médula)
pulp

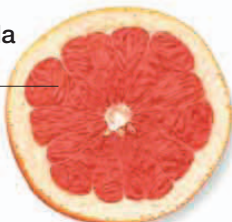

la toronja (°el pomelo)
grapefruit



la mandarina
tangerine

el gajo
segment



la mandarina satsuma
satsuma



la lima
lime

la cáscara
(°la corteza)
zest



el limón
lemon



la naranja china (°el kumquat)
kumquat

la fruta con hueso • stone fruit



el durazno
(°el melocotón)
peach



la nectarina
nectarine



el chabacano
(°el albaricque)
apricot



la ciruela
plum



la cereza
cherry

la pera
pear

la manzana
apple



el frutero (°la cesta de fruta) | basket of fruit

las bayas y los melones • berries and melons



la fresa
strawberry



la frambuesa
raspberry



el melón
melon



la uva
grapes



la zarzamora (c la mora)
blackberry



la grosella
redcurrant

la cáscara
(c la corteza)
rind



la grosella negra
blackcurrant

la semilla
(c la pepita)
seed



el arándano rojo
cranberry

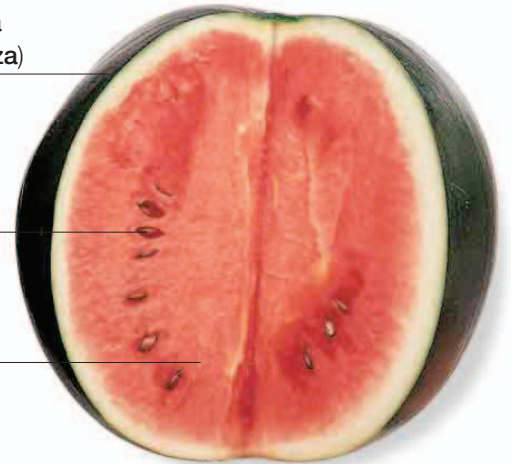

la pulpa
flesh

la sandía
watermelon



el arándano
blueberry



la grosella blanca
white currant



la frambuesa Logan
loganberry

vocabulario • vocabulary

el ruibarbo
rhubarb

amargo
sour

fresco
crisp

el corazón
core

¿Están maduros?
Are they ripe?

la fibra
fiber

fresco
fresh

podrido
rotten

la pulpa
pulp

¿Puedo probar uno?
May I try one?

dulce
sweet

jugoso
juicy

el jugo
(c el zumo)
juice

sin
semillas
(c pepitas)
seedless

¿Hasta cuándo
durarán?
How long will they
keep?



el capulín
(c la grosella espinosa)
gooseberry

la fruta 2 • fruit 2

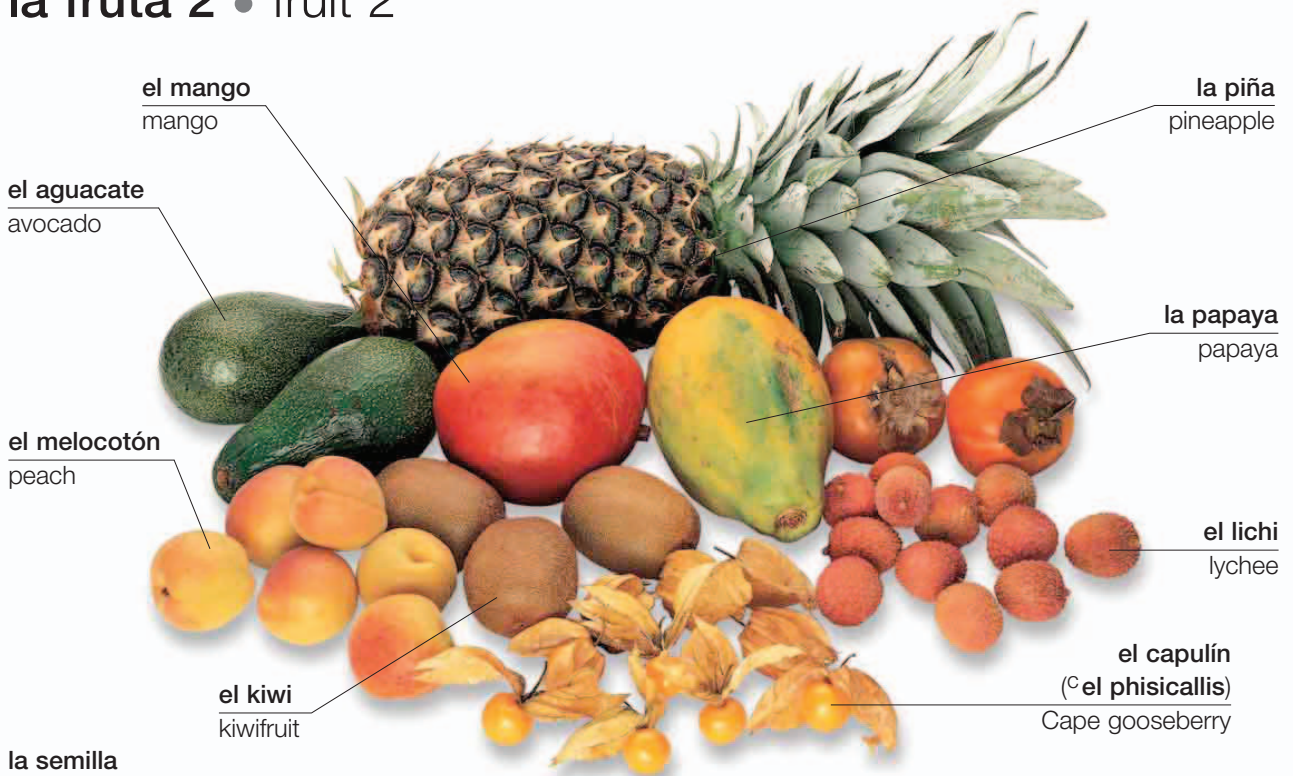

la semilla
pit

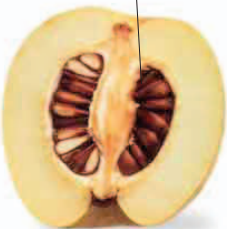

el membrillo
quince



el maracuyá
passion fruit

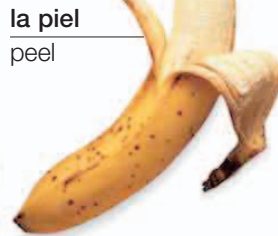

el plátano
banana



la guayaba
guava



la granada
pomegranate



el caqui
persimmon



la feijoa
feijoa



la tuna
([©]el higo chumbo)
prickly pear



la carambola
star fruit



el tomate de árbol
tamarillo

los frutos seco • nuts and dried fruit



el piñón
pine nut



el pistache
(^cel pistacho)
pistachio



la nuez de la India
(^cel anacardo)
cashew nut



el cacahuete
peanut



la avellana
hazelnut



la nuez de Brasil
Brazil nut



la nuez
(^cla pacana)
pecan



la almendra
almond



la nuez de Castilla
(^cla nuez) | walnut



la castaña
chestnut



la macadamia
macadamia



el higo
fig



el dátil
date



la ciruela pasa
prune

la cáscara
shell



la pasa sultana
sultana



la pasa
raisin



la pasa de Corinto
currant

la pulpa
flesh

el coco
coconut



vocabulario • vocabulary

verde
green

duro
hard

la almendra
kernel

salado
salted

tostado
roasted

las frutas tropicales
tropical fruit

pelado
shelled

maduro
ripe

blando
soft

desechado
dried

crudo
raw

de temporada
seasonal

la fruta escarchada
candied fruit

entero
whole

los granos y las legumbres • grains and pulses

los granos • grains



el trigo
wheat



la avena
oats



la cebada
barley



el mijo
millet



el maíz
corn

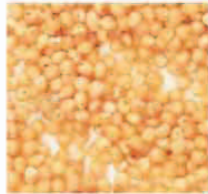

la quinoa
quinoa

vocabulario • vocabulary

la semilla
seed

fresco
fresh

integral
whole-
grain

la cáscara
husk

perfumado
fragranced

largo
long-grain

el grano
kernel

los cereales
cereal

corto
short-grain

seco
dry

**poner a
remojo**
soak (v)

**de fácil
coCCIÓN**
easy-to-
cook

el arroz • rice



el arroz largo
white rice



el arroz integral
brown rice



el arroz salvaje
wild rice



el arroz bomba
dessert rice

los granos procesados • processed grains



el cuscús
couscous



el trigo partido
cracked wheat



la sémola
semolina



el salvado
bran

los frijoles y los chícharos (las alubias y los guisantes) • beans and peas



el frijol blanco
(^ola alubia blanca)
lima beans



el frijol blanco chico
navy beans



el frijol rojo
(^ola alubia roja)
kidney beans



el frijol morado
(^ola alubia morada)
aduki beans



las habas
fava beans



la semilla de soja
soybeans



el frijol (^ola alubia) de ojo negro
black-eyed peas



el frijol pinto
(^ola alubia pinta)
pinto beans



el frijol mung
(^ola alubia mung)
mung beans



el frijol flageolet
(^ola alubia flageolet)
flageolet beans



la lenteja castellana
brown lentils



la lenteja roja
red lentils



los chícharos
(^olos guisantes tiernos)
peas



los garbanzos
chick peas



los chícharos secos
(^olos guisantes secos)
split peas

las semillas • seeds



la pepita (^ola pipa) de calabaza
pumpkin seed



la semilla de mostaza (^ola mostaza en grano)
mustard seed



el carvi
caraway



la semilla de sésamo
sesame seed



la semilla de girasol
sunflower seed

las hierbas y las especias • herbs and spices

las especias • spices



la vainilla
vanilla



la nuez moscada
nutmeg



la macis
mace



la cúrcuma
turmeric



el comino
cumin



el ramillete
aromático
bouquet garni



la pimienta de
Jamaica
allspice

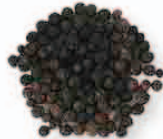

la pimienta en
grano
peppercorn



el heno griego
fenugreek



el chile piquín
(^o la guindilla)
chilli

entero
whole

machacado
crushed

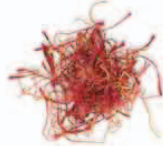

el azafrán
saffron



el cardamono
cardamom



el curry en polvo
curry powder



molido
ground



el pimentón
paprika

a hojuelas
(^o laminado)
flakes



el ajo
garlic

las hierbas • herbs

las rajas
(C las ramas)
sticks



la canela
cinnamon



la citronela
lemon grass



los clavos
cloves



el anís
estrellado
star anise



el jengibre
ginger

las semillas
de hinojo
fennel seeds



el hinojo
fennel



los cebollinos
chives



la menta
mint



el laurel
bay leaf



el perejil
parsley



el tomillo
thyme



la salvia
sage



el estragón
tarragon



la mejorana
marjoram



la albahaca
basil



el orégano
oregano



el cilantro
coriander



el eneldo
dill



el romero
rosemary

los alimentos embotellados • bottled foods

el aceite de nueces
walnut oil

el aceite de
almendras
almond oil

el aceite de
semillas de uva
grapeseed oil

el corcho
cork

el aceite de
girasol
sunflower oil



el aceite de sésamo
sesame seed oil

el aceite de avellanas
hazelnut oil

el aceite de oliva
olive oil

las hierbas
herbs

el aceite
aromatizado
flavored oil

los aceites
oils

las conservas dulces • sweet spreads

el tarro
jar

el panal
honeycomb

la miel
cristalizada
(^o compacta)
set honey



la crema de
limón
lemon curd

la mermelada de
frambuesa
raspberry jam

la mermelada de
naranja
marmalade

la miel líquida
clear honey

la miel de maple
(^o el jarabe de arce)
maple syrup

los condimentos • condiments and spreads



vocabulario • vocabulary

el aceite vegetal vegetable oil	el aceite de colza canola oil
el aceite de maíz corn oil	el aceite de presión en frío cold-pressed oil
el aceite de cacahuete peanut oil	

los productos lácteos • dairy products

el queso • cheese

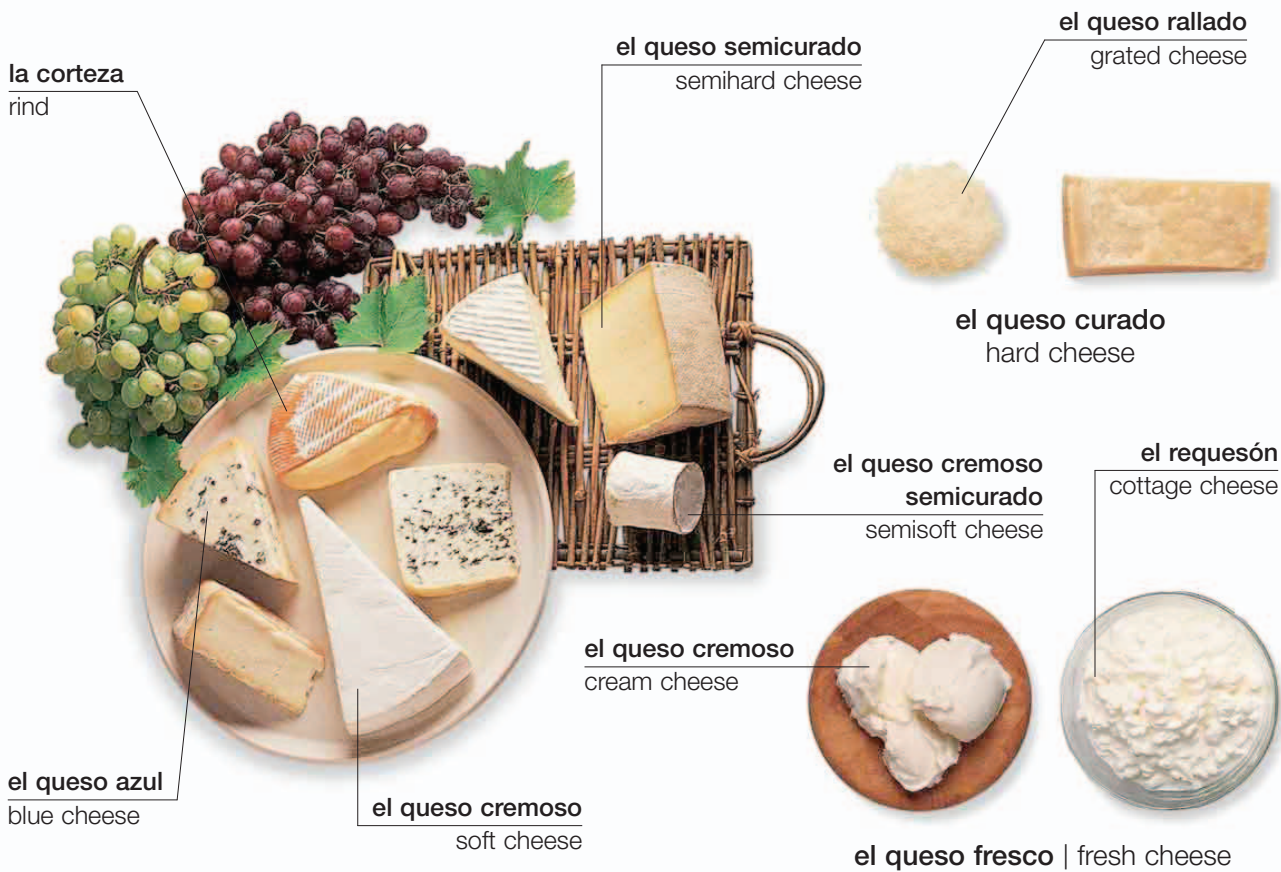

la leche • milk





la mantequilla
butter



la margarina
margarine



la crema (°la nata)
cream



la crema (°la nata) líquida
half-and-half cream



la crema para batir
(°la nata para montar)
whipping cream



la crema batida
(°la nata montada)
whipped cream



la crema ácida
(°la nata agria)
sour cream



el yogurt
yogurt



el helado
ice cream

los huevos • eggs

la yema
yolk

la clara
egg white

la cáscara
shell



la huevera
eggcup

el huevo tibio (°pasado por agua)
soft-boiled egg



el huevo de ganso
(°de oca)
goose egg



el huevo de gallina
hen's egg



el huevo de pato
duck egg



el huevo de codorniz
quail egg

vocabulario • vocabulary

pasteurizado
pasteurized

sin grasa
fat-free

salado
salted

la leche de oveja
sheep's milk

homogeneizado
homogenized

la lactosa
lactose

sin pasteurizar
unpasteurized

la leche en polvo
powdered milk

sin sal
unsalted

el suero de la leche
buttermilk

la malteada
(°el batido)
milkshake

el yogurt helado
frozen yogurt

el pan y las harinas • breads and flours

el pan de caja
(^cde molde)
sliced bread

las semillas de
amapola
poppy seeds

el pan de centeno
rye bread

la baguette
French bread



la panadería | bakery

haciendo pan • making bread



la harina blanca
white flour



la harina morena
whole-wheat flour



la harina integral
stone-ground flour



la levadura
yeast



cernir (^ccribar) | sift (v)



mezclar | mix (v)

la masa
dough



amasar | knead (v)



hornear | bake (v)



la corteza
crust

el pan blanco
white bread



la hogaza
loaf

el pan negro (°moreno)
brown bread



el pan integral
whole-wheat bread

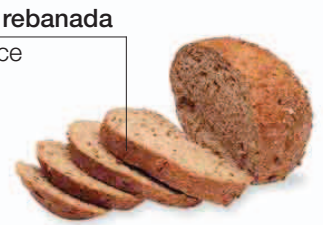

la rebanada
slice

el pan con grano
multigrain bread



el pan de maíz
corn bread



el pan al bicarbonato
sódico
soda bread



el pan fermentado
sourdough bread



el pan sin levadura
flat bread



la dona (°la rosquilla)
bagel



el bollo
bun



el panecillo
roll



el pan de frutas
(°el plumcake)
fruit bread



el pan con semillas
seeded bread



el naan
naan bread



la pita
pita bread

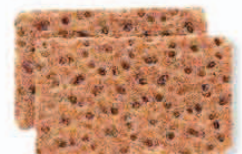

el pan danés (°el biscote)
crispbread

vocabulario • vocabulary

la harina con levadura
self-rising flour

la harina blanca
all-purpose flour

levar
prove (v)

la barra
flute

el rebanador
slicer

la harina para pan
bread flour

subir
rise (v)

glasear
glaze (v)

el pan molido
(°rallado)
breadcrumbs

el panadero
baker

la repostería • cakes and desserts



el profiterol
éclair

la masa de profiteroles
profiterole pastry

la crema
(^o **la nata**)
cream

el hojaldre
puff pastry

el relleno
filling

la masa brisa
filo dough

el plum-cake
fruit cake

cubierto de chocolate
chocolate coated

la tartaleta de fruta
fruit pie

el muffin
muffin

el merengue
meringue

la magdalena
sponge cake

los pasteles | cakes

vocabulario • vocabulary

la crema pastelera
pastry cream

el bollo
bun

la masa
pastry

la celebración
celebration

¿Puedo tomar una rebanada (^o un trozo)?

el pastel de chocolate
chocolate cake

las natillas
custard

la rebanada
(^o **el trozo**)
slice

el arroz con leche
rice pudding

May I have a slice please?

los chips (los trocitos)
de chocolate
chocolate chip



las soletillas
lady fingers



la florentina
florentine

el postre de
soletillas, gelatina
de frutas y crema
trifle

las galletas | cookies



el mousse
mousse



el sorbete
sorbet



el pastel de crema (nata)
custard pie



el flan
crème caramel

los pasteles para celebraciones • special occasion cakes

el último piso
top tier

el listón
(la cinta)
ribbon

la decoración
decoration

las velas de
cumpleaños
birthday candles

apagar
blow out (v)

el primer piso
bottom tier

la alcorza
icing

el mazapán
marzipan



el pastel de bodas (la tarta nupcial)
wedding cake



el pastel (la tarta) de cumpleaños | birthday cake

la charcutería • delicatessen

el fiambre
spicy sausage

el aceite
oil



el vinagre
vinegar

la carne fresca
uncooked meat

el mostrador
counter

la quiche
quiche



el salami
salami

el salchichón
pepperoni

el paté
pâté



la mozzarella
mozzarella



el brie
Brie



el queso de cabra
goat's cheese



el cheddar
Cheddar



el parmesano
Parmesan



el camembert
Camembert

la corteza
rind



el queso de bola
Edam



el manchego
Manchego

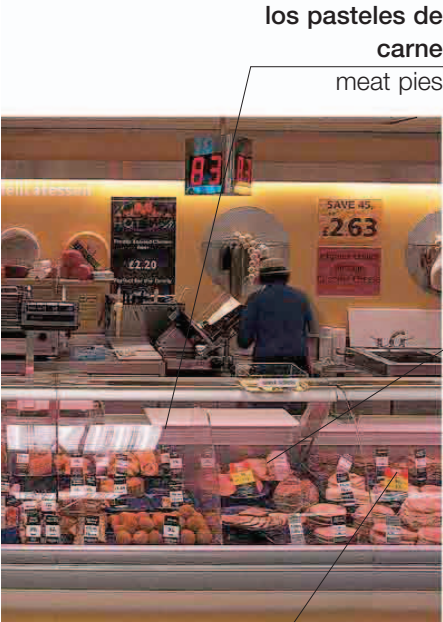

los pasteles de carne
meat pies

el jamón
ham



la aceituna negra
black olive

el panecillo
roll

el fiambre
cooked meat

la aceituna verde
green olive

el chile piquín
(^o la guindilla)
chili

la salsa
sauce

el mostrador de bocadillos
sandwich counter



el pescado ahumado
smoked fish



las alcaparras
capers



el jamón serrano
prosciutto

el chorizo
chorizo



la aceituna rellena
stuffed olive

vocabulario • vocabulary

en aceite
in oil

salado
salted

ahumado
smoked

en salmuera
in brine

marinado
(^o adobado)
marinated

curado
cured

Tome un número, por favor.

Take a number, please.

¿Puedo probar un poco de eso?

Can I try some of that, please?

¿Me pone seis rebanadas (^o lonchas) de aquél?

May I have six slices of that, please?

las bebidas • drinks

el agua • water

el agua embotellada
bottled water



el agua mineral
mineral water

con gas
sparkling



sin gas
noncarbonated



el agua de la llave
(^cdel grifo)
tap water



la tónica
tonic water



la soda
soda water

las bebidas calientes • hot drinks

la bolsita de té
teabag



el té en hoja
loose leaf tea



el té
tea

los granos
beans



el café molido
ground coffee



el café
coffee



el chocolate
caliente
hot chocolate



la bebida
malteada
malted drink

los refrescos • soft drinks

el popote
(^cla pajita)
straw



el jugo (^cel zumo)
de tomate
tomato juice



el jugo (^cel zumo)
de uva
grape juice



la limonada
lemonade



la naranjada
orangeade



la cola
cola



las bebidas alcohólicas • alcoholic drinks



la ginebra
gin



la cerveza
beer

la lata
can



la sidra
hard cider



la cerveza
amarga
bitter



la cerveza negra
stout



el vodka
vodka



el whisky
whiskey



el ron
rum



el brandy (° el coñac)
brandy



el oporto
port



el vino de jerez
sherry

seco
dry



el campari
campari

rosado
rosé

blanco
white

tinto
red



el licor
liqueur



el tequila
tequila



el champán
champagne



el vino
wine



el vino
wine





comer fuera
eating out

la cafetería • café



la carta
menu

el toldo
awning

la cafetería con mesas fuera | sidewalk café



la sombrilla
umbrella

la terraza
terrace café

el mesero
(^cel camarero)
server

la máquina del café
coffee machine

la mesa
table



el bar | snack bar

el café • coffee

el café con leche
coffee with cream

el café solo
black coffee

la cocoa (^cel cacao en polvo)
cocoa powder

la espuma
froth



el café de cafetera eléctrica
filter coffee

el expreso (^cel café solo)
espresso

el cappuccino
cappuccino

el café con hielo
iced coffee

el té • tea

el té de hierbas
([©]la infusión)
herbal tea



la manzanilla
camomile tea



el té verde
green tea



el té con leche
tea with milk

el té sólo
black tea



el té con limón
tea with lemon



la menta poleo
mint tea



el té con hielo
iced tea

los jugos y las malteadas ([©] los zumos y los batidos) • juices and milkshakes



el jugo de
naranja
orange juice



el jugo de
manzana
apple juice



el jugo de
piña
pineapple juice



el jugo de
tomate
tomato juice

la malteada de chocolate
chocolate milkshake

la
malteada
de fresa
strawberry
milkshake

la malteada
de café
coffee
milkshake



la comida • food

el pan integral
brown bread



el sandwich tostado
toasted sandwich



la ensalada
salad



el helado
ice cream

la bola
scoop



el pan dulce ([©] el pastel)
pastry

el bar • bar



el medidor óptico
dispenser

la caja
cash register

el barman
([©] el camarero)
bartender

**la llave ([©] el grifo)
de cerveza**
beer tap

**la cafetera ([©] la
máquina del café)**
coffee machine

las copas ([©] los vasos)
glasses

la champanera
ice bucket

la silla
([©] el taburete)
bar stool

el cenicero
ashtray

el posavasos
coaster

la barra
bar

el destapador
([©] el abrebotellas)
bottle opener



el sacacorchos | corkscrew

la palanca
lever

las pinzas
tongs



la coctelera | cocktail shaker

el agitador
stirrer

el medidor
measure



el gin tonic
gin and tonic

la jarra
pitcher



el whiskey escocés con agua
scotch and water



el cubito de hielo
ice cube

la cuba libre
(^cel ron con cola)
rum and coke



el desarmador
(^cel vodka con naranja)
vodka and orange



el martini
martini



el cóctel
cocktail



el vino
wine



la cerveza | beer



un trago
a shot

sencillo
single



la medida
measure

doble
double



sin hielo
without ice

con hielo y limón
ice and lemon



con hielo
with ice



la botana (^clos aperitivos) • bar snacks



las papas (^clas patatas) fritas
potato chips

las nueces de la India
(^clos anacardos)
cashews

las almendras
almonds



los frutos secos | nuts

los cacahuets
peanuts



las aceitunas | olives

el restaurante • restaurant

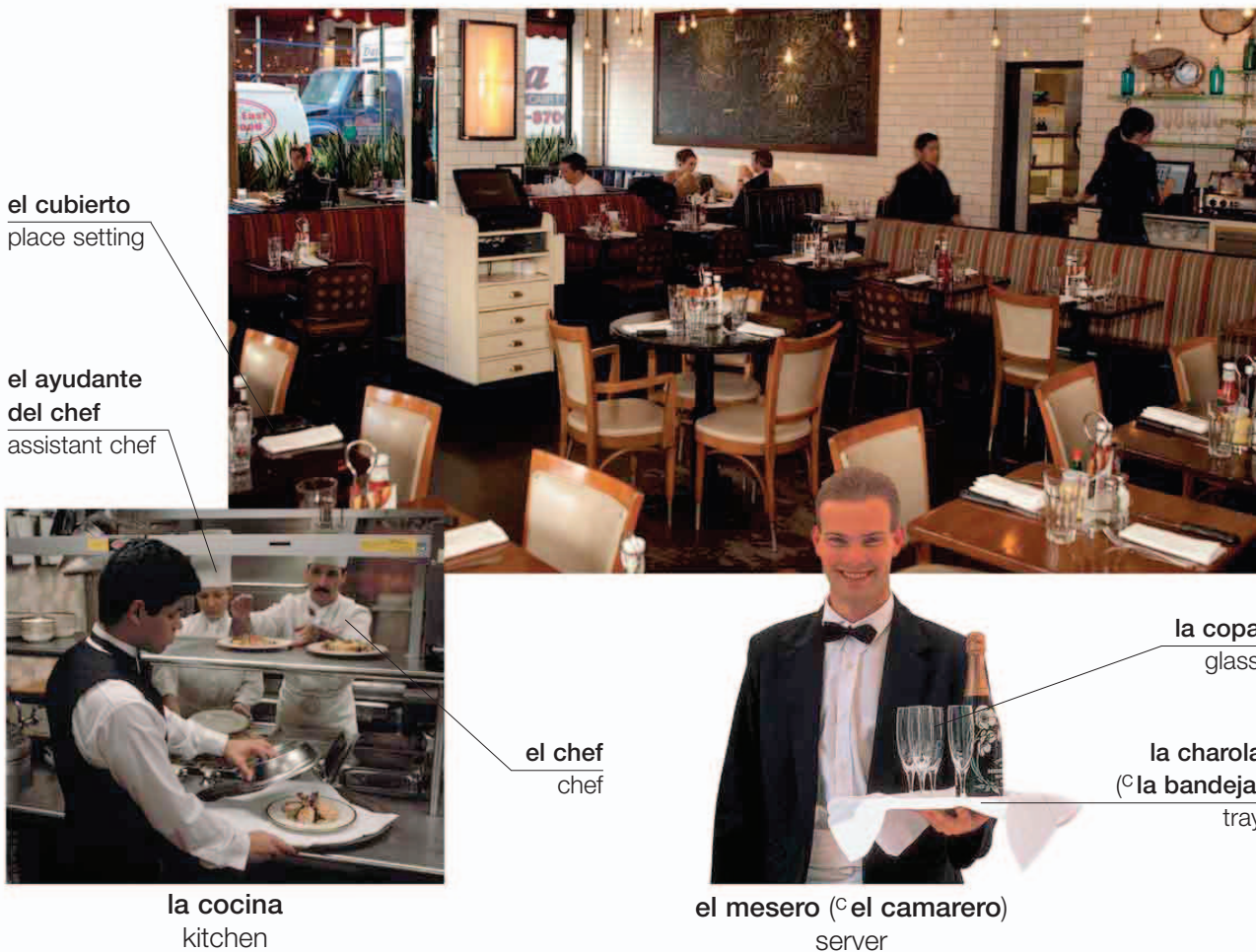

el cubierto
place setting

el ayudante del chef
assistant chef

el chef
chef

la cocina
kitchen

la copa
glass

la charola
(^ola bandeja)
tray

el mesero (^oel camarero)
server

vocabulario • vocabulary

la lista de vinos
wine list

a la carta
à la carte

el precio
price

la propina
tip

el buffet
buffet

el cliente
customer

el menú de la comida
lunch menu

el carrito de los postres
dessert cart

la cuenta
check

servicio incluido
service charge included

el bar
bar

la pimienta
pepper

el menú de la cena
dinner menu

los platillos
(^olos platos)
del día
specials

el recibo
receipt

servicio no incluido
service charge not included

la sal
la sal



la carta
menu



el menú para niños
child's meal



ordenar (c pedir)
order (v)



pagar
pay (v)

los platos • courses



el aperitivo
apéritif



la entrada
(c el entrante)
appetizer



la sopa
soup



el plato principal
main course



el acompañamiento
side order



el postre | dessert



el café | coffee

Una mesa para dos, por favor.
A table for two, please.

¿Podría ver la carta/lista de vinos, por favor?

Can I see the menu/wine list, please?

¿Hay menú del día?

Is there a prix fixe menu?

¿Tiene platos vegetarianos?

Do you have any vegetarian dishes?

¿Me podría traer la cuenta/un recibo?

Could I have the check/a receipt, please?

¿Podemos pagar por separado?

Can we pay separately?

¿Dónde están los baños (c los servicios), por favor?

Where are the rest rooms, please?

la comida rápida • fast food



la hamburguesa
burger

el popote (c la pajita)
straw

el refresco
soft drink

las papas fritas
(c las patatas fritas)
French fries

la servilleta de papel
paper napkin

la charola
(c la bandeja)
tray

la hamburguesa con papas fritas
burger meal

la pizza
pizza

la lista de precios
price list

el refresco en lata
(c la lata de bebida)
canned drink



la entrega a domicilio
delivery



el puesto
hot-dog stand

vocabulario •
vocabulary

la pizzería
pizzeria

el restaurant de hamburguesas
(c la hamburguesería)
fast food restaurant

el menú
menu

para comer en el local
eat in

para llevar
carry out

recalentar
reheat (v)

la catsup (c el ketchup)
ketchup

.....
¿Me lo pone para llevar?
Can I have that to go,
please?

¿Entregan a domicilio?
Do you deliver?



la hamburguesa
hamburger



la hamburguesa de pollo
chicken burger

el bollo
bun



la hamburguesa vegetariana
veggie burger

la mostaza
mustard

la salchicha
sausage

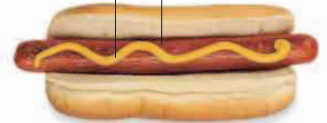

el hot dog (el perrito caliente) | hot dog



el bocadillo
sub



el club sandwich
club sandwich



el sandwich abierto
open-face sandwich

el relleno
filling



el taco
wrap



el alambre (el pincho moruno)
kabob

la salsa
sauce



los nuggets (las porciones) de pollo
chicken nuggets

salado
savory



la crêpe | crepes

dulce
sweet



los ingredientes
topping



el pescado con papas fritas
fish and chips



las costillas
ribs



el pollo frito
fried chicken



la pizza
pizza

el desayuno • breakfast



la leche
milk

los cereales
cereal

la mermelada
jam

la fruta seca
(^o desecada)
dried fruit

el jamón
ham

el queso
cheese

la galleta de centeno
crispbread

el buffet de desayuno
breakfast buffet

la mermelada de naranja
marmalade

el paté
pâté

la mantequilla
butter

el jugo (^o el zumo)
de frutas
fruit juice

el café
coffee



la mesa del desayuno | breakfast table

el chocolate caliente
(^o el cacao)
hot chocolate

el croissant
croissant



el té
tea

las bebidas | drinks



el pan dulce
brioche



el pan
bread

el pan tostado
toast

**el huevo
estrellado (C frito)**
fried egg

**el jitomate
(C el tomate)**
tomato

la morcilla
blood sausage

la salchicha
la salchicha

**el tocino
(C el bacon)**
bacon

el desayuno inglés
English breakfast



**los arenques
ahumados**
smoked herring



**el pan francés
(C la torrija)**
French toast

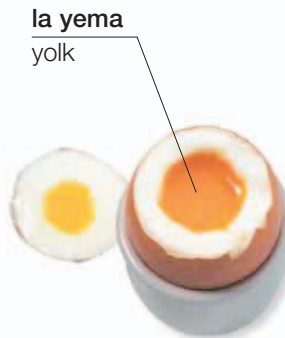

la yema
yolk

**el huevo tibio
(C pasado por agua)**
soft-boiled egg



los huevos revueltos
scrambled eggs

la crema (C la nata)
whipped cream

el yogurt de frutas
fruit yogurt



los crepes
pancakes

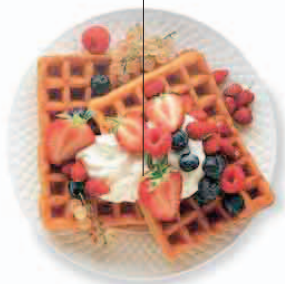

los waffles (C los gofres)
waffles



**la avena (C las
gachas de avena)**
oatmeal



la fruta fresca
fresh fruit

la comida principal • dinner



la sopa | soup



el caldo | broth



el guiso | stew



el curry | curried lamb



el asado
roast



la empanada (° el pastel)
pie



el soufflé
soufflé



la brocheta (° el pincho)
kabob



las albóndigas
meatballs



la omelette (° la tortilla)
omelette



el revuelto | stir fry

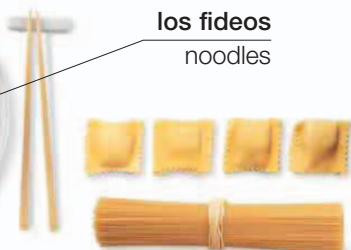

los fideos
noodles

la pasta | pasta



el arroz
rice



la ensalada mixta
tossed salad



la ensalada verde
green salad



el aderezo (° el aliño)
dressing

las técnicas • techniques



relleno | stuffed



en salsa | in sauce



a la plancha | grilled



adobado | marinated



escalfado | poached



hecho puré | mashed



al horno (° cocido en el horno) | baked



frito con poco aceite pan fried



frito fried



en vinagre pickled



ahumado smoked



frito con mucho aceite deep fried



en almíbar in syrup



sazonado (° aliñado) dressed



al vapor steamed



curado cured





el estudio
study

la escuela • school

el pizarrón (°la pizarra)
chalkboard

la maestra (°la profesora)
teacher



el salón | classroom

la mochila (°la cartera)
book bag

la alumna
pupil

el pupitre
desk

el gis (°la tiza)
chalk



la colegiala
schoolgirl

el colegial
schoolboy

vocabulario • vocabulary

la historia
history

el arte
art

la física
physics

la literatura
literature

la música
music

la química
chemistry

los idiomas
languages

la ciencia
science

la biología
biology

la geografía
geography

las matemáticas
math

la educación física
physical education

las actividades • activities



leer | read (v)



escribir | write (v)



deletrear
spell (v)



dibujar
draw (v)



el proyector digital
digital projector



la pluma
(^cel bolígrafo)
pen



el lápiz
pencil

el color
(^cel lápiz de colores)
colored pencil

el sacapuntas
pencil sharpener



la goma
eraser

el cuaderno
notebook



el libro de texto | textbook



el estuche
pencil case



la regla
ruler



preguntar
question (v)



contestar
answer (v)



discutir
discuss (v)



aprender
learn (v)

vocabulario • vocabulary

el director
principal

la respuesta
answer

el diccionario
dictionary

la lección
class

la redacción
essay

la enciclopedia
encyclopedia

la question
(^cla pregunta)
question

la tarea
(^clos deberes)
homework

la calificación
(^cla nota)
grade

tomar apuntes
take notes (v)

el examen
examination

el año
(^cel curso)
year

las matemáticas • math

las formas • shapes

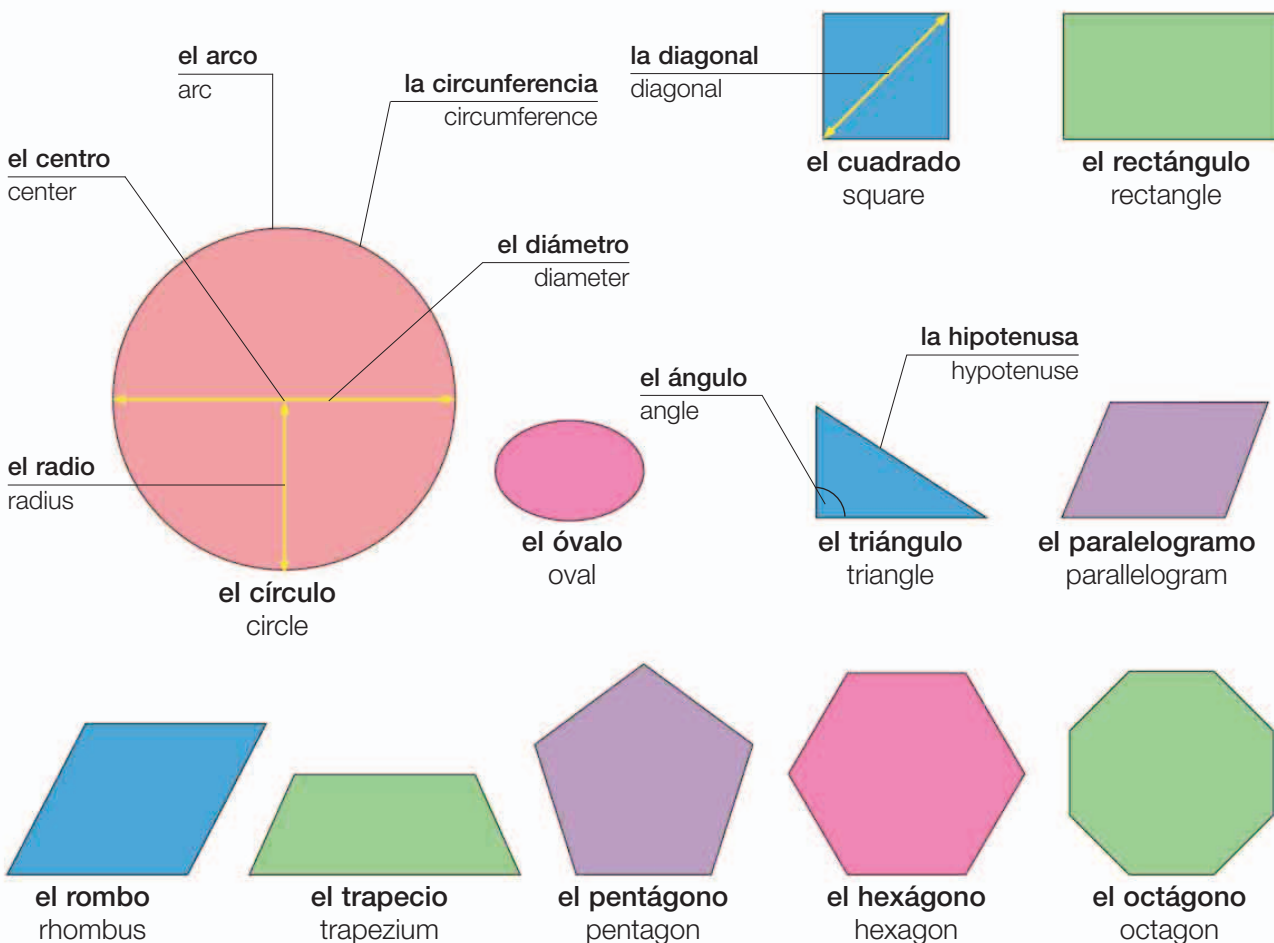

los cuerpos geométricos • solids

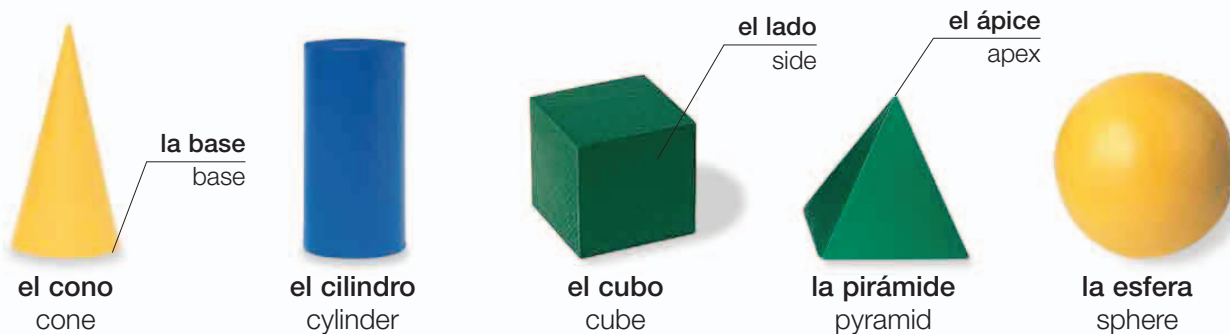

las líneas • lines



recto
straight

paralelo
parallel

perpendicular
perpendicular

curvo
curved

las medidas • measurements



el volumen
volume

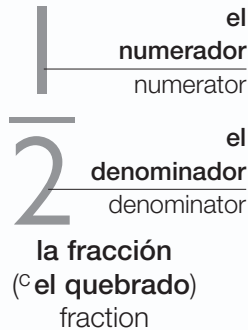

la fracción
(^o el quebrado)
fraction

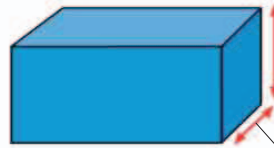

las dimensiones
dimensions

la anchura
width

la longitud
length

la altura
height

la profundidad
depth



el área
area

los materiales • equipment



la escuadra
set square



el transportador
protractor



la regla
ruler



el compás
compass



la calculadora
calculator

vocabulario • vocabulary

la geometría
geometry

más
plus

multiplicado por
times

igual a
equals

sumar
add (v)

multiplicar
multiply (v)

la ecuación
equation

la aritmética
arithmetic

menos
minus

dividido entre
(^o dividido por)
divided by

contar
count (v)

restar
subtract (v)

dividir
divide (v)

el porcentaje
percentage

las ciencias • science



el laboratorio
laboratory

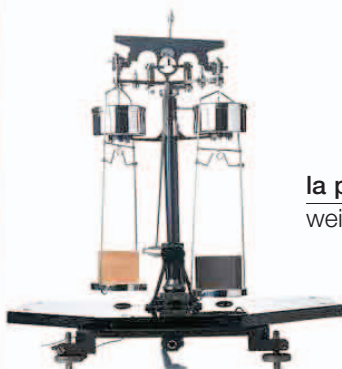

la báscula
scales



la pesa
weight

la balanza de muelle
spring balance

el crisol
crucible



el mechero
Bunsen
bunsen burner

el trípode
tripod



el frasco de
cristal
glass bottle

el embudo
funnel

el matraz
beaker

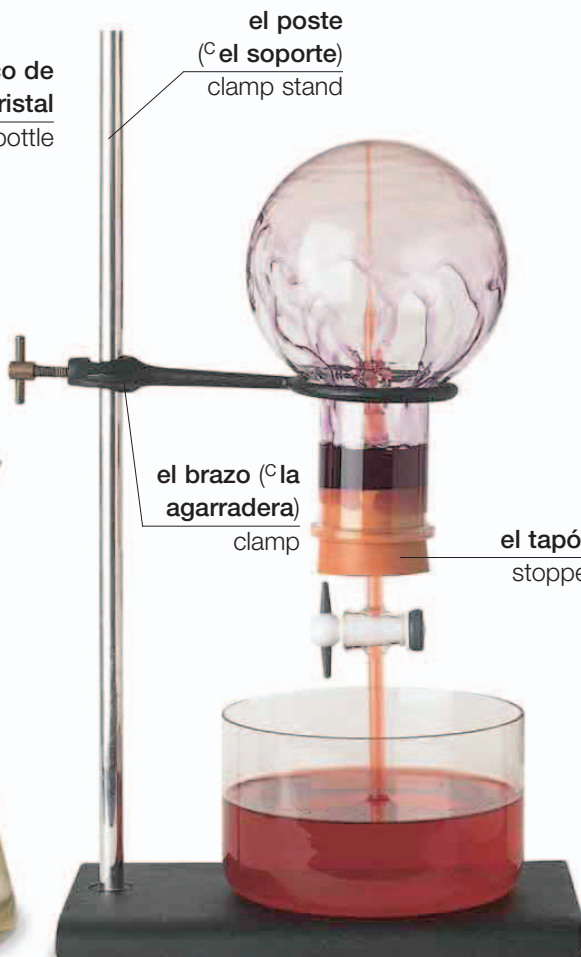

el poste
(^cel soporte)
clamp stand

el brazo (^cla
agarradera)
clamp

el tapón
stopper

el experimento | experiment

el tubo de
ensayo
test tube



el portatubos (^cel soporte)
rack



el cronómetro
timer



la cápsula de Petri
petri dish



el termómetro
thermometer



la jeringa
syringe



las pinzas
tweezers



el bisturí
scalpel



el gotero
(^cel cuentagotas)
dropper



los fórceps | forceps



las tenazas
tongs



la espátula
spatula

**la mano
de mortero**
pestle



el mortero
mortar



el filtro de papel
filter paper



las gafas protectoras
safety goggles

el ocular
eyepiece

la perilla
(^cel botón)
de ajuste
focusing knob



**la lente del
objetivo**
objective lens

la platina
stage

el portaobjetos
slide

el espejo
mirror

el microscopio | microscope

la varilla de cristal
glass rod



la pipeta
pipette



el vaso de precipitados
beaker



el imán
magnet



la pinza
alligator clip

el electrodo negativo
negative electrode



**el electrodo
positivo**
positive
electrode

la pila | battery

la enseñanza superior • college



la secretaria
admissions
office

el comedor
(^c el refectorio)
dining room

el centro de salud
health center

el campo
deportivo
playing field

la residencia
estudiantil
(^c el colegio
mayor)
residence hall

el campus | campus

la bibliotecaria
librarian



el mostrador de
préstamos
checkout desk

el librero (^c la
estantería)
bookshelf

el periódico
periodical

la revista
journal



la biblioteca | library

vocabulario • vocabulary

el préstamo
loan

la información
inquiries

renovar
renew (v)

reservar
reserve (v)

coger prestado
borrow (v)

el libro
book

la lista de
lecturas
reading list

la sala de
lecturas
reading room

el título
title

la fecha de
devolución
due date

la credencial
(^c la tarjeta de
la biblioteca)
library card

el pasillo
aisle

el estudiante
undergraduate

el profesor
professor



el auditorio (el anfiteatro)
lecture hall

la licenciada
graduate

la toga
gown



la ceremonia de graduación
graduation ceremony

las escuelas • schools



la modelo
model

la escuela de Bellas Artes
art school



el conservatorio
music school



la academia de danza
dance school

vocabulario • vocabulary

la beca
scholarship

la investigación
research

la tesina
dissertation

la medicina
medicine

la política
political science

el diploma
diploma

el doctorado
doctorate

el departamento
department

la zoología
zoology

la literatura
literature

la carrera
degree

la tesis
thesis

el derecho
law

la física
physics

la historia del arte
art history

posgrado
postgraduate

la maestría
(el máster)
master's degree

la ingeniería
engineering

la filosofía
philosophy

las ciencias
económicas
economics

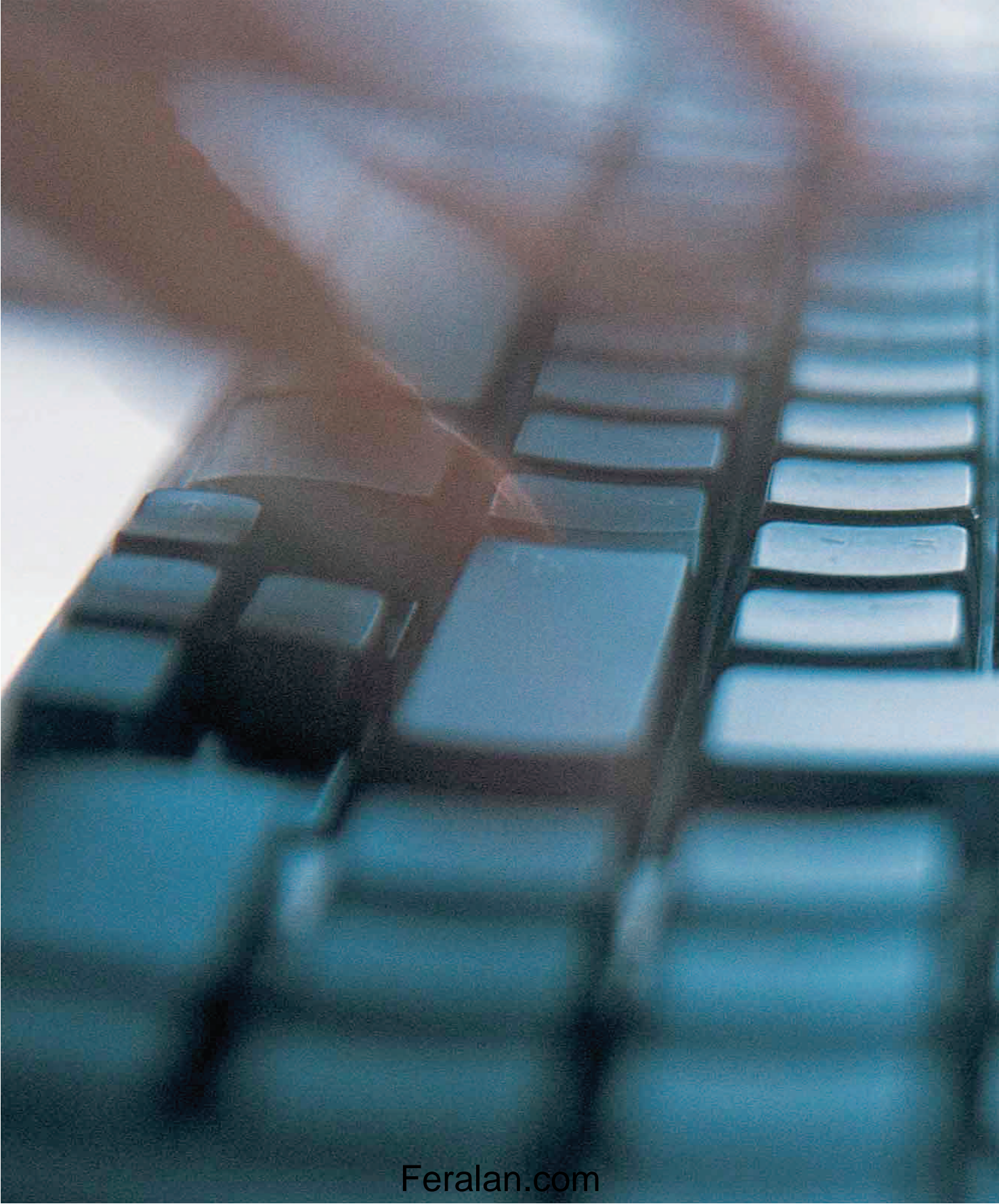



el trabajo
work

la oficina 1 • office 1



el equipo de oficina • office equipment



vocabulario • vocabulary

imprimir
print (v)

ampliar
enlarge (v)

fotocopiar
copy (v)

reducir
reduce (v)

Necesito sacar (^o hacer) unas copias.

I need to make some copies.

la papelería • office supplies

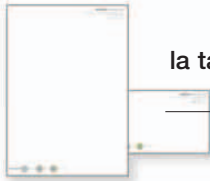

la tarjeta membretada (c la nota con saludos)
compliments slip

el membrete
letterhead



el sobre
envelope



la tabla con porta-papeles (c la tablilla con sujetapapeles)
clipboard



la libreta (c el bloc de apuntes)
notepad



el rótulo
tab

el colgante (c el archivador suspendido)
hanging file

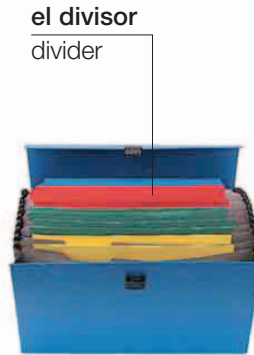

el divisor
divider

la carpeta de acordeón
accordion file



la caja archivador
box file

la carpeta de argollas (c de anillas)
binder file



la agenda
personal organizer

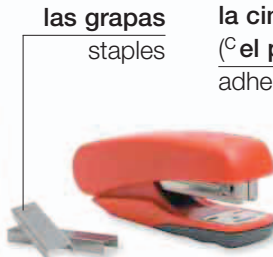

las grapas
staples

la engrapadora (c la grapadora)
stapler

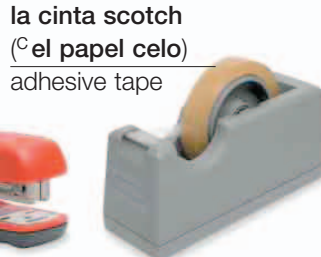

la cinta scotch (c el papel celo)
adhesive tape

el portacinta (c el soporte del papel celo)
tape dispenser



la perforadora
hole punch



el cojín de la tinta
ink pad

el sello
rubber stamp



la liga (c la goma elástica)
rubber band



la pinza (c el clip)
bulldog clip



el clip (c el sujetapapeles)
paper clip

la chinche (c la chincheta)
thumbtack



el corcho | bulletin board

la oficina 2 • office 2

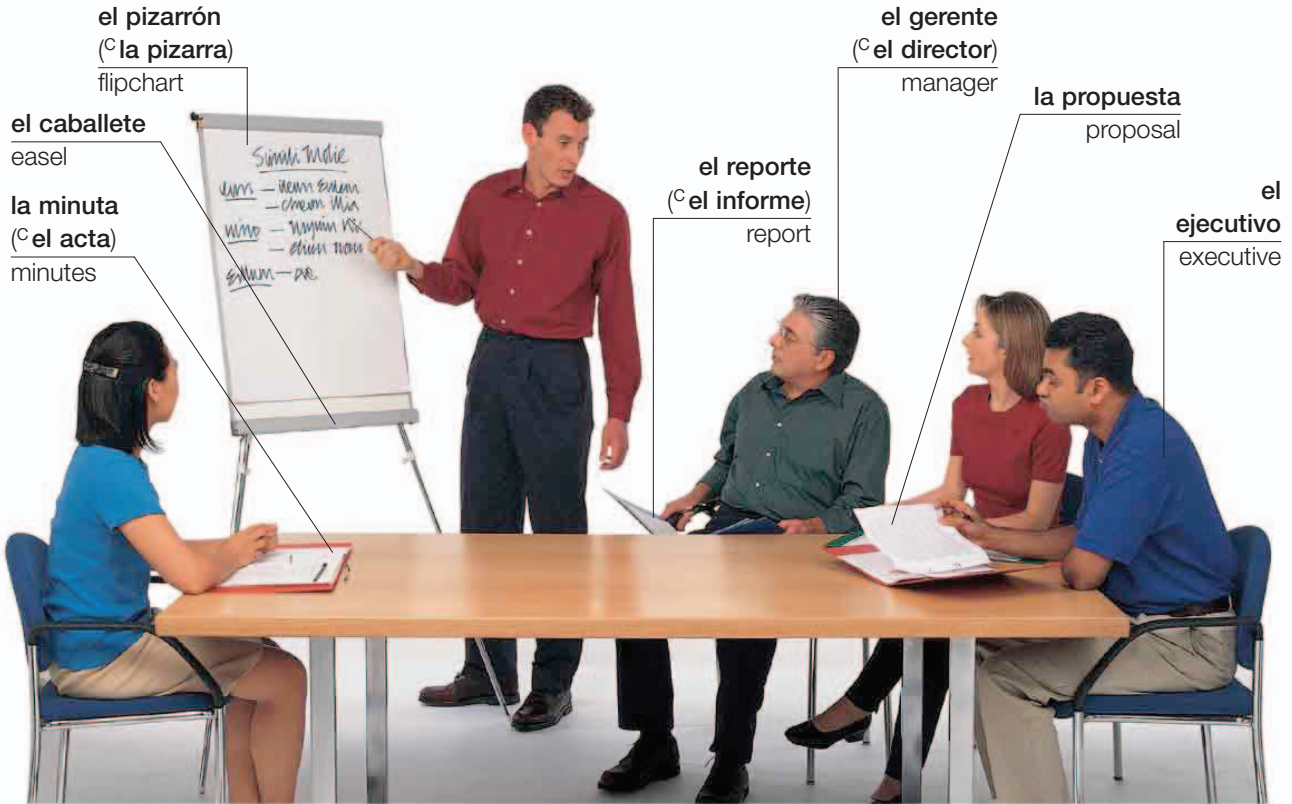

el pizarrón
(^o la pizarra)
flipchart

el caballete
easel

la minuta
(^o el acta)
minutes

el reporte
(^o el informe)
report

el gerente
(^o el director)
manager

la propuesta
proposal

el
ejecutivo
executive

la junta (^o la reunión) | meeting

vocabulario • vocabulary

el orden del día
agenda

asistir
attend (v)

la sala de juntas (^o reuniones)
meeting room

presidir
chair (v)

¿A qué hora es la junta (^o la reunión)?
What time is the meeting?

¿Cuál es su horario de oficina?
What are your office hours?

la oradora
speaker



la presentación | presentation

los negocios • business

el hombre de negocios
businessman

la mujer de negocios
businesswoman



la comida de negocios
business lunch



el viaje de negocios
business trip

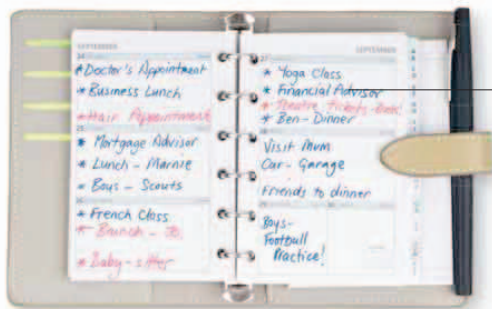

la agenda | date book

la cita
appointment

la clienta
client



el director general
managing director

el trato
business deal

vocabulario • vocabulary

la empresa
company

el personal
staff

el departamento de ventas
sales department

el departamento legal
legal department

la oficina central
head office

la nómina
payroll

el departamento de contabilidad
accounting department

el departamento de atención al cliente
customer service department

la sucursal
branch

el sueldo
salary

el departamento de márketing
marketing department

el departamento de recursos humanos
human resources department

la computadora (el ordenador) • computer

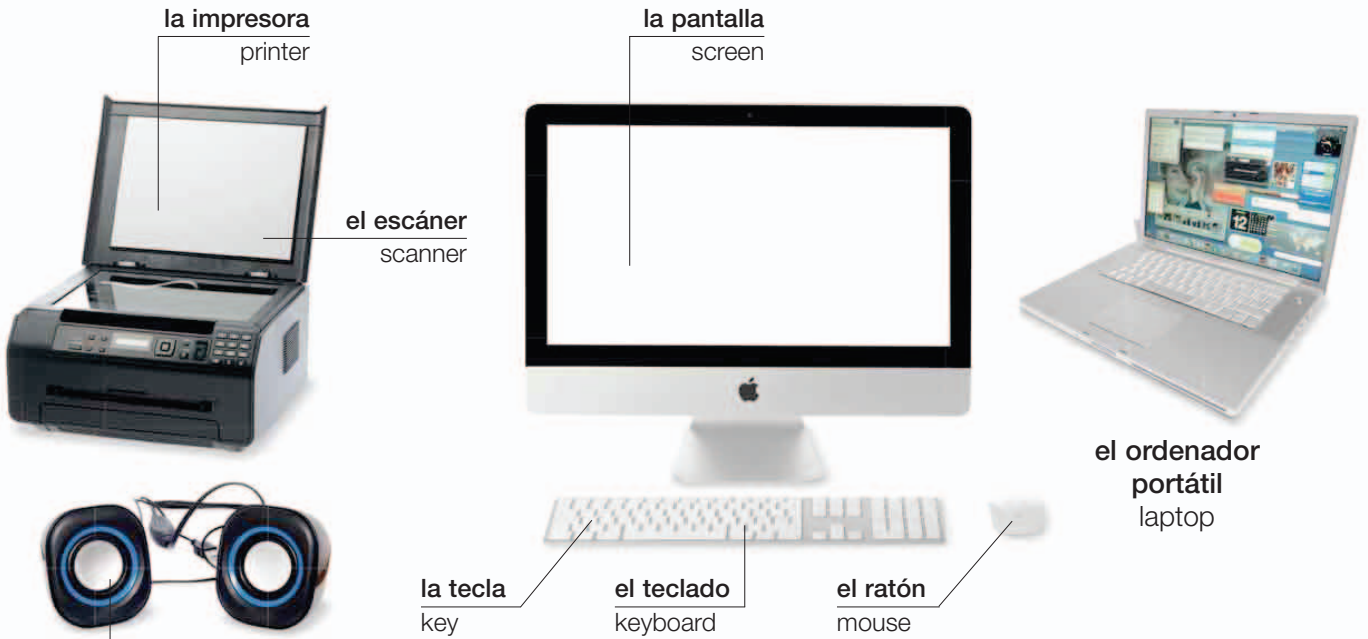

la bocina (el altavoz)
speaker

el hardware
hardware



la llave de memoria
memory stick



el disco duro externo
external hard drive

vocabulario • vocabulary		
la memoria memory	el software software	el servidor server
el RAM RAM	la aplicación application	el puerto port
los bytes bytes	el programa program	el procesador processor
el sistema system	la red network	el cable de alimentación power cable



el iPad®
iPad



el teléfono inteligente
smartphone

el escritorio • desktop

la barra del menú
menubar

la barra de herramientas
([©] de acceso)
toolbar

el fondo
wallpaper

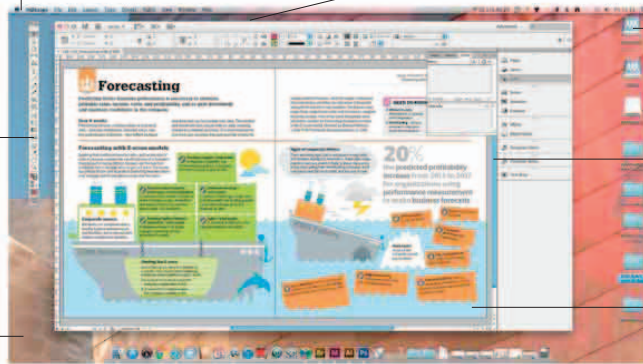

la fuente
font

el icono
icon

la barra de desplazamiento
scrollbar

la ventana
window



el archivo ([©] el fichero) | file



la carpeta
folder

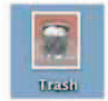

el basurero ([©] la papelera) | trash

el internet • Internet

el navegador
browser



navegar
browse (v)

la bandeja de entrada
inbox

el sitio web
website

el correo electrónico • email

la dirección electrónica
email address

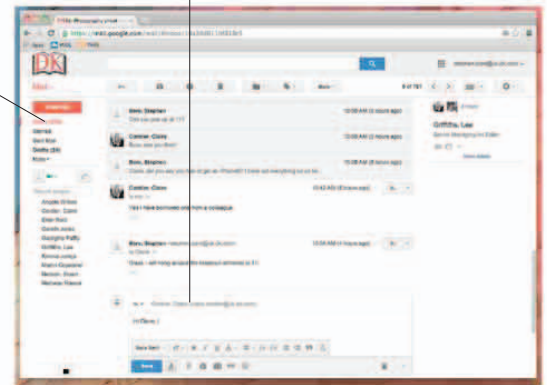

vocabulario • vocabulary

conectar
connect (v)

la cuenta de correo
email account

en línea
online

bajar
download (v)

enviar
send (v)

guardar
save (v)

instalar
install (v)

el proveedor de servicios
service provider

entrar en el sistema
log on (v)

el documento adjunto
attachment

recibir
receive (v)

buscar
search (v)

los medios de comunicación • media

el estudio de televisión • television studio



vocabulario • vocabulary

el canal
channel

el documental
documentary

la prensa
press

la telenovela
soap

el concurso
game show

en directo
live

la programación
programming

el noticiero
news

**la serie
televisiva**
television
series

transmitir
(° emitir)
broadcast (v)

las caricaturas
(° los dibujos
animados)
cartoon

pregrabado
(° en diferido)
prerecorded



el entrevistador
interviewer



la reportera
reporter



el teleprompter
([©] el autocue)
teleprompter



la presentadora de las noticias
anchor



los actores
actors



el micrófono de aire
([©] la jirafa) | sound boom



la pizarra ([©] la claqueta)
clapper board



el plató de rodaje
film set

la radio • radio

el técnico de sonido
sound technician

la consola
([©] la mesa de mezclas)
mixing desk

el micrófono
microphone



el estudio de grabación | recording studio

vocabulario • vocabulary

la estación de radio
radio station

la onda media
medium wave

el DJ ([©] el pinchadiscos)
DJ

la frecuencia
frequency

el volumen
volume

la transmisión
([©] la emisión)
broadcast

sintonizar
tune (v)

la longitud de onda
wavelength

analógico
analog

la onda larga
long wave

digital
digital

la onda corta
short wave

el derecho • law

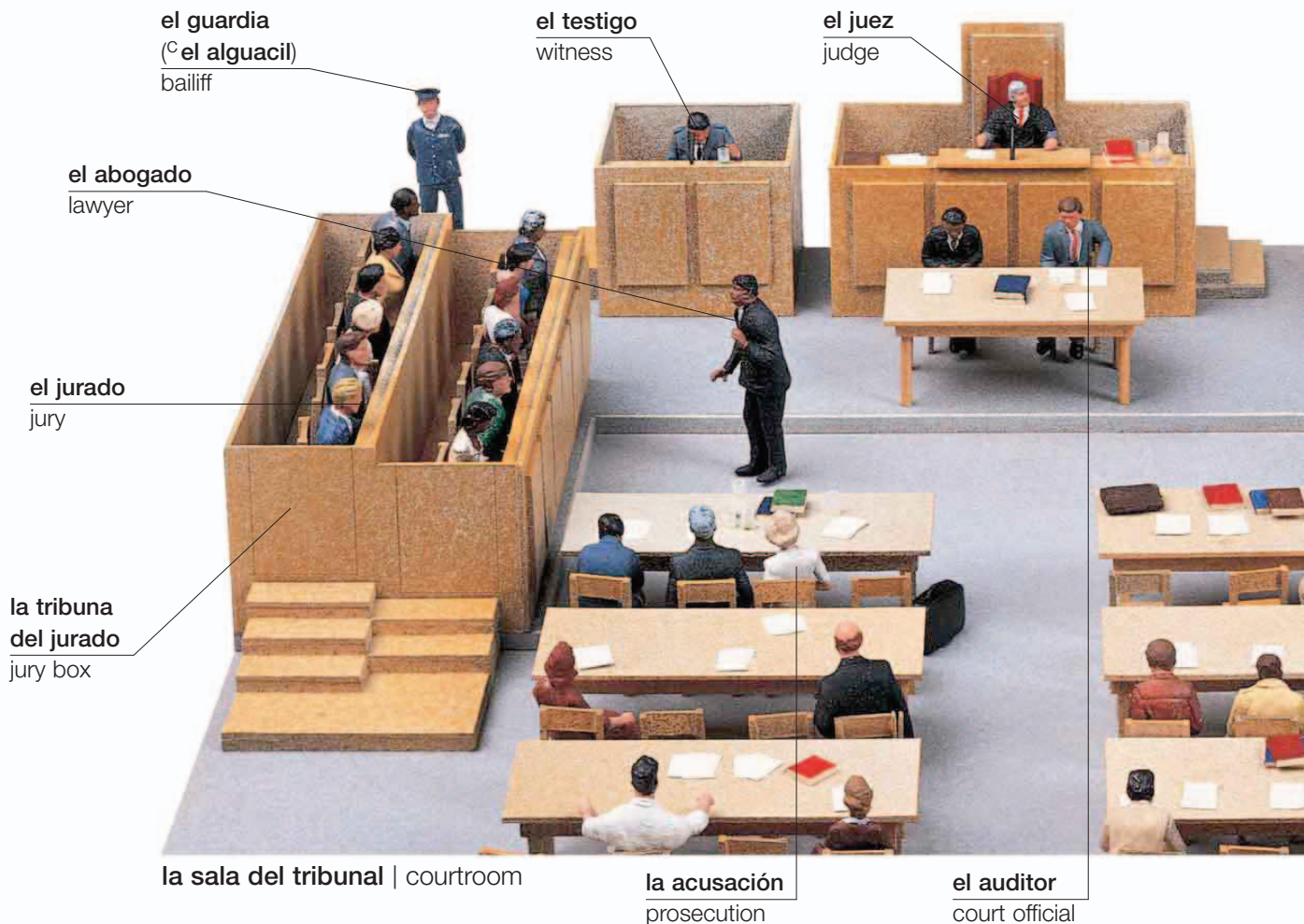

vocabulario • vocabulary

el bufete
lawyer's office

la citación
summons

la orden judicial
writ

el juicio
court case

la asesoría jurídica
legal advice

la declaración
statement

la fecha del juicio
court date

el cargo
charge

el cliente
client

la orden judicial
warrant

cómo se declara el acusado
plea

el acusado
accused

la taquígrafa
court reporter

el sospechoso
suspect

el acusado
defendant

la defensa
defense



el retrato hablado
(^o **el retrato robot**)
facial composite

el criminal
criminal



los antecedentes
criminal record

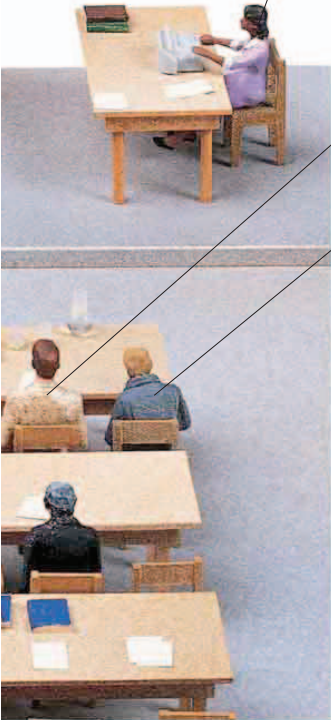

el celador (^o **el funcionario de prisiones**)
prison guard



la celda
cell

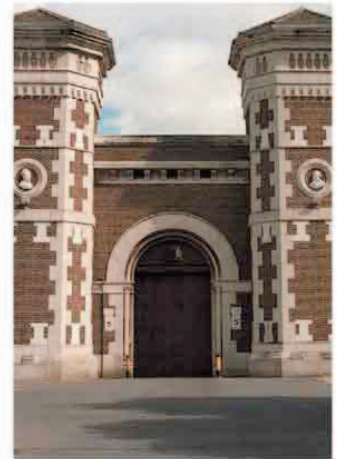

la cárcel
prison

vocabulario • vocabulary

el veredicto
verdict

absuelto
acquitted

la fianza
bail

Quiero ver a un abogado.
I want to see a lawyer.

inocente
innocent

la sentencia
sentence

la apelación
appeal

¿Dónde está el juzgado?
Where is the courthouse?

culpable
guilty

la evidencia
(^o **la prueba**)
evidence

la libertad condicional
parole

¿Puedo pagar la fianza?
Can I post bail?

la granja 1 • farm 1



el granjero
farmer

el huerto
vegetable
garden

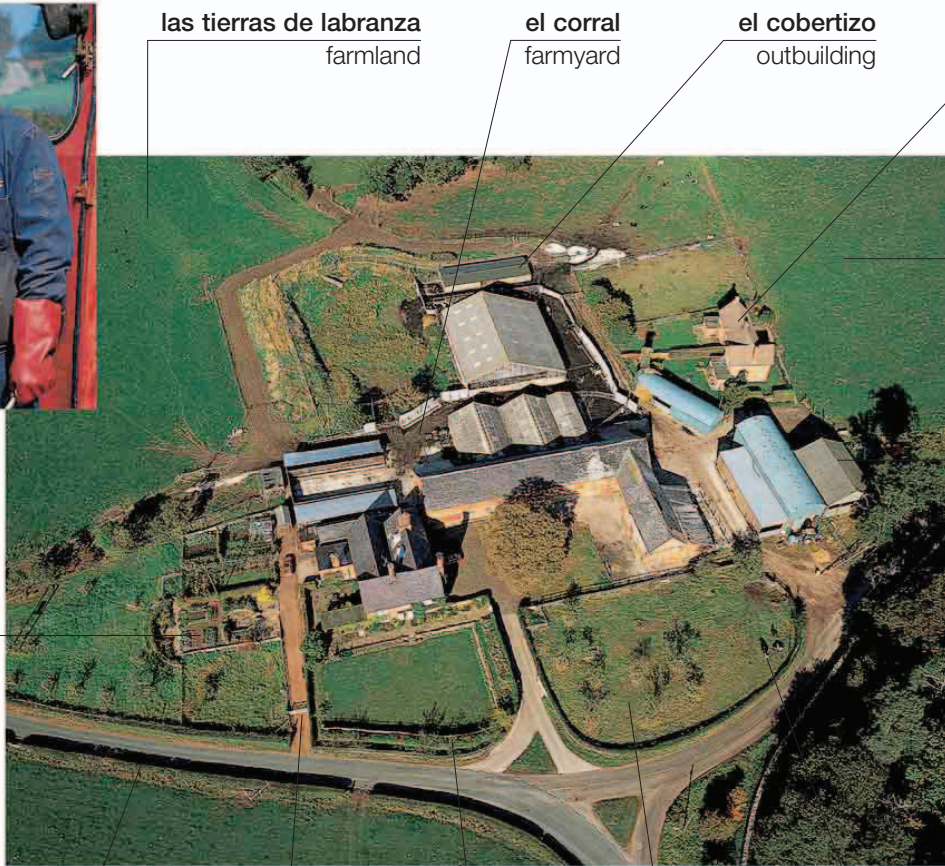

las tierras de labranza
farmland

el corral
farmyard

el cobertizo
outbuilding

la casa de labranza
farmhouse

el campo
field

el granero
barn

el seto
hedge

la puerta
gate

la cerca
fence

el pasto
pasture

el ganado
livestock



el tractor | tractor

el cultivador
cultivator



la cosechadora | combine

los tipos de granja • types of farms

la cosecha
crop



la granja de tierras
cultivables
crop farm



la vaquería
dairy farm

el rebaño
flock



la granja de ganado
ovino
sheep farm



la granja avícola
poultry farm

la viña
vine



la granja de ganado
porcino
pig farm



el criadero de peces
(^o la piscifactoría)
fish farm



la granja de frutales
fruit farm

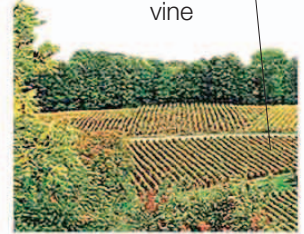

el viñedo
vineyard

las actividades • actions

el surco
furrow



arar
plow (v)



sembrar
sow (v)



ordeñar
milk (v)

alimentar (^o dar de comer)
feed (v)



regar | water (v)



recolectar | harvest (v)

vocabulario • vocabulary

el herbicida
herbicide

la manada
herd

el comedero
trough

el
pesticida
pesticide

el silo
silo

plantar
plant (v)

la granja 2 • farm 2

los cultivos • crops



el trigo
wheat



el maíz
corn



la cebada
barley



la colza
rapeseed



el girasol
sunflower



la paca
bale

el heno
hay



la alfalfa
alfalfa



el tabaco
tobacco



el arroz
rice



el té
tea



el café
coffee



el espantapájaros
scarecrow



el lino
flax



la caña de azúcar
sugarcane



el algodón
cotton

el ganado • livestock

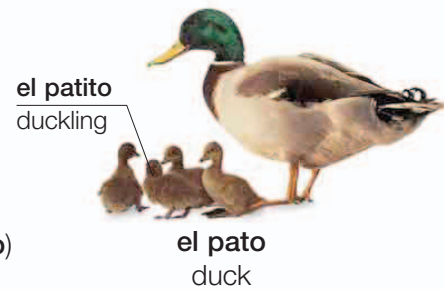
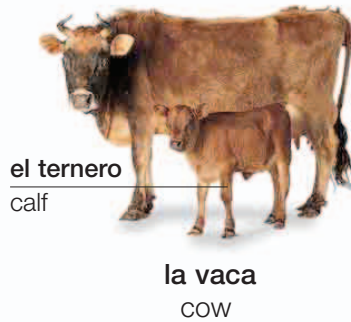
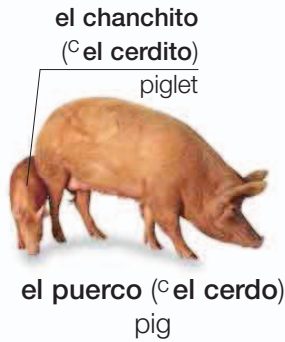

la construcción • construction

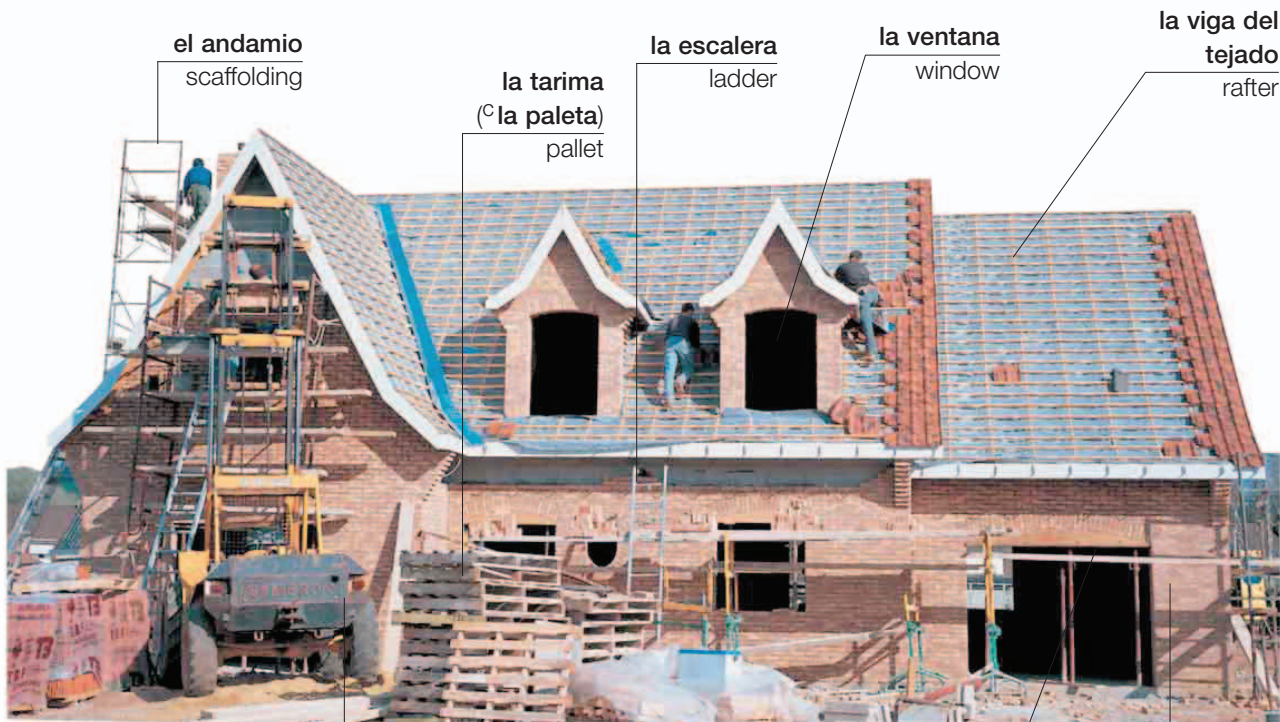

el andamio
scaffolding

la tarima
([©] la paleta)
pallet

la escalera
ladder

la ventana
window

la viga del
tejado
rafter

el montacargas
([©] la carretilla elevadora)
forklift

la obra
construction site

el dintel
lintel

la pared
wall

la viga de
acero
girder

el casco
hard hat

el cinturón de las
herramientas
toolbelt

la viga de madera
beam

el
cemento
cement



construir
build (v)



el albañil
construction worker



la mezcladora de cemento
([©] la hormigonera)
cement mixer

los materiales • materials



el ladrillo
brick



la madera
timber



la teja
roof tile



el bloque de hormigón
cinder block

las herramientas • tools

la argamasa
mortar

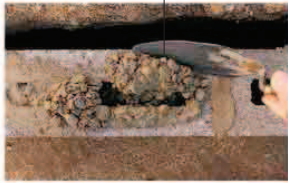

la paleta
trowel



el nivel
spirit level



el mazo
sledgehammer



el mango
handle

el zapapico
([©]el pico)
pickax



la pala
shovel

la maquinaria • machinery



la aplanadora
([©]la apisonadora)
steam roller



el camión de volteo
([©]el camión volquete)
dump truck

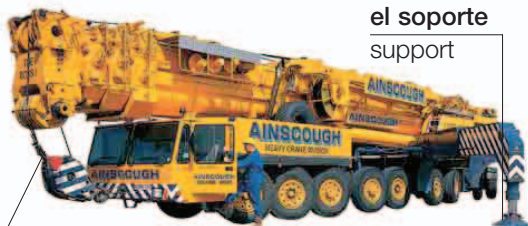

el gancho
hook

la grúa | crane

el soporte
support

las obras viales ([©]las obras) • roadwork

el asfalto
tarmac

el cono
cone



el martillo
neumático
pneumatic drill

el revestimiento
resurfacing



la pala mecánica
([©]la excavadora
mecánica)
mechanical digger

los profesiones 1 • occupations 1



el carpintero
carpenter



el electricista
electrician



el plomero (el fontanero)
plumber



el albañil
construction worker



el jardinero
gardener

la
aspiradora
vacuum
cleaner



**el empleado de la
limpieza**
cleaner



el mecánico
mechanic



el carnicero
butcher



el estilista
(el peluquero)
hairdresser



la pescadera
fishmonger



el frutero
greengrocer



la florista
florist



el peluquero
(el barbero)
barber



el joyero
jeweler



la vendedora
sales assistant



la agente inmobiliario
estate agent



el optometrista
(^cel óptico) | optician



la dentista
dentist

la mascarilla
mask



el médico
doctor



la farmacéutica
pharmacist



la enfermera
nurse



la veterinaria
vet



el agricultor
farmer



el pescador
fisherman

la metralleta
machine gun



el soldado
soldier



el policía
policeman

la placa de identificación
identity card

el uniforme
uniform



el guardia de seguridad
security guard



el marino
sailor



el bombero
fireman

las profesiones 2 • occupations 2



el abogado
lawyer



el contador (c el contable)
accountant



la maqueta
model

el arquitecto
architect



la científica
scientist



la maestra (c la profesora)
teacher



el bibliotecario
librarian



la recepcionista
receptionist



**la
cartera**
mailbag

el cartero
mail carrier



el chófer
bus driver



el chófer
(c el camionero)
truck driver



el taxista
taxi driver



el piloto
pilot



la sobrecargo
(c la azafata)
flight attendant



la agente de viajes
travel agent

**el gorro de
cocinero**
chef's hat



el chef
chef



el músico
musician



el tutú
tutu

la bailarina
dancer



la actriz
actress



la cantante
singer



la mesera
(^cla camarera)
waitress



el barman
(^cel camarero)
barman



el deportista
sportsman



el escultor
sculptor



la pintora
painter



el fotógrafo
photographer



la presentadora
anchor



las notas
notes

el periodista
journalist



la redactora
editor



el diseñador
designer



la modista
seamstress

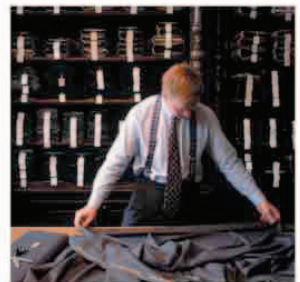

el sastre
tailor





el transporte
transportation

las carreteras • roads

la autopista
highway

la caseta de cobro (C de peaje)
toll booth

las señales de piso
(C las señales horizontales)
road markings

la entrada
(C la vía de acceso)
entrance ramp

de sentido único
one-way

la línea divisoria
divider

el cruce
(C la salida)
junction

el semáforo
traffic light

el camión
truck

el muro de división
(C la mediana)
median strip

el carril de baja
(C el carril para el tráfico lento)
inside lane

el carril central
middle lane

el carril izquierdo
(C el carril de adelantamiento)
outside lane

la rampa de salida
(C la vía de salida)
exit ramp

el tránsito
(C el tráfico)
traffic

el puente
(C el paso elevado)
overpass

el acotamiento
(C el arcén)
hard shoulder

el paso a desnivel
(C el paso subterráneo)
underpass





el paso de peatones
crosswalk



el teléfono de emergencia
emergency phone



el estacionamiento (° el aparcamiento) para minusválidos
disabled parking place



el tráfico (° el atasco de tráfico)
traffic jam



el navegador por satélite
satnav



el parquímetro
parking meter



el policía de tránsito (° el policía de tráfico)
traffic policeman

vocabulario • vocabulary

la desviación (° el desvío)
detour

manejar (° conducir)
drive (v)

remolcar
tow away (v)

estacionar (° aparcar)
park (v)

rebasar (° adelantar)
pass (v)

la autovía
divided highway

¿Es ésta la carretera hacia...?
Is this the road to...?

la glorieta
rotary

las obras
roadworks

¿Dónde me puedo estacionar (° aparcar)?
Where can I park?

meter reversa (° dar marcha atrás)
reverse (v)

el muro de contención (° la barrera de seguridad)
guardrail

las señales de tránsito • road signs



prohibido el paso
no entry



el límite de velocidad
speed limit



peligro
hazard



prohibido parar
no stopping



no dar vuelta (° no torcer) a la derecha
no right turn

el autobús • bus

el asiento del conductor
driver's seat

la barandilla
handrail

la puerta automática
automatic door

la rueda delantera
front wheel

el portaequipaje
luggage hold



la puerta | door



el autocar | bus

los tipos de autobuses • types of buses

el número de ruta
route number



el autobús de dos pisos
double-decker bus

el chófer
(el conductor)
driver



el tranvía
tram



el trolebús
streetcar



el autobús escolar | school bus

la rueda trasera
rear wheel

la ventanilla
(= la ventana)
window

el botón de
parada
stop button



el boleto (= el
billete) de autobús
bus ticket

el timbre
bell



la estación de autobuses
bus station



la parada de
autobús
bus stop

vocabulario • vocabulary

la tarifa
fare

la marquesina
bus shelter

el horario
timetable

la rampa para sillas de
ruedas
wheelchair access

¿Para usted en...?
Do you stop at...?

¿Qué autobús va a...?
Which bus goes to...?



el microbús
minibus



el autobús directo (= de enlace) | shuttle bus



el autobús turístico | tourist bus

el carro (el coche) 1 • car 1

el exterior • exterior

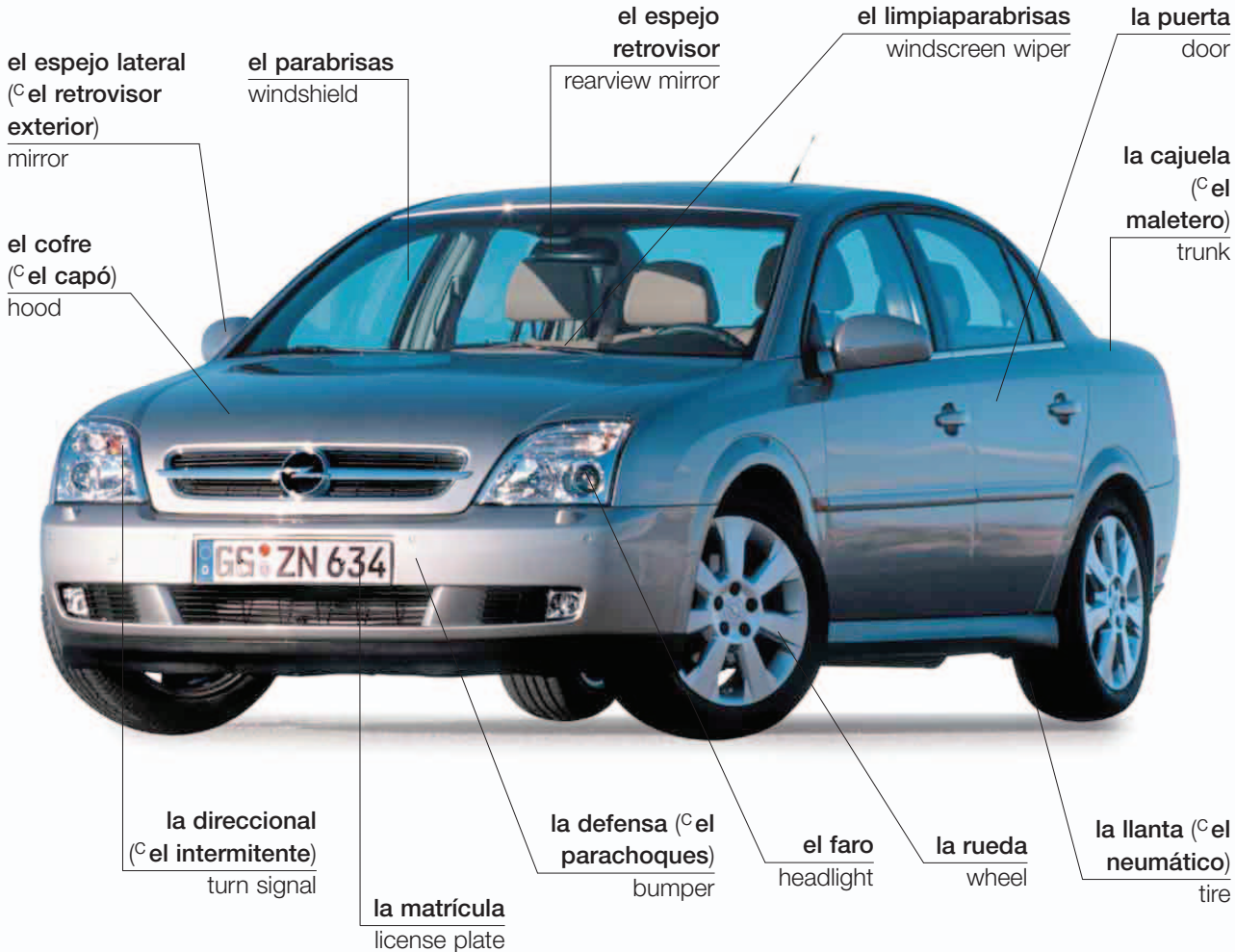

la baca
roof rack



la puerta abatible
(el maletero)
tailgate



el cinturón de
seguridad
seat belt



la silla para niños
child seat

los modelos • types



el coche eléctrico
electric car



el carro (°el coche)
de cinco puertas
hatchback



el carro familiar
(°el turismo)
sedan



la camioneta
(°el coche ranchera)
station wagon



el convertible
(°el coche descapotable)
convertible



el carro deportivo
sports car



la minivan
(°el monovolumen)
minivan



la doble tracción
(°el todoterreno)
four-wheel drive

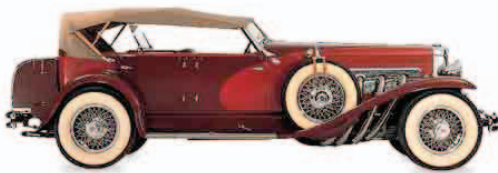

el auto (°el coche) de época
vintage



la limousine
limousine

la gasolinera • gas station

la bomba
(°el surtidor)
gas pump

el precio
price



la zona de abastecimiento
forecourt

vocabulario • vocabulary

el aceite
oil

el diesel
diesel

el anticongelante
antifreeze

la gasolina
gasoline

con plomo
leaded

el auto-lavado
(°el lavadero de coches)
car wash

sin plomo
unleaded

el taller
garage

el líquido limpiaparabrisas
windshield wiper fluid

Llénelo (°Lleno) por favor.
Fill it up, please.

el carro (C el coche) 2 • car 2

el interior • interior

el asiento trasero
backseat

el reposabrazos
armrest

el reposacabezas
headrest

el seguro
(C el pestillo)
door lock

la manija
(C el tirador)
handle



vocabulario • vocabulary

dos puertas
two-door

de cuatro
puertas
four-door

automático
automatic

el freno
brake

el acelerador
accelerator

de tres
puertas
three-door

manual
manual

el
encendido
ignition

el
embrague
clutch

el aire
acondicionado
air-conditioning

¿Me puede decir cómo se va a...?
Can you tell me the way to...?

¿Dónde hay un
estacionamiento (C parking)?
Where is the parking lot?

¿Se puede estacionar
(C aparcar) aquí?
Can I park here?

los controles • controls

el volante
steering wheel

el claxon
(^o la bocina)
horn

el tablero
(^o el salpicadero)
dashboard

las luces de emergencia
hazard lights

la navegación por satélite
satellite navigation



el volante a la izquierda | left-hand drive

el indicador de temperatura
temperature gauge

el tacómetro
(^o el cuentarrevoluciones)
tachometer

el velocímetro
(^o el indicador de velocidad)
speedometer

el indicador de la gasolina
fuel gauge

la radio del coche
car stereo

la palanca (^o el conmutador) de luces
light switch

la calefacción
heater controls

el odómetro
(^o el cuenta-kilómetros)
odometer

la palanca de velocidades
(^o de cambios)
gearshift

la bolsa de aire
(^o el airbag)
air bag



el volante a la derecha | right-hand drive

el carro (C el coche) 3 • car 3

la mecánica • mechanics

el depósito del
limpiaparabrisas
washer fluid reservoir

la varilla del nivel del
aceite
dipstick

el filtro del
aire
air filter

el depósito del líquido de
frenos
brake fluid reservoir

la batería
battery

la chapa
bodywork



el depósito del líquido
refrigerante
coolant reservoir

la culata
cylinder head

el tubo
pipe

el quemacocos
(C el techo solar)
sunroof

el radiador
radiator

el ventilador
fan

el motor
engine

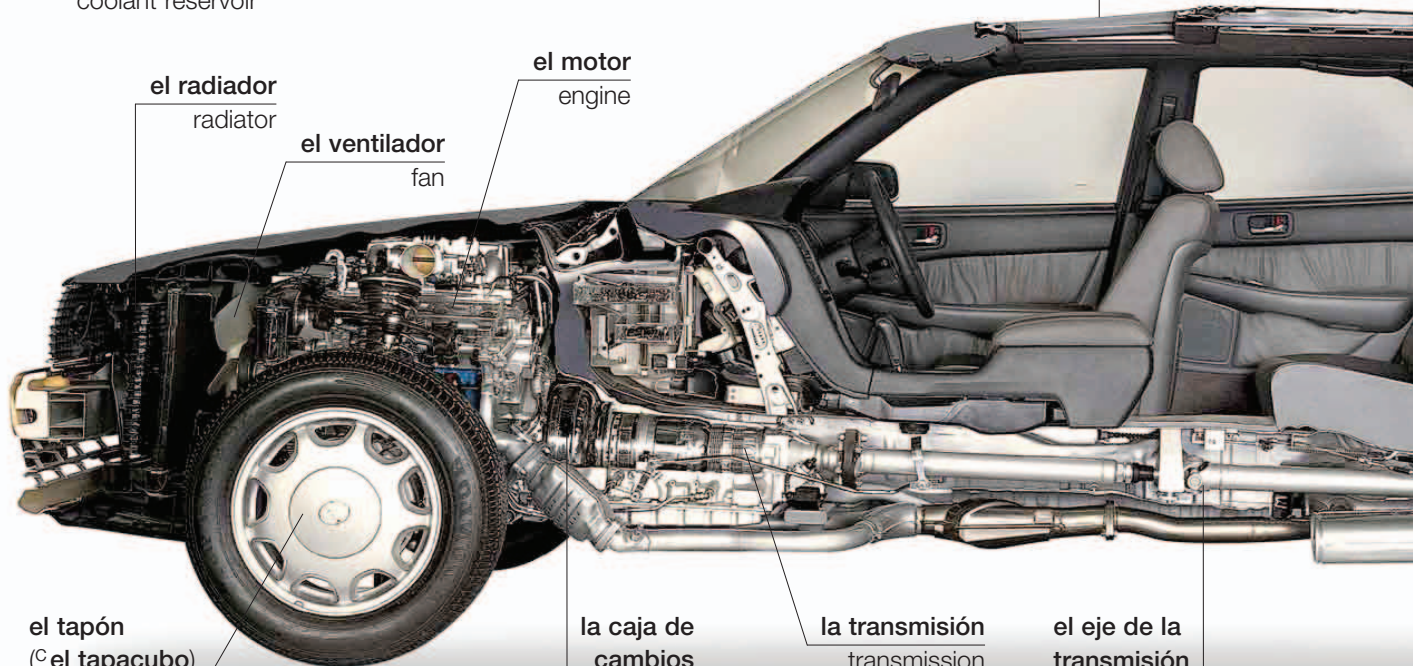

el tapón
(C el tapacubo)
hubcap

la caja de
cambios
gearbox

la transmisión
transmission

el eje de la
transmisión
drive shaft

la ponchadura (c el pinchazo) • flat tire

la llanta de refacción
(c la rueda de repuesto)
spare tire



la llave
tire iron

los birlos (c los tornillos)
wheel lugs

el gato
jack

cambiar una llanta (c una rueda)
change a tire (v)

el techo
roof

la suspensión
suspension

el silenciador
muffler

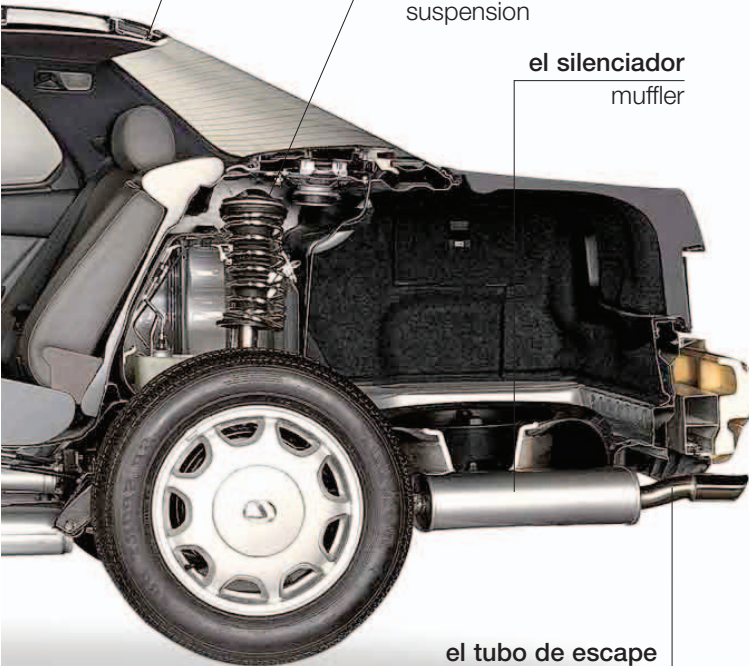

el tubo de escape
exhaust pipe

vocabulario • vocabulary

el accidente de
carro
car accident

el tanque de la
gasolina
petrol tank

la avería
breakdown

el turbo
turbocharger

el seguro
insurance

el distribuidor
distributor

la grúa
tow truck

el ralentí
timing

el mecánico
mechanic

el chasis
chassis

la presión del
neumático
tire pressure

la banda del disco
(c la correa del disco)
cam belt

la caja de fusibles
fuse box

el freno de mano
parking brake

la bujía
spark plug

la banda del
ventilador (c la correa
del ventilador)

el alternador
alternator

fan belt

Se descompuso el carro.
(c Mi coche se ha averiado.)
My car has broken down.

El carro no arranca.
(c Mi coche no arranca.)
My car won't start.

la motocicleta • motorcycle

la direccional
(^c el intermitente)
turn signal

el embrague
clutch

el velocímetro
(^c el cuenta-
kilómetros)
speedometer



los controles
controls

el freno
brake

el claxon
horn

el acelerador
throttle

el casco
helmet



el portaequipaje
carrier

el reflector
(^c el captafaros)
reflector

el asiento trasero
passenger seat

el asiento
seat

el motor
engine

el tanque de la
gasolina
fuel tank

la luz trasera
taillight

el tubo de escape
exhaust pipe

el silenciador
muffler

el depósito del aceite
oil tank

la caja de velocidades
(^c de cambios)
gearbox

el filtro del aire
air filter

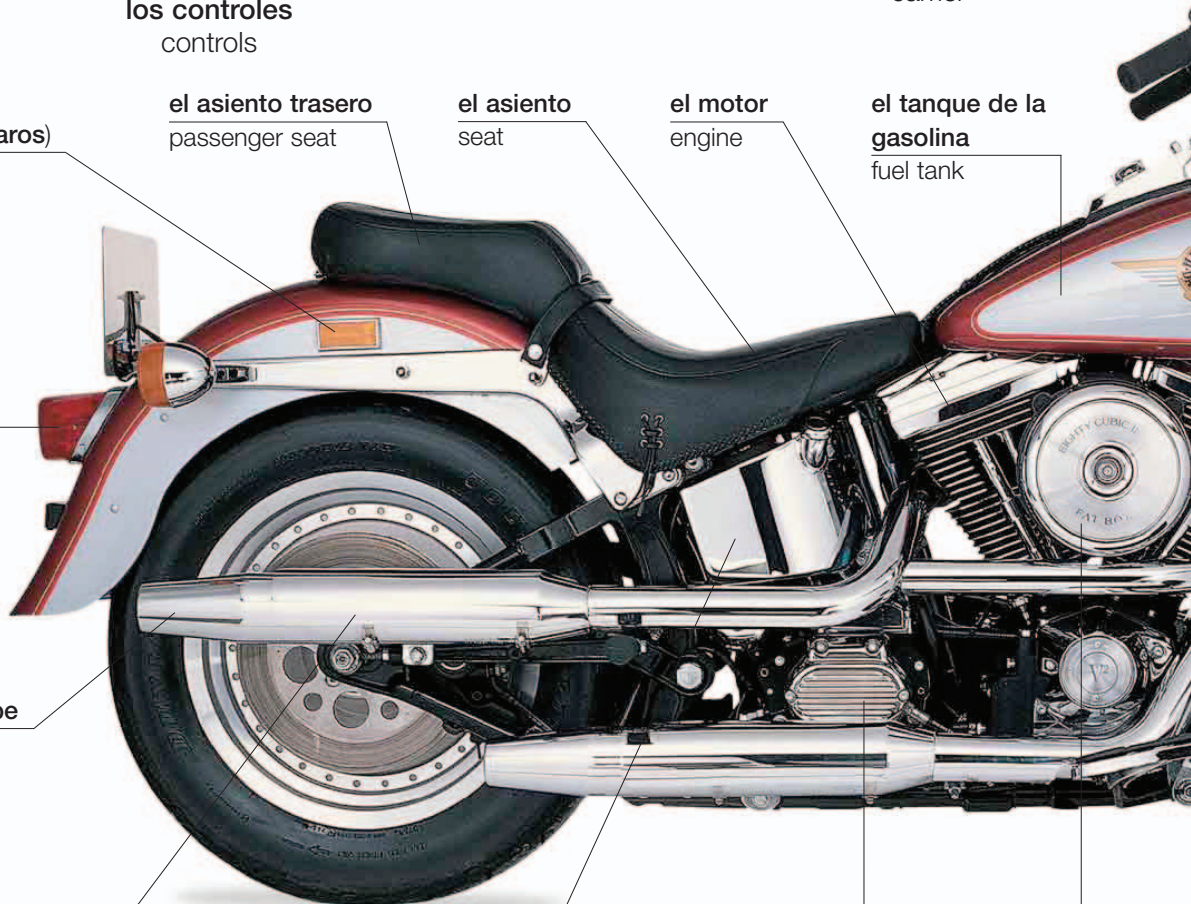

los tipos • types



el equipo | clothing

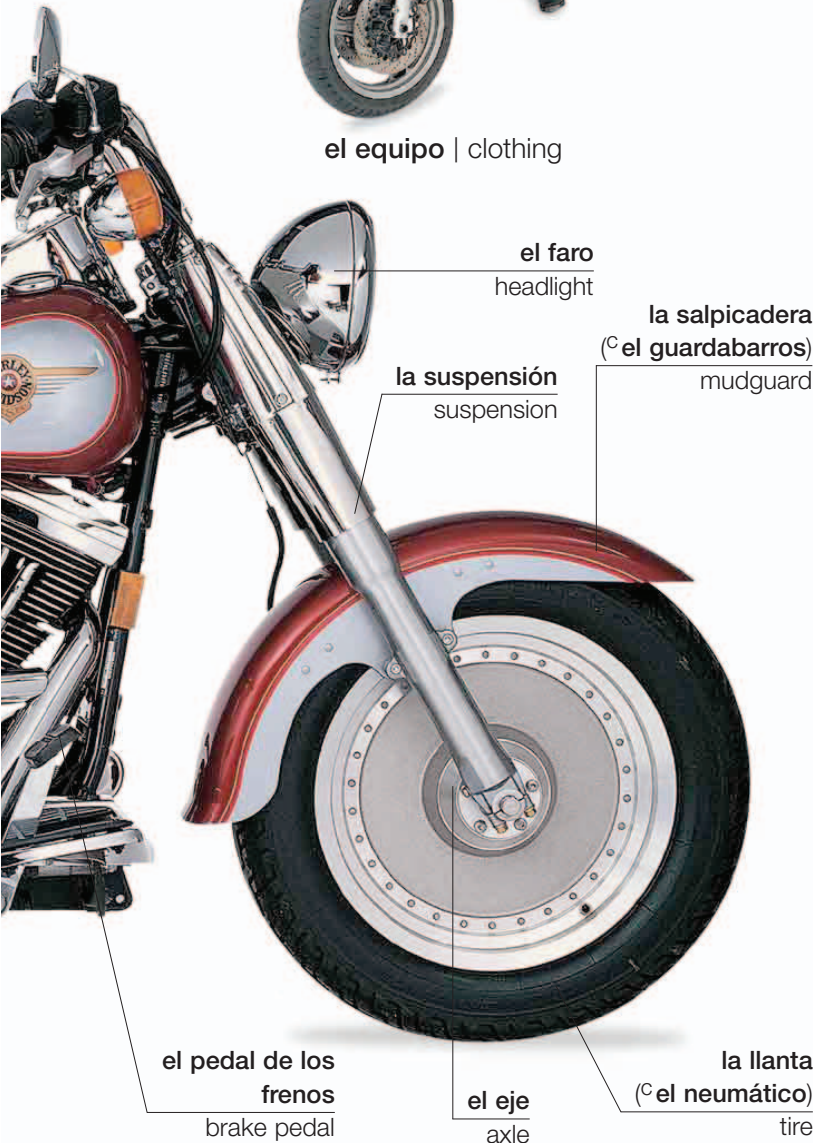

la moto de carreras | racing bike

el parabrisas
windshield



la moto de carretera | tourer



la motocross | dirt bike

el soporte
stand



la vespa | scooter

la bicicleta • bicycle



el tándem
tandem



la bicicleta de carreras
racing bike



la bicicleta de montaña
mountain bike



la bicicleta de paseo
touring bike



la bicicleta de pista
(de carretera)
road bike

el asiento (el sillín)
saddle

el poste del asiento
(el soporte del sillín)
seat post

la botella del agua
water bottle

el cuadro
frame

el freno
brake

el eje
hub

los cambios
(las marchas)
gears

el rin
rim

la llanta
(la cubierta)
tire

la cadena
chain

el pedal
pedal

la estrella (el diente de la rueda)
cog

el casco
helmet



el carril de bicicletas | cycle lane



el kit de reparaciones | repair kit

vocabulario • vocabulary

el faro light	el cable cable	el engrane ([©] el piñón) sprocket	la dinamo dynamo	el calzapié toe clip	frenar brake (v)
el faro trasero rear light	el reflector ([©] el captafaros) reflector	las ruedas de apoyo stabilizers	la canastilla ([©] la cesta) basket	la banda del calzapié ([©] la correa del calzapié) toe strap	andar ([©] ir) en bicicleta cycle (v)
la patilla de apoyo kickstand	el rack ([©] la baca) para bicicletas bike rack	la goma ([©] el taco) del freno brake block	la ponchadura ([©] el pinchazo) flat tire	pedalear pedal (v)	cambiar de velocidad ([©] marcha) change gear (v)

el tren • train

el vagón
carriage

el andén
platform

el carrito
cart



el número de andén
platform number

el viajero de cercanías
commuter

la estación de tren | train station

los tipos de tren • types of train



el tren de vapor
steam train

la locomotora
engine



el tren diesel | diesel train

la cabina del conductor
conductor's cabin

el riel (° el raíl)
rail



el tren eléctrico
electric train



el tren de alta velocidad
high-speed train



el monorriel (° el monorraíl)
monorail



el metro
underground train



el tranvía
streetcar



el tren de carga
(° el tren de mercancías)
freight train



el portaequipajes
luggage rack

la ventanilla
window

la vía
track

la puerta
door

el asiento
seat

el compartimento
compartment

el altavoz (° el sistema de megafonía)
public address system

el horario
timetable



el boleto (° el billete)
ticket



la barrera
ticket barrier



el vagón restaurante | dining car



el vestíbulo | concourse



el cochecama
sleeping compartment

vocabulario • vocabulary

la red ferroviaria
railroad network

el plano del metro
underground map

la taquilla
ticket office

el riel electrificado
live rail

el tren intercity
inter-city train

el retraso
delay

cambiar
change (v)

la señal
signal

la hora pico
(° la hora punta)
rush hour

el precio
fare

el checador
(° el revisor)
ticket inspector

la palanca de emergencia
emergency lever

el avión • aircraft

el avión de pasajeros • airliner



la cabina • cabin





el globo aerostático
hot-air balloon



el ultraligero
ultralight



el planeador
glider



el biplano
biplane

la hélice
propeller



la avioneta
light aircraft



el hidroavión
seaplane



el jet privado
private jet



el misil
missile

el caza
fighter plane

el aspa
rotor blade



el helicóptero
helicopter



el avión de bombardeo
bomber

vocabulario • vocabulary

el piloto
pilot

despegar
take off (v)

aterrizar
land (v)

la clase turista
economy class

el equipaje de mano
carry-on luggage

el copiloto
copilot

volar
fly (v)

la altitud
altitude

la clase preferente
business class

el cinturón de seguridad
seatbelt

el aeropuerto • airport



la pista de estacionamiento
apron

el remolque del equipaje
baggage trailer

la terminal
terminal

el vehículo de servicio
service vehicle

la pasarela
jetway

el avión de línea | airliner

vocabulario • vocabulary

la pista
runway

la aduana
customs

la seguridad
security

las vacaciones
vacation

el vuelo internacional
international flight

el número de vuelo
flight number

la banda transportadora
([©] la cinta de equipajes)
baggage carousel

reservar un vuelo
make a flight reservation (v)

el vuelo nacional
domestic flight

inmigración
immigration

la máquina de rayos x
X-ray machine

la torre de control
control tower (v)

la conexión
connection

el exceso de equipaje
excess baggage

el folleto de viajes
travel brochure

hacer check-in
([©] facturar)
check in (v)

el equipaje de mano
carry-on luggage

el equipaje
luggage

el carrito
(el carro)
cart



el mostrador de check-in
check-in desk



el pasaporte | passport

la visa
(el visado)
visa



el control de pasaportes
passport control

la tarjeta de embarque
boarding pass



el boleto (el billete)
ticket



la sala de embarque
departure lounge

el número de puerta de embarque
gate number

las salidas
departures



la pantalla informativa
information screen

el destino
destination

las llegadas
arrivals



el duty-free (la tienda libre de impuestos)
duty-free store



la recogida de equipajes
baggage claim



el sitio de taxis
(la parada de taxis)
taxi stand



la renta de carros
(el alquiler de coches)
car rental

el barco • ship

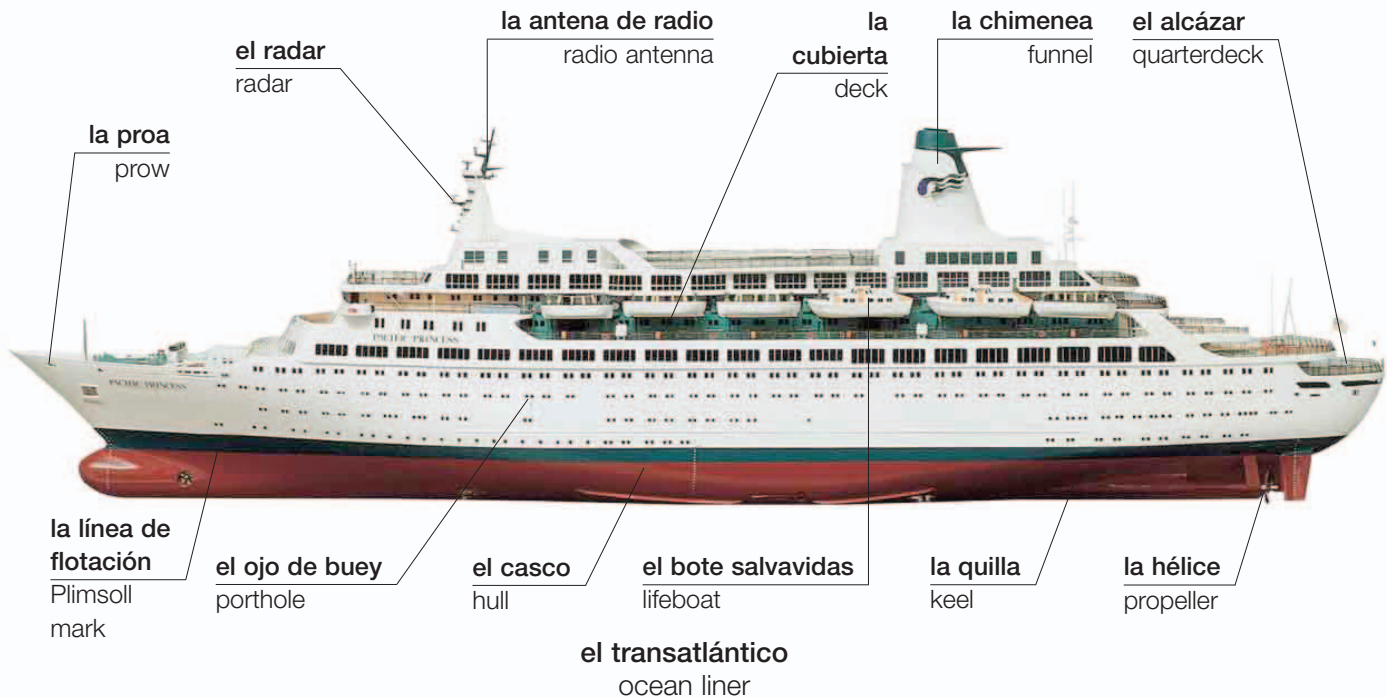

el puente
bridge



la sala de máquinas
engine room



el camarote
cabin



la cocina
galley

vocabulario • vocabulary

el muelle
dock

el cabrestante
windlass

el puerto
port

el capitán
captain

la pasarela
gangway

la lancha de motor
el capitán

el ancla
anchor

la barca de remos
rowboat

el noray
bollard

la piragua
canoe

otras embarcaciones • other ships



el ferry
ferryboat

el motor fueraborda
outboard motor



la zodiac
inflatable dinghy



el hidrodeslizador
hydrofoil



el yate
yacht



el catamarán
catamaran



el remolcador
tugboat



el aerodeslizador
hovercraft



el barco carguero (c el buque portacontenedores)
container ship

las jarcias
rigging



el barco de vela
sailboat

la bodega
hold



el buque de carga
freighter



el buque tanque
(c el petrolero)
oil tanker



el portaaviones
aircraft carrier



el barco de guerra
battleship

la falsa torre
conning tower



el submarino
submarine

el puerto • port

la bodega
(^c el almacén)
warehouse

la grúa
crane

la carretilla elevadora
forklift

la vía de acceso
access road

las aduanas
del puerto
customs house



la dársena
dock

el contenedor
container

el muelle
quay

la carga
cargo



el muelle comercial | containerport

la terminal del ferry
ferry terminal

el ferry
ferryboat

la ventanilla
de boletos
(^c de pasajes)
ticket office

el pasajero
passenger



el muelle de pasajeros | passenger port

la red
net

el barco pesquero
(^cel barco de pesca)
fishing boat

el punto de amarre
mooring



el puerto deportivo
marina



el puerto
harbor

el puerto pesquero (^cel puerto de pesca)
fishing port



el embarcadero
pier



el espigón
jetty



el astillero
shipyard



el faro
lighthouse

la lámpara
lantern



la boya
buoy

vocabulario • vocabulary

el guardacostas
coast guard

el dique seco
dry dock

embarcar
board (v)

el capitán del puerto
harbormaster

amarrar
moor (v)

desembarcar
disembark (v)

anclar (^cfondear)
drop anchor (v)

atracar
dock (v)

zarpar
set sail (v)





los deportes
sports



el fútbol americano • football

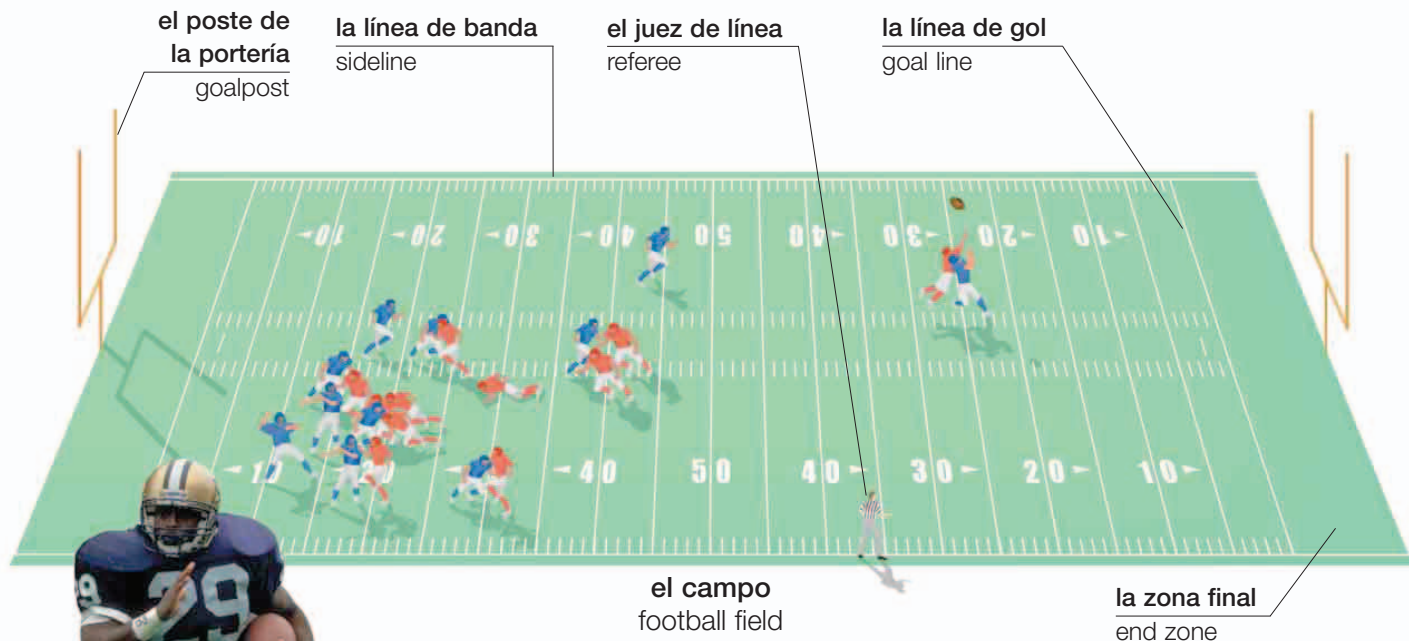

el balón
football

las rodilleras
pads

el casco
helmet

los tenis
(^cla bota)
cleat



taclear (^cplacar)
tackle (v)



pasar
pass (v)



atrapar (^ccoger)
catch (v)

el jugador
football player

vocabulario • vocabulary

el tiempo fuera
time out

el equipo
team

la defensa
defense

el intento
touchdown

¿Cómo van?
What is the score?

el balón perdido
fumble

el ataque
attack

la puntuación
score

la porrista
(^cla animadora)
cheerleader

¿Quién va ganando?
Who is winning?

el rugby • rugby

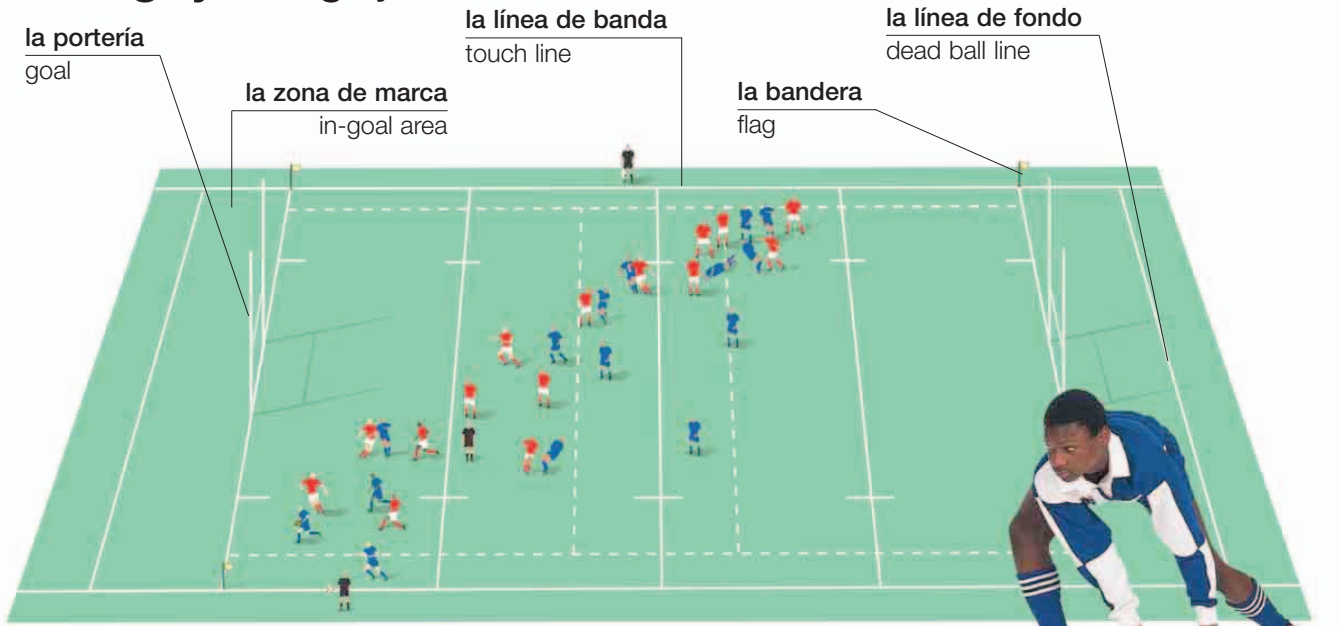

el campo de rugby | rugby field

el balón
ball



patear (C chutar)
kick (v)

el uniforme de
rugby
rugby uniform



pasar
pass (v)



taclear (C placar)
tackle (v)

lanzar
throw (v)



el intento (C el ensayo)
try

el jugador
player



la abierta | ruck



la cerrada (C la melée) | scrum

el fútbol • soccer



el balón
soccer ball

el delantero
forward

el árbitro
referee

el círculo central
center circle

el portero
goalkeeper

el uniforme
soccer uniform



el futbolista
soccer player

el campo de fútbol
soccer field

el poste
goalpost

la red
net

el larguero
crossbar



el gol | goal



regatear | dribble (v)



cabecear (c tirar de cabeza) | head (v)



la barrera
wall

el tiro libre | free kick

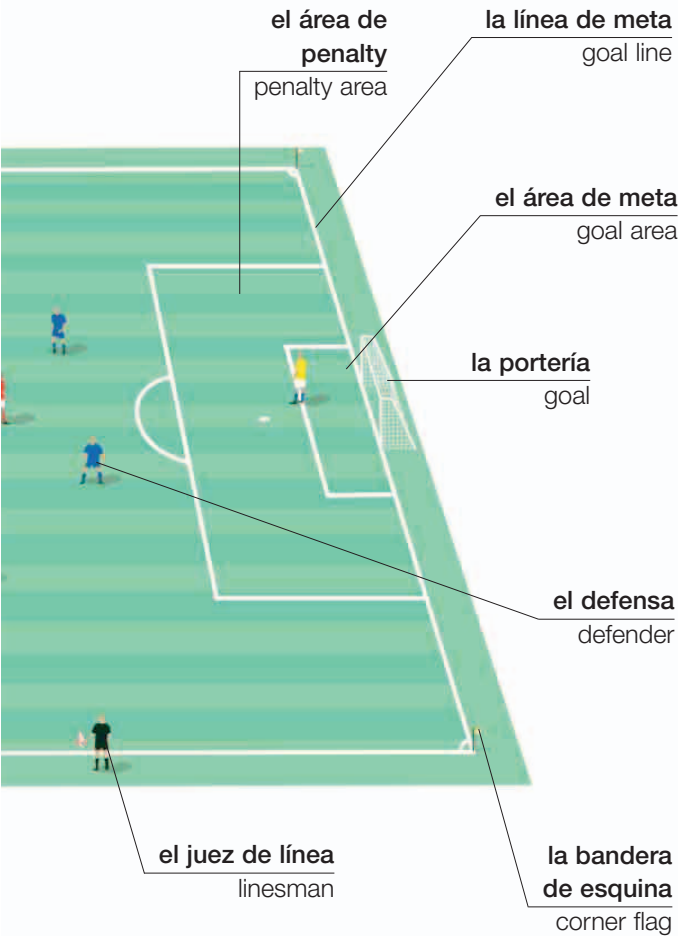

el saque de banda
throw-in



patear (° chutar)
kick (v)



mandar (° hacer) un pase
pass (v)

los tacos
cleat



tirar
shoot (v)



parar (° hacer una parada)
save (v)

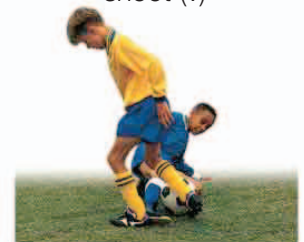

hacer una entrada
tackle (v)

vocabulario • vocabulary

el estadio
stadium

la tarjeta amarilla
yellow card

la falta
foul

la liga
league

el reserva
substitute

marcar un gol
score a goal (v)

la tarjeta roja
red card

el fuera de juego
offside

el empate
draw

el cambio
substitution

el penalty
penalty

el tiro de esquina
(° el córner)
corner

la expulsión
send off

el descanso
halftime

el tiempo extra
(° la prórroga)
extra time

el hockey • hockey

el hockey sobre hielo • ice hockey



el hockey sobre pasto • field hockey

el palo de hockey
hockey stick



patinar
skate (v)

golpear
hit (v)

el críquet • cricket

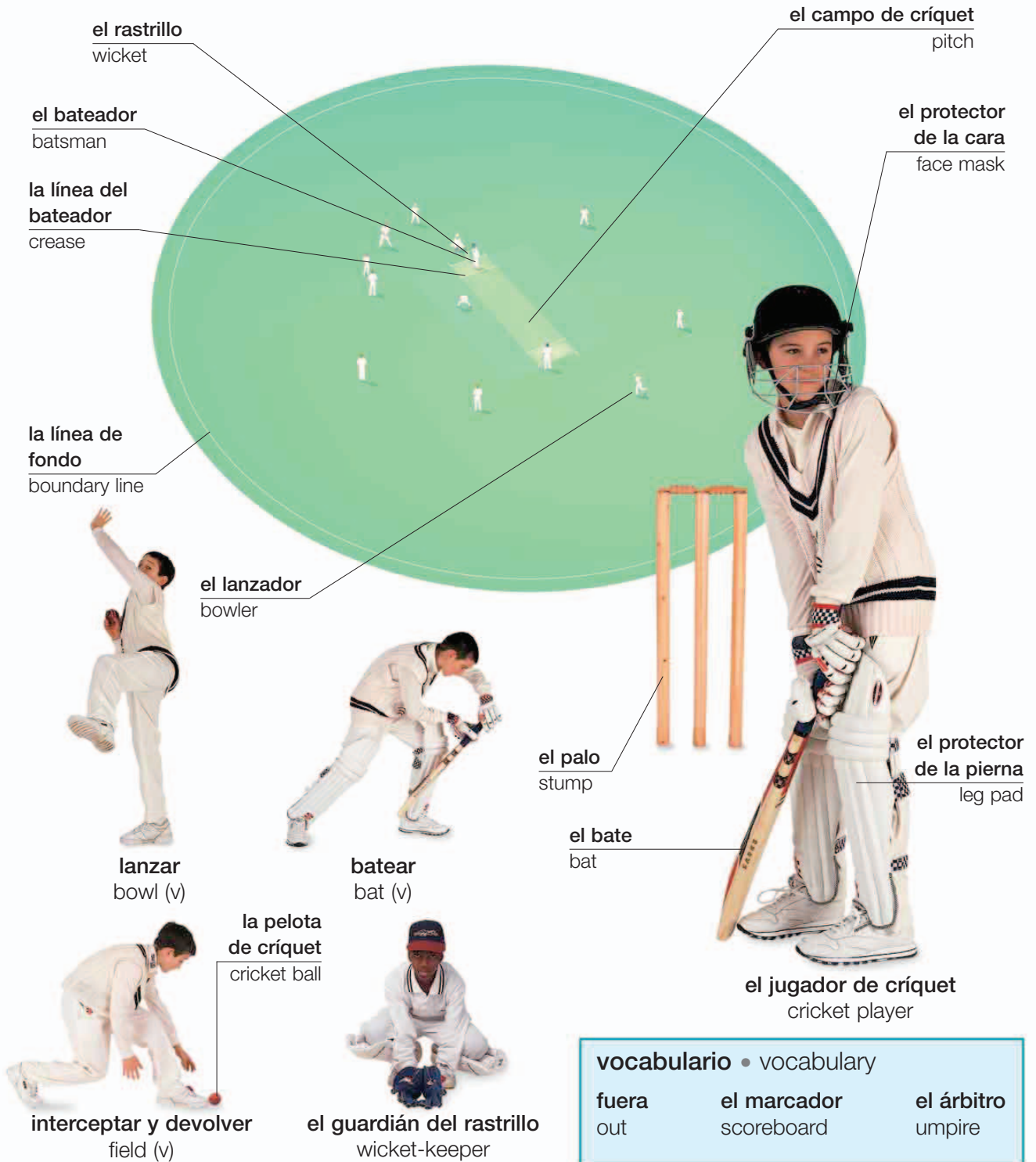

vocabulario • vocabulary		
fuera out	el marcador scoreboard	el árbitro umpire

el baloncesto • basketball

la línea de banda
sideline

el árbitro
referee

el círculo central
center circle

la línea de tiro libre
free-throw line

la línea de fondo
endline



el balón
ball

el jugador de baloncesto | basketball player

el número
number

el tablero
backboard

el aro
hoop

la red
net

la canasta
basket

la cancha
court

la línea central
centerline

la línea de tres puntos
three-point line

vocabulario • vocabulary

el saque de banda
throw-in

el salto entre dos
jump ball

el pase
pass

la falta
foul

el rebote
rebound

fuera de banda
out of bounds

las acciones • actions



lanzar
throw (v)



cachar (coger)
catch (v)



tirar
shoot (v)



saltar
jump (v)



marcar
dunk (v)



marcar
cover (v)



bloquear
block (v)



botar
dribble (v)



el vóleybol (c el balonvolea) • volleyball

bloquear
block (v)

la red
net

recibir
dig (v)

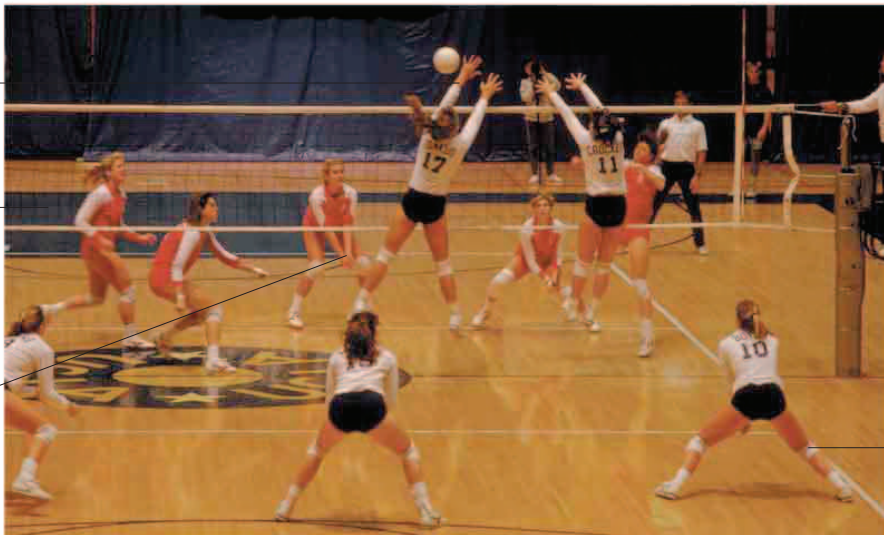

el árbitro
referee

la rodillera
knee support

la cancha | court

el béisbol • baseball

el campo • field

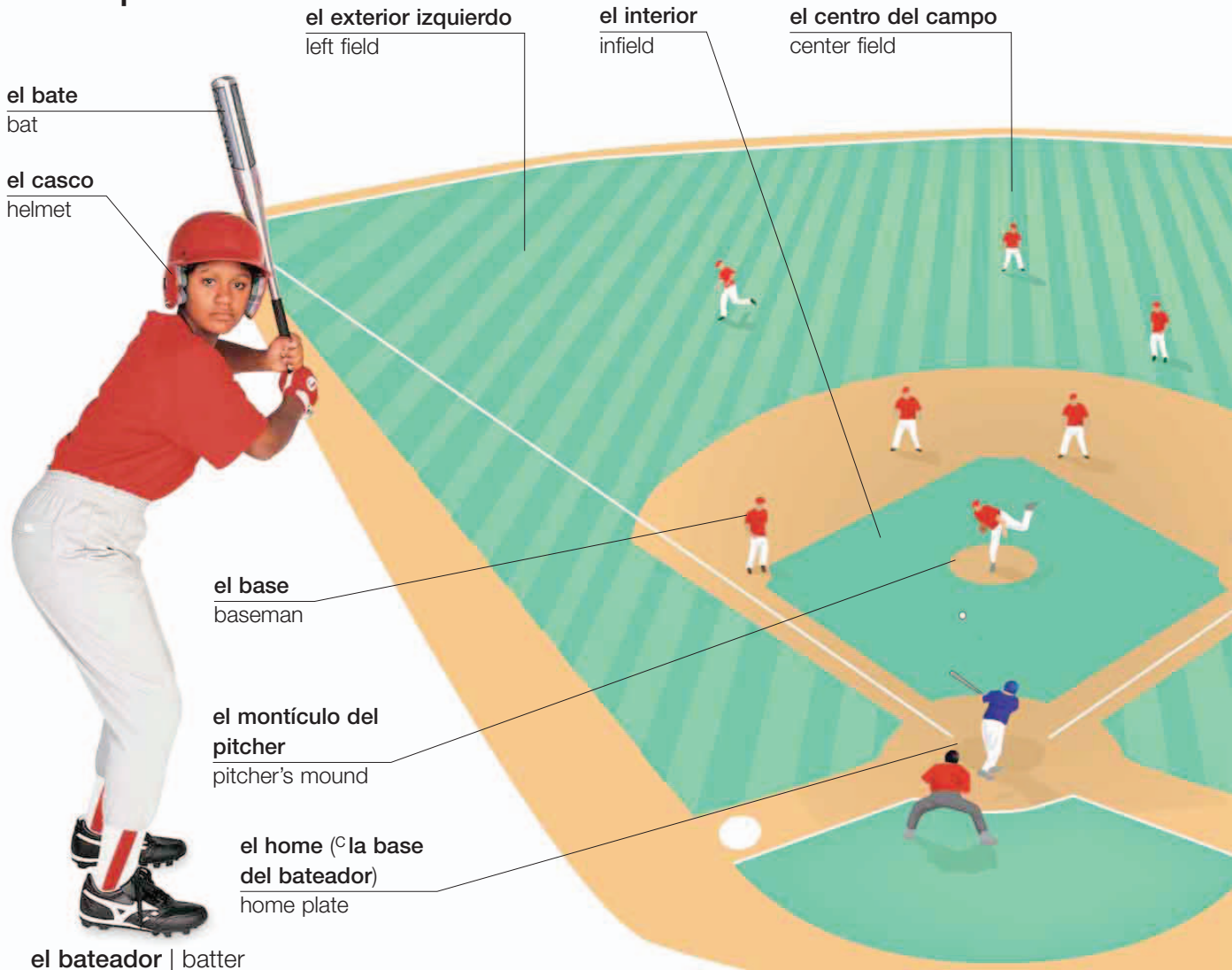

el bateador | batter

vocabulario • vocabulary		
el turno inning	safe (°a salvo) safe	el strike strike
la carrera run	fuera out	el foul (°el fallo) foul



la manopla (°el guante)
glove



la careta (°la máscara)
mask

la bola
(°la pelota)
ball

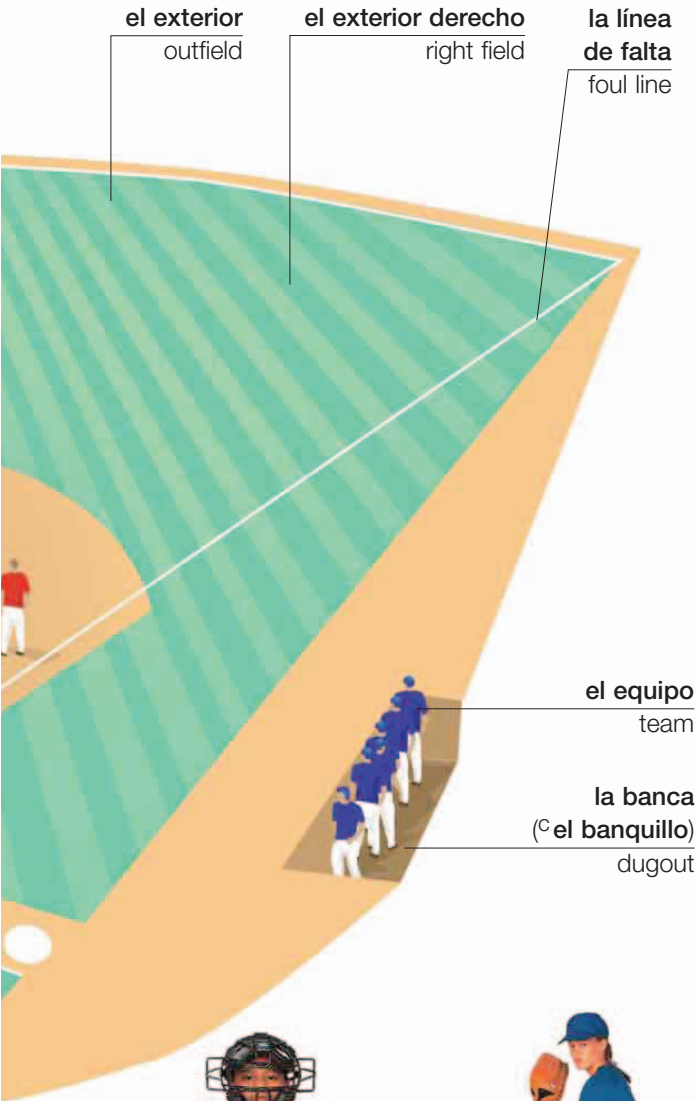

el catcher
catcher



el pitcher
pitcher

las acciones • actions



lanzar | throw (v)



atrapar (^ccoger) | catch (v)



correr
run (v)



defender
field (v)

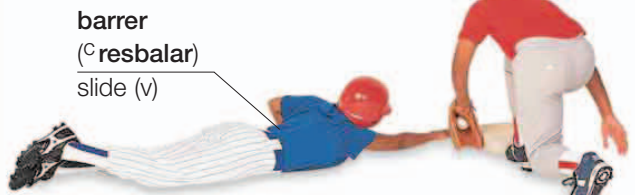

barrer
(^cresbalar)
slide (v)

perseguir
tag (v)

lanzar
pitch (v)



batear
bat (v)

el umpire
(^cel árbitro)
umpire

jugar | play (v)

el tenis • tennis

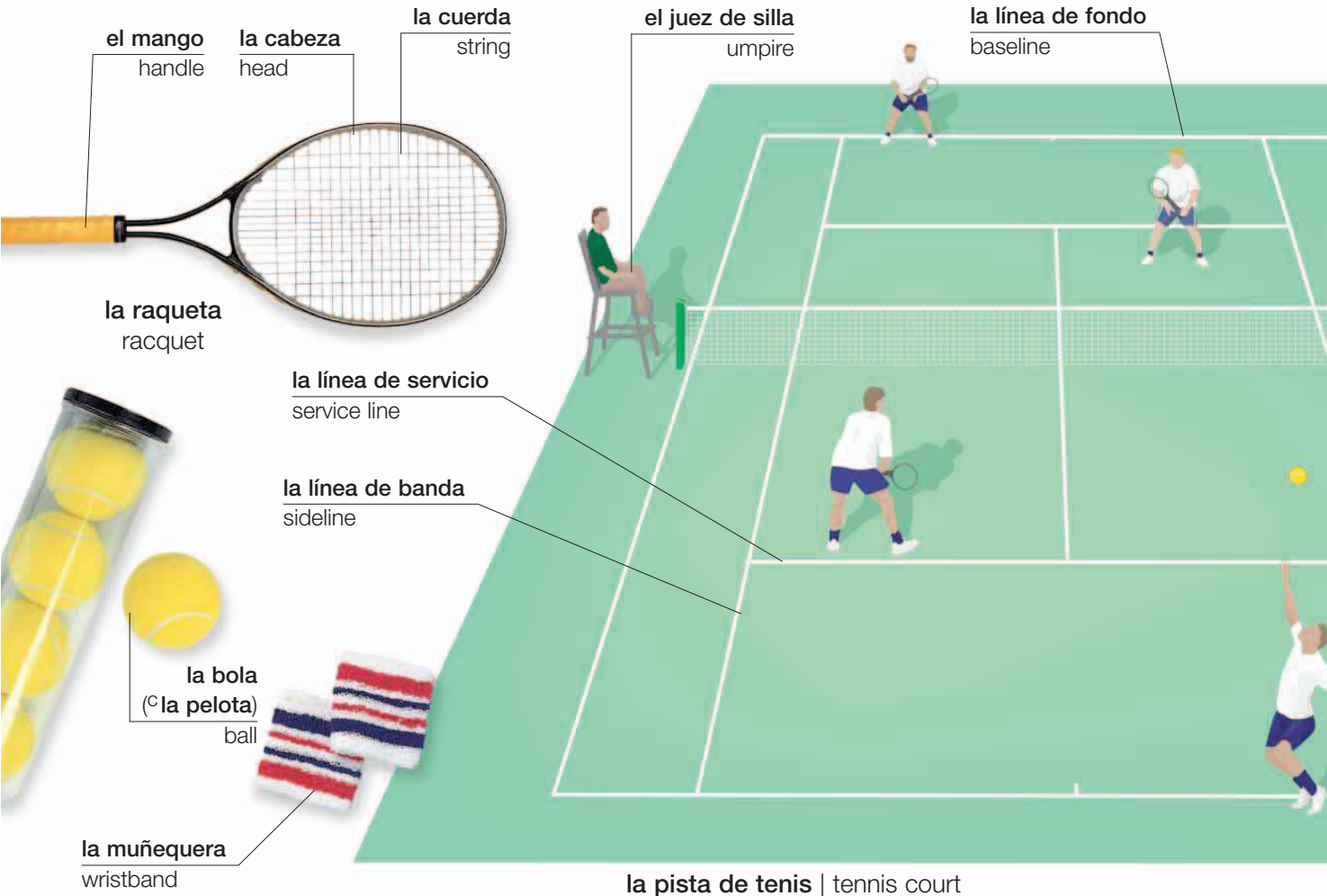

vocabulario • vocabulary

el juego
game

el set
set

nada
love

la falta
fault

el peloteo
rally

el efecto
spin

los dobles
doubles

el partido
match

la ventaja
advantage

el as
ace

¡red!
let!

el juez de línea
linesman

el singles
(^cel individual)
singles

el tiebreak
tiebreaker

cuarenta iguales
deuce

la dejada
dropshot

el tiro con efecto
slice

el campeonato
championship

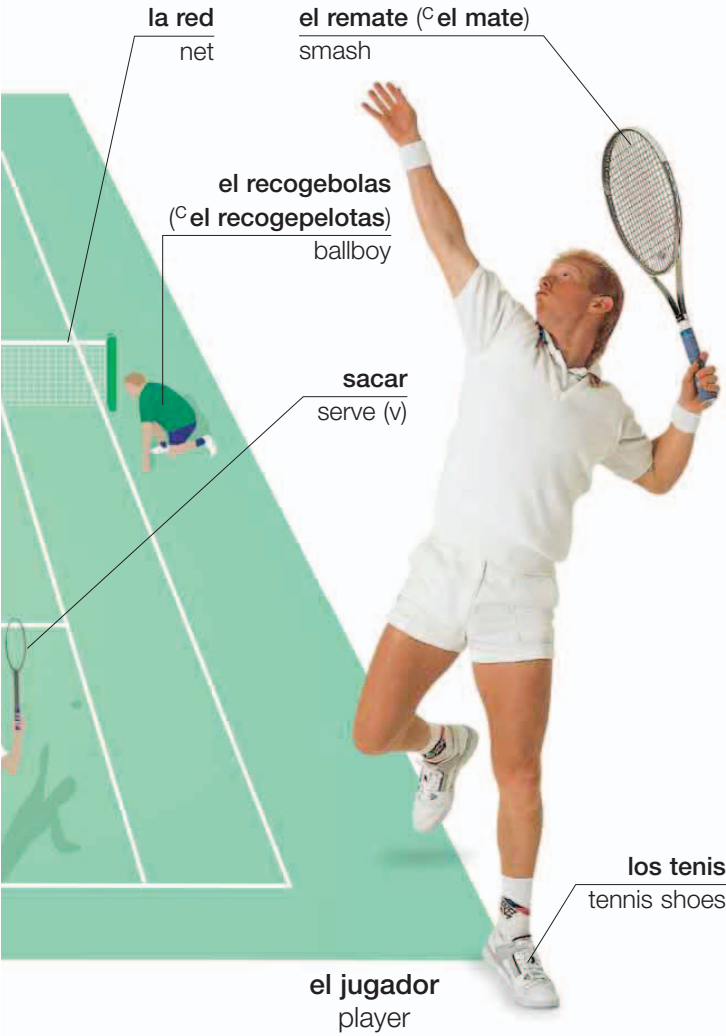

los golpes • strokes



el servicio
serve

la volea
volley



el resto
return



el globo
lob



el derecho
forehand



el revés
backhand

los juegos de raqueta • racquet games



el bádmiton
badminton

el gallo
(c el volante)
shuttlecock



el ping-pong
table tennis

la raqueta
(c la pala)
bat



el squash
squash



el racketball
racquetball

el golf • golf



la bandera
flag

la trampa de arena (el búnker)
bunker

el green
green

la salida
teeing ground

el hoyo
hole

hacer un swing
swing (v)

la calle
fairway

el rough
rough

el estanque
water hazard

el campo de golf
golf course

el carrito (el buggy)
buggy

la postura
stance



la casa club (el club) | clubhouse

la golfista (la jugadora de golf) | golfer

el equipo • equipment



los palos de golf • golf clubs



las acciones • actions



vocabulario • vocabulary

el par par	el sobre par over par	el handicap handicap	el caddy caddy	el golpe stroke	el backswing backswing
el bajo par under par	el hoyo en uno hole in one	el torneo tournament	los espectadores spectators	el swing de práctica practice swing	la línea de juego line of play

el atletismo • track and field

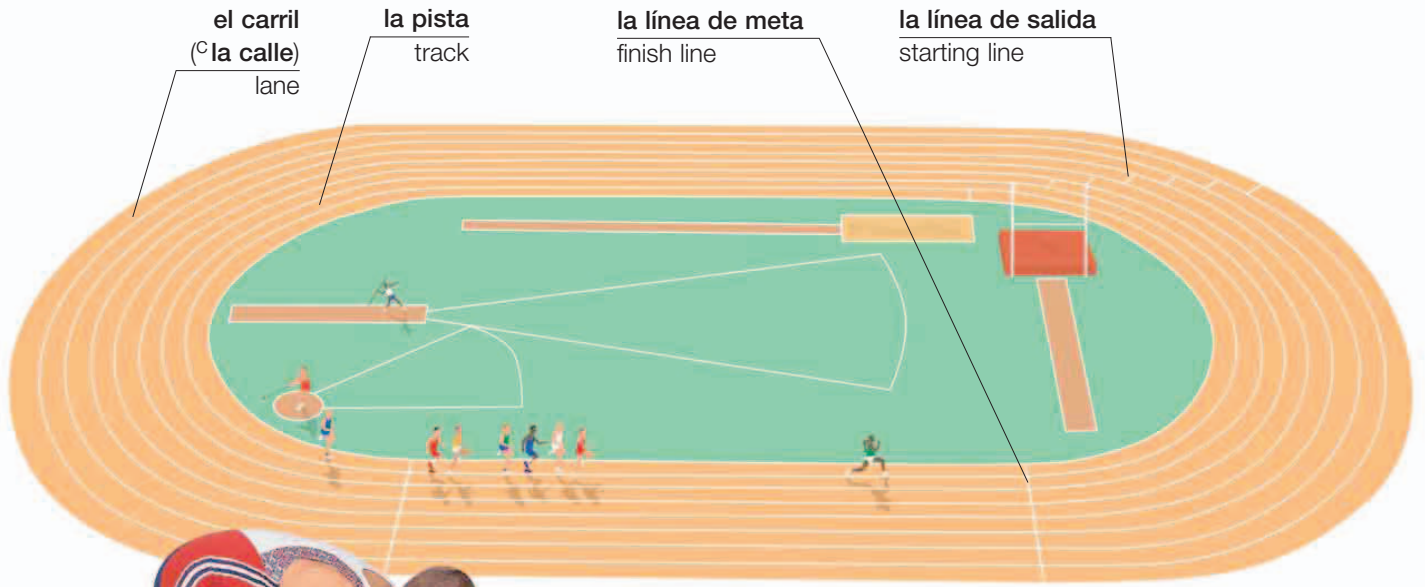

el cajón
de salida
starting
blocks

el esprinter
sprinter



el lanzamiento de disco
discus

el campo
field

la atleta
athlete



el lanzamiento de
bala (^c de peso)
shotput



el lanzamiento de
jabalina
javelin

vocabulario • vocabulary

la carrera
la carrera

el récord
record

la maratón
marathon

el salto con pértiga
pole vault

el tiempo
time

batir un récord
break a record (v)

la foto final
(^c la **fotofinish**)
photo finish

la marca personal
personal best



el cronómetro
stopwatch

el relevo
(^oel testigo)
baton



la carrera de relevos
relay race

la barra
(^oel listón)
bar



el salto de altura
high jump



el salto de longitud
long jump



la carrera de vallas
hurdles

la gimnasia • gymnastics



el caballo
horse

el salto
vault

el trampolín
springboard



el salto mortal
somersault



el tapete
mat

los ejercicios de piso
(^ode suelo)
floor exercises

la gimnasta
gymnast



la viga (^ola barra) de equilibrio
beam



el listón
(^ola cinta)
ribbon

la voltereta
cartwheel

la gimnasia rítmica
rhythmic gymnastics

vocabulario • vocabulary

las barras paralelas
(^olas paralelas)
parallel bars

las barras
asimétricas
asymmetric bars

las argollas
(^olas anillas)
rings

las medallas
medals

la plata
silver

la barra fija
horizontal bar

el caballo con arcos
pommel horse

el podio
podium

el oro
gold

el bronce
bronze

los deportes de combate • combat sports

el adversario
opponent

el protector
guard

el guante
glove

el cinturón
belt



el taekwondo
tae kwon do



el karate
karate



el judo
judo



el aikido
aikido



la espada
sword

el kendo
kendo

la careta
mask



el kung fu
kung fu



el full contact
kickboxing

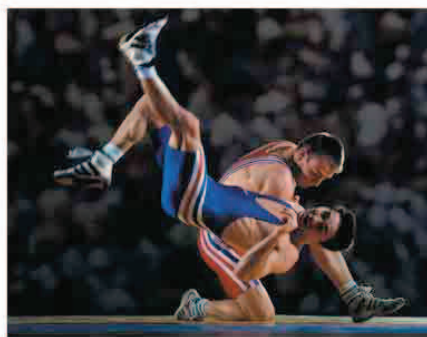

la lucha libre
wrestling



el boxeo
boxing

los movimientos • actions



la caída
fall



el agarre
hold



el derribo
throw



la inmovilización
pin



la patada
kick



el puñetazo
punch



el golpe
strike



el golpe
chop



el salto
jump



el bloqueo (c la parada)
block

vocabulario • vocabulary

el ring
boxing ring

el combate
bout

el puño
fist

el cinturón negro
black belt

la capoeira
capoeira

los guantes de
boxeo
boxing gloves

el round
(c el asalto)
round

el K.O.
knockout

la defensa
personal
self-defense

el sumo
sumo wrestling

el protegredientes
mouth guard

el entrenamiento
sparring

el saco de arena
punching bag

las artes marciales
martial arts

el tai-chi
tai-chi

la natación • swimming

el equipo • equipment



el flotador de brazo
swim band



los goggles (c las gafas de natación)
goggles

la pinza para la nariz
nose clip



la tabla (c el flotador)
kickboard



el traje de baño
swimsuit

el carril (c la calle)
lane

el agua
water

el cajón de salida
starting block



la alberca (c la piscina)
swimming pool

la gorra (c el gorro de baño)
swimming cap



el traje de baño (c el bañador)
trunks

el nadador | swimmer

el trampolín
diving board

el clavadista
diver



tirarse un clavado | dive (v)



nadar | swim (v)



el giro | turn

los estilos • styles



el crol
front crawl



el pecho (°la braza)
breaststroke



el dorso (°la espalda) | backstroke

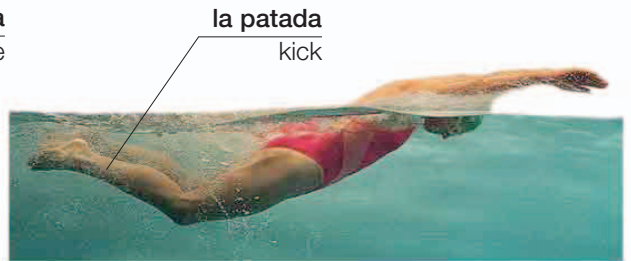

la mariposa | butterfly

el buceo • scuba diving

el traje de buzo
wetsuit

la aleta
flipper

el cinturón de
pesas
weight belt



el tanque (°la
botella de aire)
air cylinder

el visor
(°las gafas)
mask

el regulador
regulator

el tubo
snorkel

vocabulario • vocabulary

el clavado
(°el salto)
dive

hacer agua
tread water (v)

el salvavidas
(°el socorrista)
lifeguard

la zona
profunda
deep end

la zona poco
profunda
shallow end

el calambre
(°el tirón)
cramp

el clavado
(°el salto) alto
high dive

el clavado
(°el salto)
de salida
racing dive

las taquillas
lockers

el waterpolo
water polo

el nado
sincronizado
synchronized swimming

ahogarse
drown (v)

la vela • sailing



la brújula
compass



el ancla
anchor

la
escotera
cleat

la cubierta
sidedeck

el foque
headsail

la proa
bow

la caña
del timón
tiller

el casco
hull

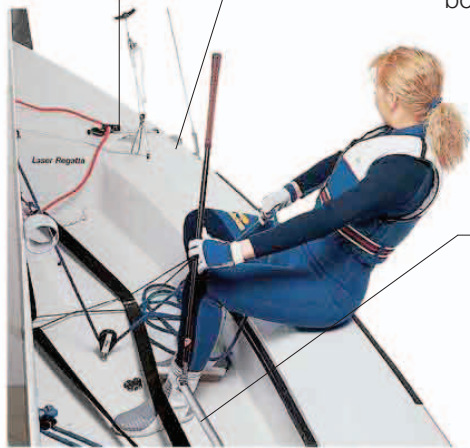

navegar | navigate (v)



el mástil
mast

las jarcias
rigging

la vela mayor
mainsail

la botavara
boom

la popa
stern

el yate | yacht

la seguridad • safety



la bengala
flare



el salvavidas
life preserver



el chaleco salvavidas
life jacket



la balsa salvavidas
life raft

los deportes acuáticos • watersports



el remero
rower

el remo
oar

remar | row (v)



el kayak
kayak

el remo
paddle

el canotaje (c el piragüismo)
kayaking



la vela
sail

el windsurfista
windsurfer

la tabla
board

la cinta para el pie
footstrap

el windsurf | windsurfing



la tabla de surf
surfboard

el surfing
surfing



waterski (c el esquí)
le ski

el esquí acuático
waterskiing



la carrera de lanchas (c de motoras)
speedboating



el rafting
rafting



la moto acuática
jet-skiing

vocabulario • vocabulary

el surfista
surfer

la tripulación
crew

el viento
wind

la rompiente
surf

la escota
sheet

la orza
centerboard

el esquiador acuático
waterskier

virar
tack (v)

la ola
wave

los rápidos
rapids

el timón
rudder

volcar
capsize (v)

la equitación • horseback riding

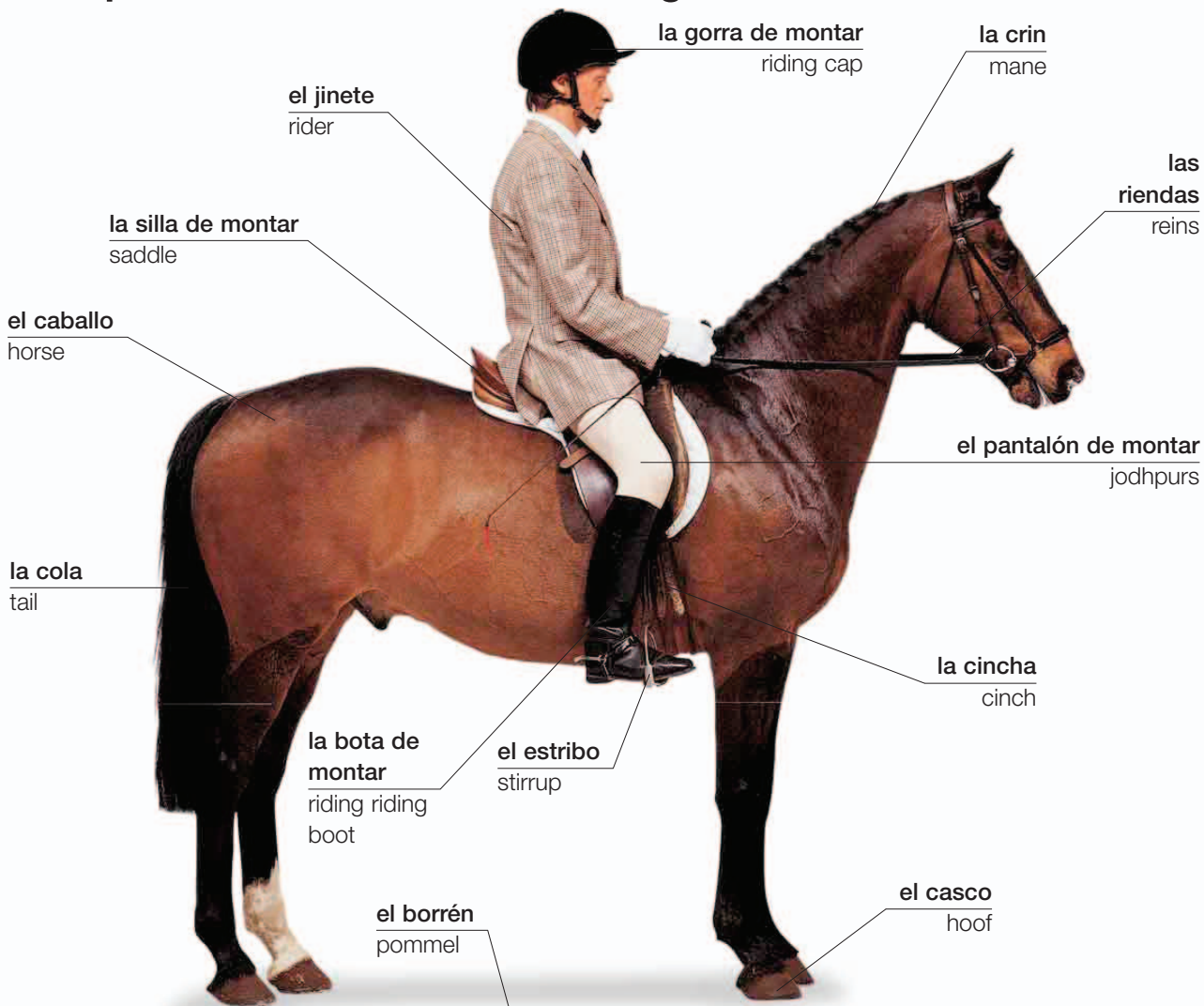

la herradura
horseshoe



la silla
([©]el sillín)
seat

la silla de montar de escaramuza
([©]de señora) | sidesaddle

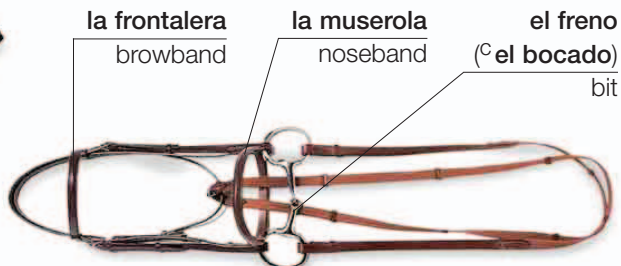

la frontalera
browband

la muserola
noseband

el freno
([©]el bocado)
bit

la brida | bridle

la fusta | riding crop

las modalidades • events

el caballo de carreras
racehorse



la carrera de caballos
horse race

la valla
fence



la carrera de obstáculos
steeplechase



la carrera al trote
harness race



el rodeo
rodeo



el concurso de saltos
show jumping



la carrera de carrozas
carriage race



el paseo
trekking



la doma y monta
dressage



el polo
polo

vocabulario • vocabulary

el paso
walk

el medio galope
canter

el salto
jump

el cabestro
halter

el cercado
paddock

el hipódromo
racecourse

el trote
trot

el galope
gallop

el mozo de cuadra
groom

la cuadra
stable

el ruedo
arena

la carrera sin
obstáculos
flat race

la pesca • fishing



el plomo | sinker

la punta
(C la lengüeta)
barb



el anzuelo
fishhook

el ojo
eye



el cebo | bait



el flotador
float



el señuelo
lure



la mosca
fly



la red para recoger
landing net



la caja de aparejos
tackle box



la red para las capturas
keep net

el sedal
line

la caña de pescar
fishing rod

el carrete
reel

las botas al-
tas de goma
waders



el pescador de caña | fisherman

los tipos de pesca • types of fishing



la pesca en agua dulce
freshwater fishing



la pesca con mosca
fly fishing

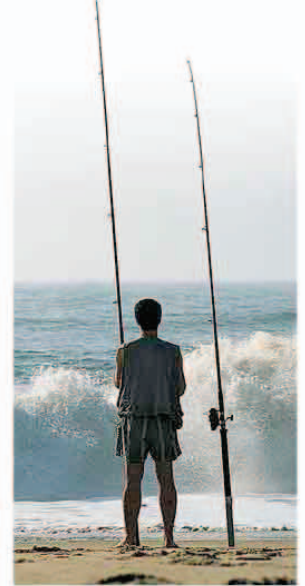

la pesca en la orilla
surfcasting



la pesca deportiva
sport fishing



la pesca de altura
deep sea fishing

las acciones • activities

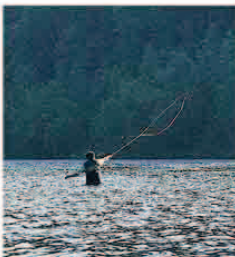

lanzar
cast (v)

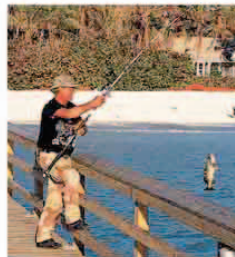

atrapar (coger)
catch (v)



recoger
reel in (v)



**atrapar (coger)
con la red**
net (v)



soltar
release (v)

vocabulario • vocabulary

cebar
bait (v)

los aparejos
tackle

la ropa impermeable
rain clothes

la licencia de pesca
fishing license

la nasa
creel

picar
bite (v)

el carrete
spool

la pértiga
pole

la pesca en alta mar
marine fishing

la pesca con arpón
spearfishing

el esquí • skiing

la pista
ski slope

la telesilla
chairlift

la góndola
(^c el teleférico)
cable car



el guante
glove

la pista de esquí
ski run

el bastón
ski pole

la barrera de
seguridad
safety barrier

la punta
tip

el canto
edge

el esquí
ski

la chaqueta de
esquí
ski jacket



la esquiadora
skier

la bota de esquí
ski boot

las modalidades • events



el descenso
downhill skiing



el poste
gate

el slálm
slalom



el salto
ski jump



el esquí de fondo
cross-country skiing

los deportes de invierno • winter sports



la escalada en hielo
ice climbing



el patinaje sobre hielo
ice skating



el patinaje artístico
figure skating

los goggles
(C las gafas)
goggles



el snowboarding
snowboarding



el bobsleigh
bobsled



el luge
luge



la moto de nieve
snowmobile



tirarse en trineo
sledding

vocabulario • vocabulary

el esquí alpino
alpine skiing

el trineo con perros
dogsledding

el slálm gigante
giant slalom

el biatlón
biathlon

fuera de pista
off-piste

la avalancha
avalanche

el curling
curling

el patinaje de velocidad
speed skating

los otros deportes • other sports

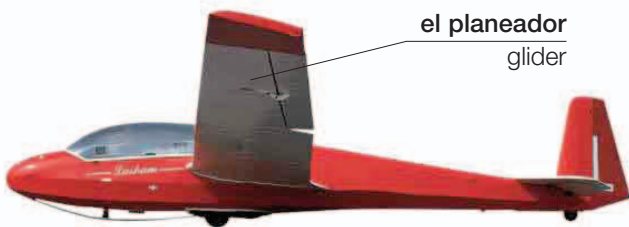

el planeador
glider

el ala delta
hang-glider



el vuelo con ala delta
hang-glider

el vuelo sin motor
gliding



la cuerda
rope

la escalada
rock climbing



el paracaídas
parachute

el paracaidismo
parachuting



el parapente
parasailing



el paracaidismo en caída libre
skydiving



el rappel
abseiling

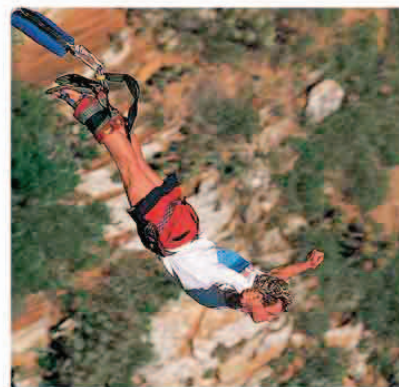

el salto bungee (© el puenting)
bungee jumping



el rally
rally driving



el piloto de carreras
race-car driver

el automovilismo
auto racing



el motocross
motocross



el motociclismo
motorbike racing



la patineta
([©]el monopatín)
skateboard

andar en patineta
([©]montar en monopatín)
skateboarding



el patinaje en línea
inline skating



el palo
stick

el lacrosse
lacrosse

la máscara
mask

el florete
foil



el esgrima
fencing

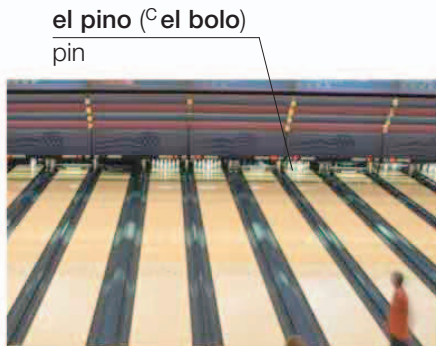

el pino ([©]el bolo)
pin

la flecha
arrow

el carcaj
quiver

el arco
bow



el tiro con arco
archery

la diana
target



el tiro
target shooting



la bola de boliche
([©]de bowling)
bowling ball

el boliche ([©]los bolos)
bowling



el pool ([©]el billar americano) | pool



el billar
snooker

la forma física • fitness

la bicicleta
exercise bike

la máquina de ejercicios
gym machine

el banco
bench

las pesas
free weights

la barra
bar

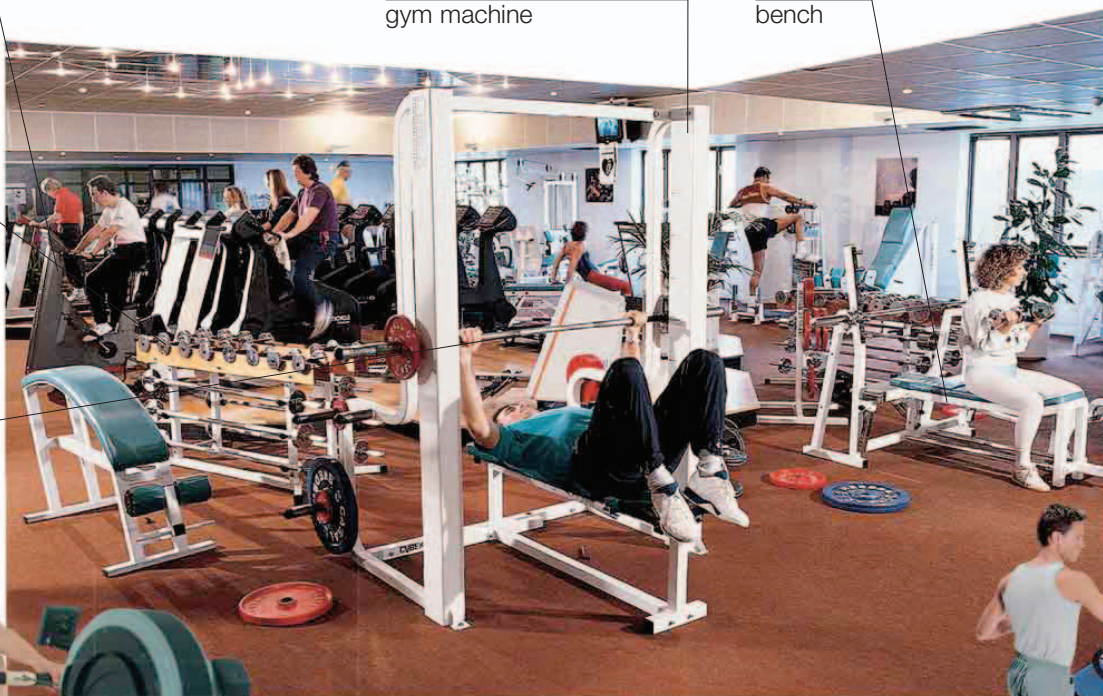

el gimnasio
gym



la banda caminadora
treadmill



la máquina de cross
elliptical trainer

la máquina de
remos
rowing machine



la máquina
de step
step machine



la alberca
(^c la piscina)
swimming pool



la entrenadora
personal
personal trainer



el sauna
sauna

los ejercicios • exercises



el estiramiento
stretch



la flexión con
estiramiento
lunge

los leotardos
tights



la flexión
push-up



ponerse en cuclillas
squat



el abdominal
sit-up

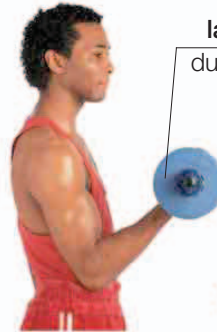

el ejercicio de
bíceps
bicep curl

la pesa
dumbbell



los ejercicios de piernas
leg press



los ejercicios
pectorales
chest press



el levantamiento
de pesas
weight training

la barra de
pesas
weight bar



el jogging
(^cel footing)
jogging

las
zapatillas
running
shoes



el pilates
pilates

vocabulario • vocabulary

entrenar
train (v)

correr en parada
jog in place (v)

estirar
extend (v)

la gimnasia
prepugilística
boxercise

saltar a la comba
jumping rope

calentar
warm up (v)

flexionar
flex (v)

levantar
pull up (v)

la tabla de
gimnasia
circuit training



el ocio
leisure

el teatro • theater



el telón
curtain

los bastidores
wings

la escenografía
(^cel decorado)
set

el público
audience

la orquesta
orchestra

el escenario | stage

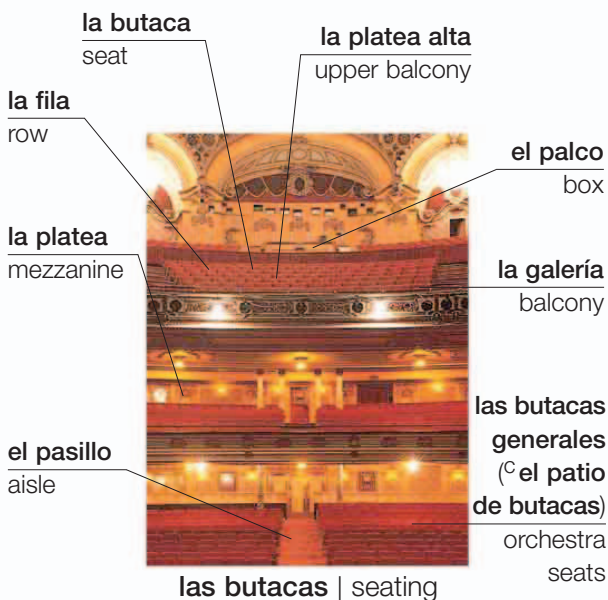

la butaca
seat

la platea alta
upper balcony

la fila
row

el palco
box

la platea
mezzanine

la galería
balcony

el pasillo
aisle

las butacas
generales
(^cel patio
de butacas)
orchestra
seats

las butacas | seating

vocabulario • vocabulary

la obra
play

el director
director

el estreno
opening night

el reparto
cast

el productor
producer

el programa
program

el actor
actor

el guión
script

el foso de la
orquesta
orchestra pit

la actriz
actress

el telón de
fondo
backdrop

el entreacto
(^cel descanso)
intermission



el concierto
concert



el musical
musical

el vestuario
(^c el traje)
costume



el ballet
ballet



la ópera
opera

vocabulario • vocabulary

el acomodador
usher

la banda sonora
soundtrack

Quisiera dos entradas para la sesión de esta noche.
I'd like two tickets for tonight's performance.

la música clásica
classical music

aplaudir
applaud (v)

¿A qué hora empieza?
What time does it start?

la partitura
musical score

el bis
encore

el cine • movies

las palomitas
popcorn

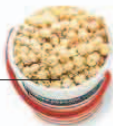

el vestíbulo
lobby

la taquilla
box office

el póster
poster



el cine
movie theater



la pantalla
screen

vocabulario • vocabulary

la comedia
comedy

la película romántica
romance

la película de suspense
thriller

la película de ciencia ficción
science fiction movie

la película de miedo
horror movie

la película de aventuras
adventure

la película de vaqueros (^c del oeste)
Western

la película de dibujos animados
animated movie

la orquesta • orchestra

la cuerda • strings



el piano | piano

la partitura
score

la clave de fa
bass clef

la clave de sol
treble clef

la nota
note

el pentagrama
staff

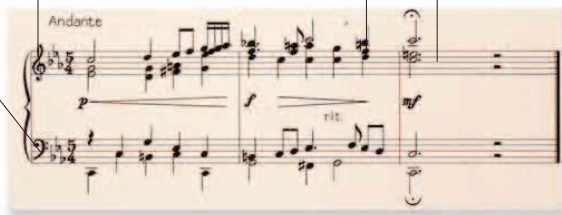

la notación | notation

vocabulario • vocabulary

la obertura
overture

la sonata
sonata

la pausa
rest

sostenido
sharp

natural
natural

la escala
scale

la sinfonía
symphony

los
instrumentos
instruments

el tono
pitch

bemol
flat

la barra
bar

la batura
baton

el viento-madera • woodwind



el flautín
piccolo



la flauta
flute



el oboe
oboe



el corno inglés
English horn



el saxofón
saxophone



el clarinete
clarinet



el clarinete bajo
bass clarinet



el fagote
bassoon



el contrafagote
double bassoon

la percusión • percussion



el timbal
kettledrum



el gong
gong

el vibráfono
vibraphone



el pedal
foot pedal



los bongos
bongos



el tambor pequeño
snare drum



los platillos
cymbals



el pandero
([©]la pandereta)
tambourine



el triángulo
triangle



las maracas
maracas

el viento-metal • brass



la trompeta
trumpet



el trombón de varas
trombone



el corno de caza
French horn



la tuba
tuba

el concierto • concert



el concierto de rock | rock concert

los instrumentos • instruments

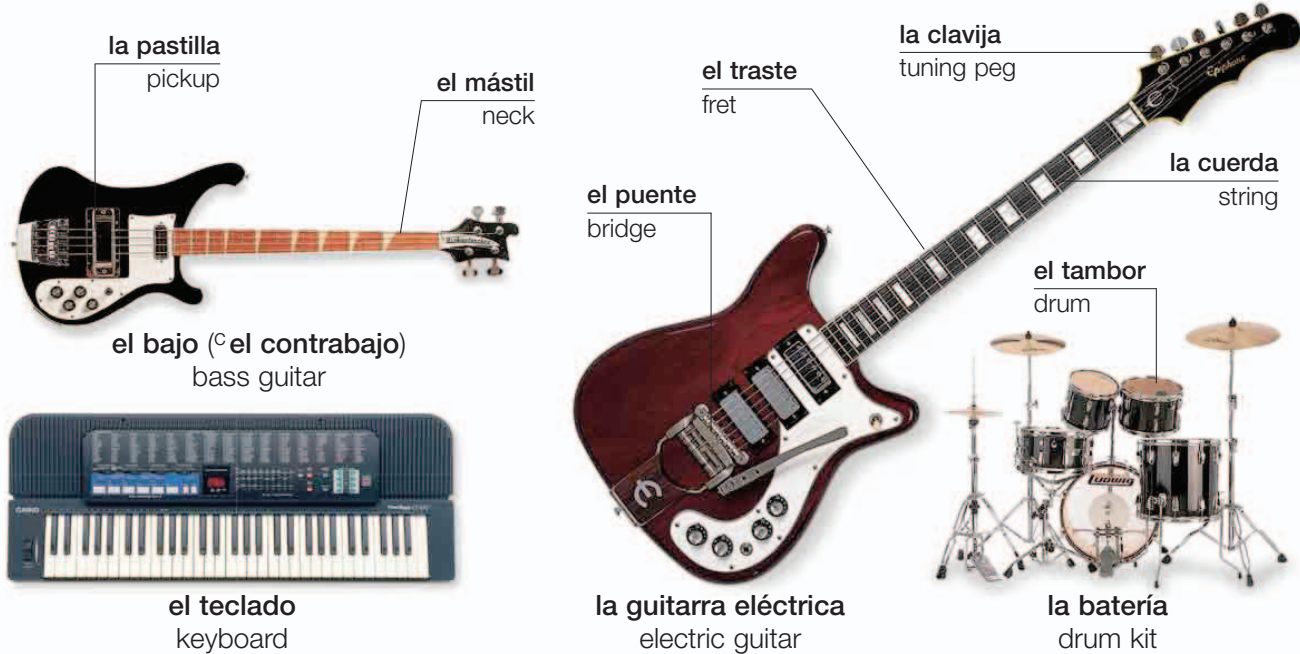

los estilos musicales • musical styles



el jazz
jazz



el blues
blues



el punk
punk



la música folklórica (°folk)
folk music



el pop
pop



la música de baile
dance



el rap
rap



el heavy metal
heavy metal



la música clásica
classical music

vocabulario • vocabulary

la canción	la letra	la melodía	el ritmo	el reggae	la música country	el reflector (°el foco)
song	lyrics	melody	beat	reggae	country	spotlight

el turismo • sightseeing



el turista
tourist

la atracción turística | tourist attraction



el itinerario
itinerary

descubierto
open-top

el autobús turístico | tour bus

la guía turística
tour guide



la visita guiada
([©] la visita con guía)
guided tour

la estatuilla
figurine



los recuerdos
souvenirs

vocabulario • vocabulary

el precio de entrada
admission
charge

la guía del viajero
guidebook

la película
film

la izquierda
left

¿Dónde está...?
Where is...?

abierto
open

la cámara de vídeo
camcorder

la cámara ([©] la máquina) fotográfica
camera

la derecha
right

Estoy perdido.
([©] Me he perdido.)
I'm lost.

cerrado
closed

las pilas
batteries

las indicaciones
directions

recto
straight
ahead

¿Podría decirme cómo se va a...?
Can you tell me the way to...?

los lugares de interés • attractions

el cuadro
painting

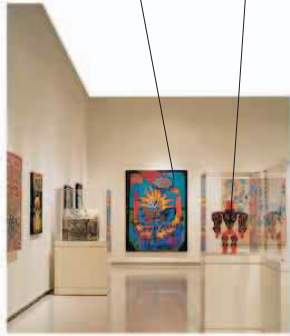

la galería de arte
(el museo de arte)
art gallery

la muestra
exhibit



el monumento
monument

la exposición
exhibition



el museo
museum

la ruina famosa
famous ruin



el edificio
histórico
historic building



el casino
casino



los jardines
garden



el parque nacional
national park

la información • information

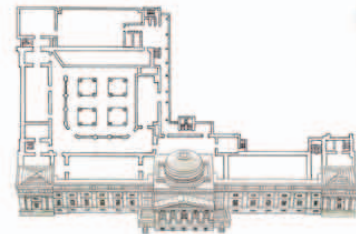

el plano de la planta
floor plan



el mapa (el plano)
map

las horas
times



el horario
timetable



la oficina de
información
tourist information

las actividades al aire libre • outdoor activities

el sendero
footpath

el reloj de sol
sundial

la cafetería
café



el parque | park

la montaña rusa
roller coaster



la feria
fair



el parque de diversiones
([©] el parque de atracciones)
amusement park

el pasto
([©] la hierba)
grass

la banca
([©] el banco)
bench

los jardines
clásicos
formal gardens



el safari park
wildlife park



el zoológico ([©] el zoo)
zoo

las actividades • activities



el ciclismo
cycling



el jogging
jogging



la patineta
(^omontar en patinete)
skateboarding



el patinaje
rollerblading

el sendero para caballos
riding trail



la ornitología
bird watching



la equitación
horseback riding



la caminata
(^oel senderismo)
hiking

la canasta
(^ola cesta)
hamper



el picnic
picnic

el área de juegos • playground



el cajón de arena
sandbox



la alberca (^ola piscina)
de plástico
wading pool



los columpios
swing



el subibaja | seesaw



la resbaladilla (^oel tobogán)
slide



el changuero
(^ola estructura para escalar)
climber

la playa • beach

el hotel
hotel

la sombrilla
beach umbrella

la caseta
beach hut

la arena
sand

la ola
wave

el mar
sea



la bolsa de playa
beach bag

el bikini
bikini



asolear (°tomar el sol) | sunbathe (v)

el salvavidas
(^oel socorrista)
lifeguard



la torre de vigilancia
lifeguard tower



la barrera contra el viento
windbreak



el paseo marítimo
promenade



el asoleadero (^ola hamaca)
deck chair



los lentes oscuros
(^olas gafas de sol)
sunglasses



el sombrero para el sol
sunhat



el bronceador
(^ola crema bronceadora)
suntan lotion



la crema protector
(^ola crema protectora)
sunblock



la pelota de playa
beach ball



la llanta (^oel flotador)
rubber ring

el traje de baño
(^oel bañador)
swimsuit

la pala
shovel

la cubeta
(^oel cubo)
pail

el castillo de arena
sandcastle



la toalla de playa
beach towel

la concha
shell



el camping • camping



los baños
(^clos aseos)
restrooms

el contenedor
de la basura
waste disposal

las regaderas
(^clas duchas)
showers

el punto eléctrico
electric hook-up

el toldo
flysheet

la estaca
(^cla clavija)
tent peg

la cuerda
guy rope

la roulotte
camper

el camping
campsite

vocabulario • vocabulary

acampar
camp (v)

el lugar (^cla plaza)
site

la mesa de picnic
picnic bench

el carbón vegetal
charcoal

la oficina del director
manager's office

el catre de campaña
cot

la hamaca
hammock

la hoguera
campfire

hay lugares (^cplazas)
libres
sites available

poner (^cmontar)
una tienda
pitch a tent (v)

el cámper
camper van

la pastilla para fogatas
firelighter

lleno (^ccompleto)
full

el tubo (^cel palo) **de la tienda**
tent pole

el remolque
trailer

encender una fogata
light a fire (v)



el repelente de insectos
insect repellent



la linterna
flashlight

el mosquitero
mosquito net



la ropa térmica
(^o termoaislante)
thermal underwear



las botas de trekking
hiking boots



la manga
(^o la ropa impermeable)
rain clothes



el saco de dormir
sleeping bag



la estufilla (^o el hornillo)
camp stove



la parrilla (^o la barbacoa)
grill

la esterilla
sleeping mat



la colchoneta | air mattress

el entretenimiento (° el ocio) en el hogar • home entertainment



la radio digital
digital radio



el iPod®
iPod

el disco de DVD
DVD



el reproductor de DVD
DVD player

el tocadiscos
record player



el lector de discos compactos
CD player

la radio
radio

el amplificador
amplifier

los audífonos
(° los auriculares)
headphones

el mueble
stereo rack

el equipo de alta fidelidad
stereo system



la bocina
(° el altavoz)
speaker

el pie de la bocina
(° el pie del altavoz)
speaker stand



el sintonizador digital
DTV converter box



la pantalla
screen

la cámara de vídeo
camcorder

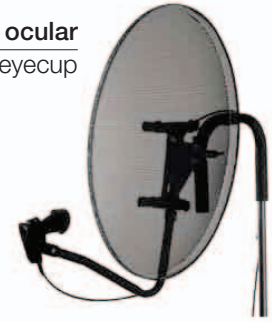

el borde del ocular
eyecup

la antena parabólica
satellite dish



el televisor de pantalla plana
flatscreen TV



la consola
console

el videojuego | video game

los controles
controller



el avance rápido
fast-forward

la pausa
pause

el botón para grabar
record

el volumen
volume

el botón para rebobinar
rewind

el play
play

el stop
stop

el control remoto (el mando a distancia)
remote control



vocabulario • vocabulary

el disco compacto
CD

estéreo
stereo

la casetera (el magnetofón)
cassette player

el WIFI
wifi

ver la televisión
watch television (v)

el casete
cassette tape

el anuncio
advertisement

la televisión por cable
cable television

la película (el largometraje)
feature film

apagar la televisión
turn off the television (v)

el programa
programme

la transmisión por secuencias
streaming

el canal de pago por evento
pay-per-view channel

cambiar de canal
change channels (v)

sintonizar la radio
tune the radio (v)

digital
digital

alta definición
high-definition

encender la televisión
turn on the television (v)

la fotografía • photography

el disparador
shutter release

el obturador
(^o la rueda del diafragma)
aperture dial

el lente
(^o el objetivo)
lens



la cámara réflex | SLR camera



el filtro
filter



la tapa del lente
(^o objetivo)
lens cap



el tripié (^o el trípode)
tripod



el flash electrónico
flash gun



el fotómetro
light meter



el zoom (^o el teleobjetivo)
zoom lens

los tipos de cámara • types of camera



la cámara Polaroid
polaroid camera



la cámara APS
APS camera

el flash
flash



el teléfono con cámara
cameraphone



la cámara desechable
disposable camera

fotografiar • photograph (v)



el carrete
film spool



enfocar
focus (v)



revelar
develop (v)



el negativo
negative

la película
(^c la película)
film

apaisado
landscape

en formato vertical
portrait



la fotografía | photograph



el álbum de fotos
photo album



el portarretratos
picture frame

los problemas • problems

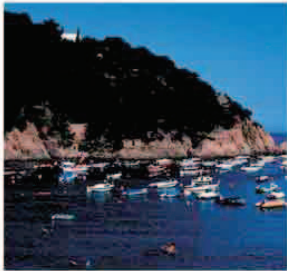

subexpuesto
underexposed



sobreexpuesto
overexposed



desenfocado
out of focus



los ojos rojos
red eye

vocabulario • vocabulary

el visor
viewfinder

la foto (revelada)
print

la funda de la cámara
camera case

mate
mat

la exposición
exposure

con brillo
gloss

el cuarto oscuro
darkroom

la ampliación
enlargement

Me gustaría revelar este rollo.
I'd like this film processed

los juegos • games



la casilla
square

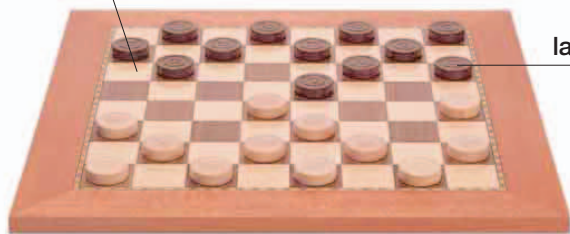

la ficha
piece

las damas
checkers

el ajedrez
chess



la ficha
tile

el scrabble
scrabble

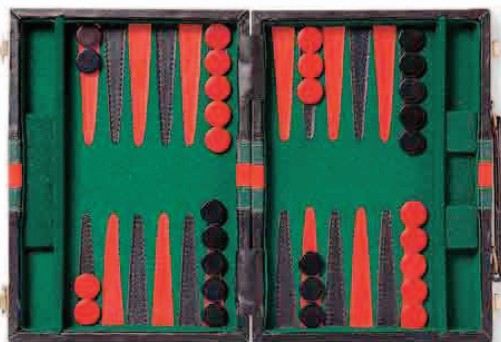

el backgammon | backgammon

el dado
dice

la ficha
counter



el monopolio
monopoly

los juegos de mesa | board games



la filatelia
stamp collecting



el rompecabezas (el puzzle)
jigsaw puzzle

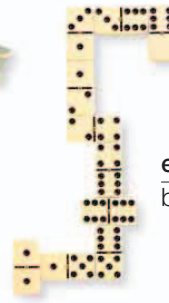

el dominó
dominoes

la diana
dartboard

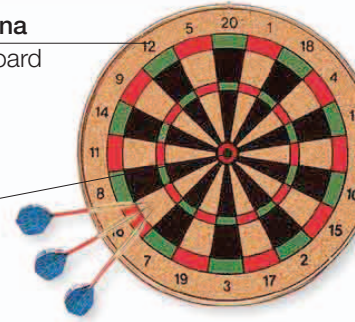

el blanco
bullseye

los dardos
darts

el comodín
joker

el joto (la jota)
jack

la reina
queen

el rey
king

el as
ace



las cartas
cards

el diamante (el rombo)
diamond

la espada (la pica)
spade

el corazón
heart

el trébol
club



barajar | shuffle (v)



repartir (dar) | deal (v)

vocabulario • vocabulary

el turno
move

ganar
win (v)

el perdedor
loser

el punto
point

el bridge
bridge

¿A quién le toca?
Whose turn is it?

jugar
play (v)

el ganador
winner

la partida
game

la puntuación
score

la baraja
deck of cards

Te toca a ti.
It's your move.

el jugador
player

perder
lose (v)

la apuesta
bet

el póquer
poker

el palo
suit

Tira los dados.
Roll the dice.

las manualidades 1 • arts and crafts 1

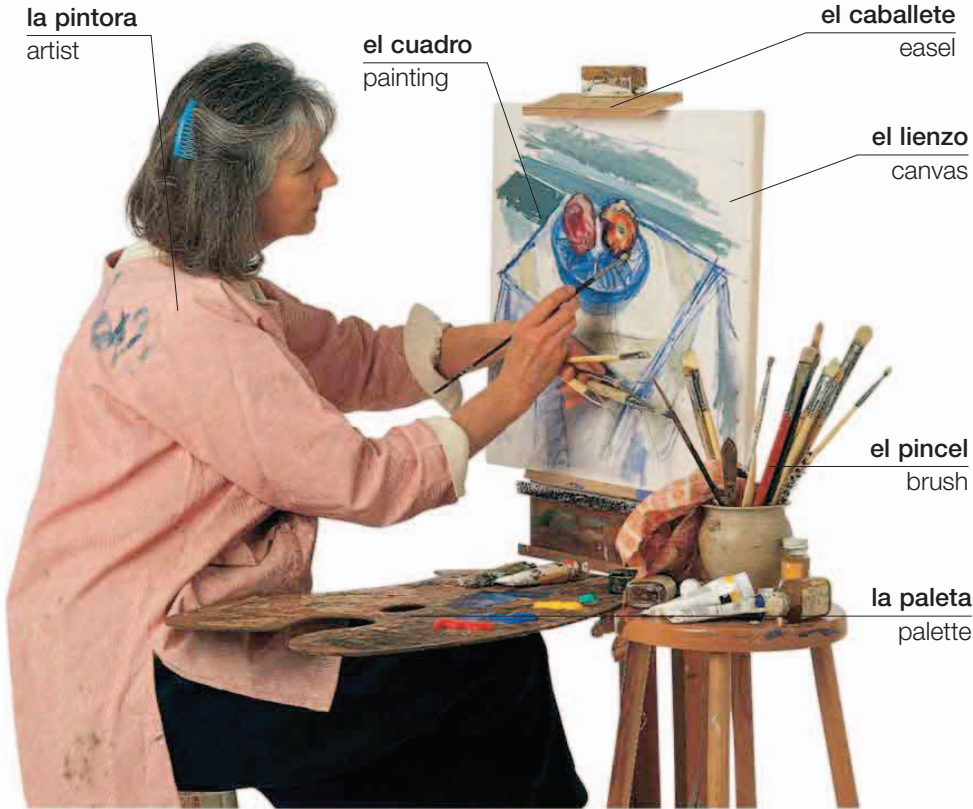

la pintura | painting

las pinturas • paints



las pinturas al óleo
oil paints



las acuarelas
watercolors



los pasteles
pastels



la pintura acrílica
acrylic paint



la t mpera
poster paint

los colores • colors

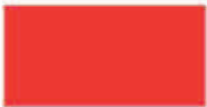

rojo
red



azul
blue



amarillo
yellow



verde
green



naranja
orange



morado
purple



blanco
white



negro
black

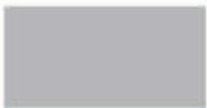

gris
grey



rosa
pink



marr n
brown



azul a il
indigo

las otras manualidades • other crafts



el bloc de dibujo
sketchbook

el lápiz
pencil

el boceto
sketch

la tinta
ink

el carboncillo
charcoal

el dibujo | drawing



la impresión
printing



el grabado
engraving



la piedra
stone

el mazo
mallet

el cincel
chisel

la escultura
sculpting



la madera
wood

la talla en madera
woodworking



la herramienta para modelar
modeling tool

el torno de alfarero
potter's wheel

la arcilla
clay

la cerámica
pottery



el pegamento
([©] la cola)
glue

la cartulina
cardboard

el collage | collage



la orfebrería
jewelry making



el papel maché
papier-mâché



la papiroflexia
origami



el modelismo
model-making

las manualidades 2 • arts and crafts 2



la máquina de coser | sewing machine





ensartar (• **enhebrar**)
thread (v)



coser
sew (v)



zurcir
darn (v)



hilvanar
tack (v)



cortar
cut (v)



el bordado en cañamazo
needlepoint



el bordado
embroidery

la aguja de ganchillo
crochet hook



el ganchillo
crochet



el macramé
macramé



la labor de retales
patchwork



el acolchado
quilting



la labor de encaje
lace-making



tejer
weaving



la aguja de tejer
knitting needle

la labor de punto | knitting



la lana
yarn

la madeja | skein

vocabulario • vocabulary

descoser
unpick (v)

el nailon
nylon

la tela
fabric

la seda
silk

el algodón
cotton

el diseñador
designer

el lino
linen

la moda
fashion

el poliéster
polyester

la cremallera
zipper





el medio ambiente
environment



el espacio • space

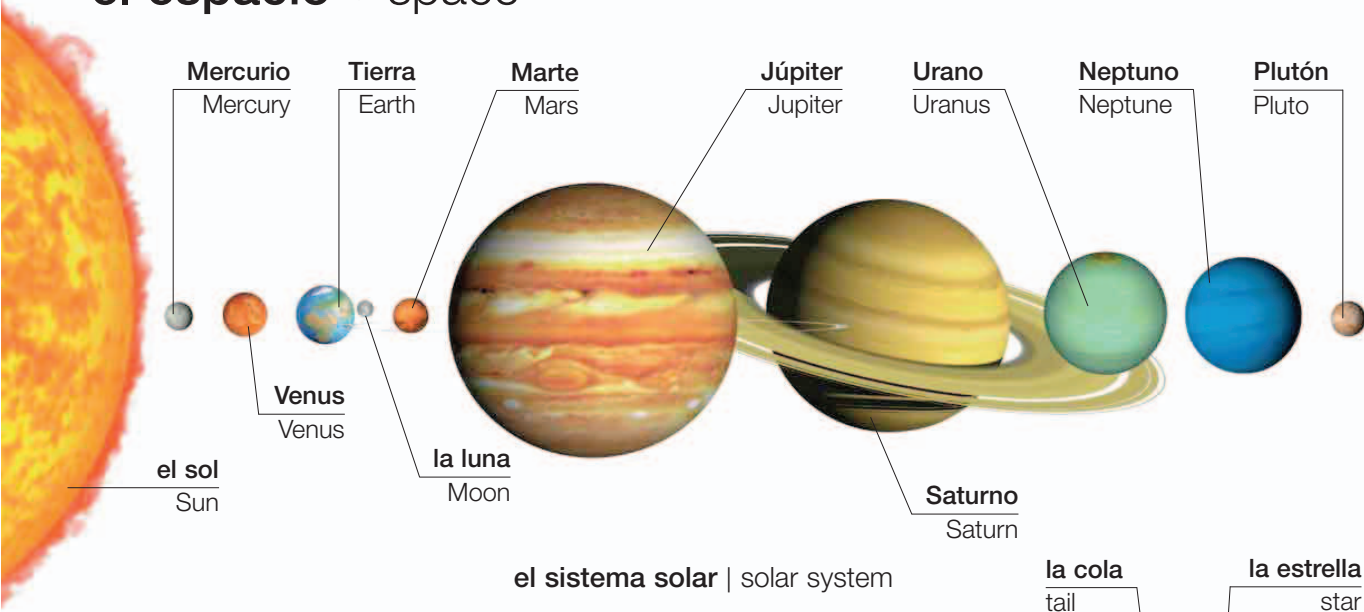

la galaxia
galaxy



la nebulosa
nebula



el asteroide
asteroid

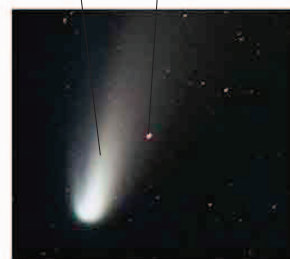

el cometa
comet

vocabulario • vocabulary

el universo
universe

el agujero
negro
black hole

la luna llena
full moon

la órbita
orbit

el planeta
planet

la luna nueva
new moon

la gravedad
gravity

el meteorito
meteor

la media luna
crescent moon



el eclipse | eclipse

la exploración espacial • space exploration

el transbordador espacial
space shuttle

el lanzacohetes
booster



el lanzamiento
launch

el propulsor
thruster

el radar
radar

la escotilla
crew hatch

el traje espacial
space suit



el astronauta | astronaut

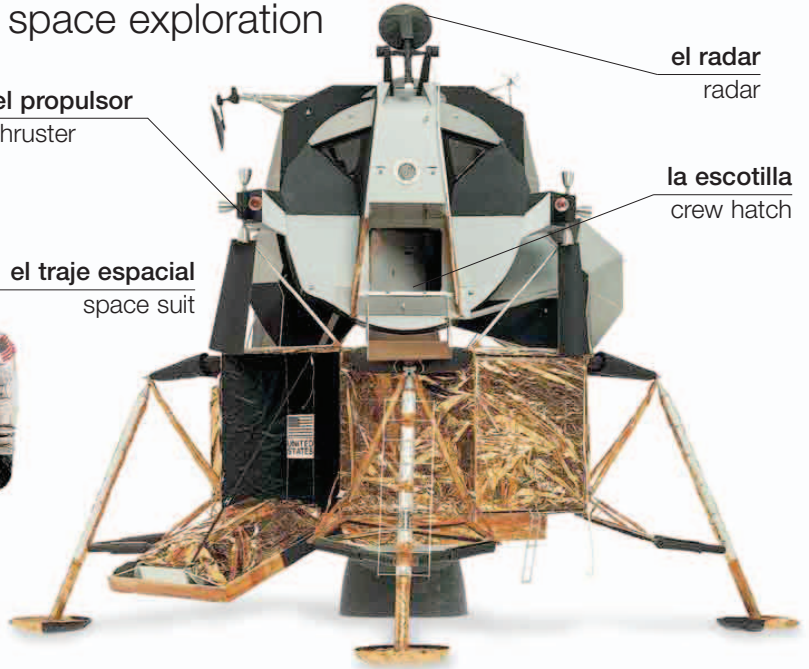

el módulo lunar | lunar module

la rampa de lanzamiento
launch pad

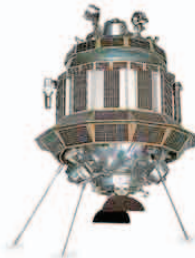

el satélite
satellite



la estación espacial
space station

la astronomía • astronomy



la constelación
constellation



los prismáticos
binoculars

el telescopio
telescope

el trípode
tripod



la Tierra • Earth

el polo
pole

el océano
ocean

el mar
sea

el continente
continent

la tierra firme
land

la cadena
montañosa
mountain range

la península
peninsula

la isla
island



el planeta | planet

la atmósfera
atmosphere

el manto
mantle

el núcleo
interno
inner core

la corteza
crust

el núcleo
externo
outer core

la sección
section

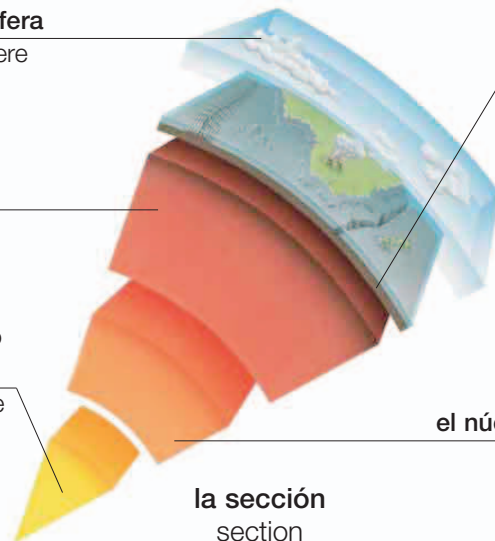

el círculo Polar Ártico

Arctic circle

el trópico de Cáncer

tropic of Cancer

los trópicos
tropics

el trópico de Capricornio

tropic of Capricorn

la lava
lava

la ceniza
ash

la cámara
chamber

el volcán | volcano

la chimenea
vent

el magma
magma

las zonas | zones

el Polo Norte
North pole

el hemisferio norte
northern hemisphere

la longitud
longitude

la latitude
latitude

el hemisferio sur
southern hemisphere

el ecuador
equator

vocabulario

• vocabulary

el terremoto
earthquake

la placa
plate

hacer (entrar en) erupción
erupt (v)

el temblor
tremor



el cráter | crater

el paisaje • landscape

la montaña
mountain

la ladera
slope

la orilla
bank

el río
river

los rápidos
rapids

las rocas
rocks

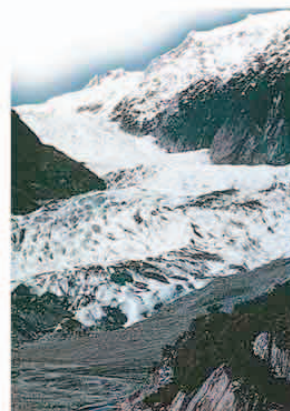
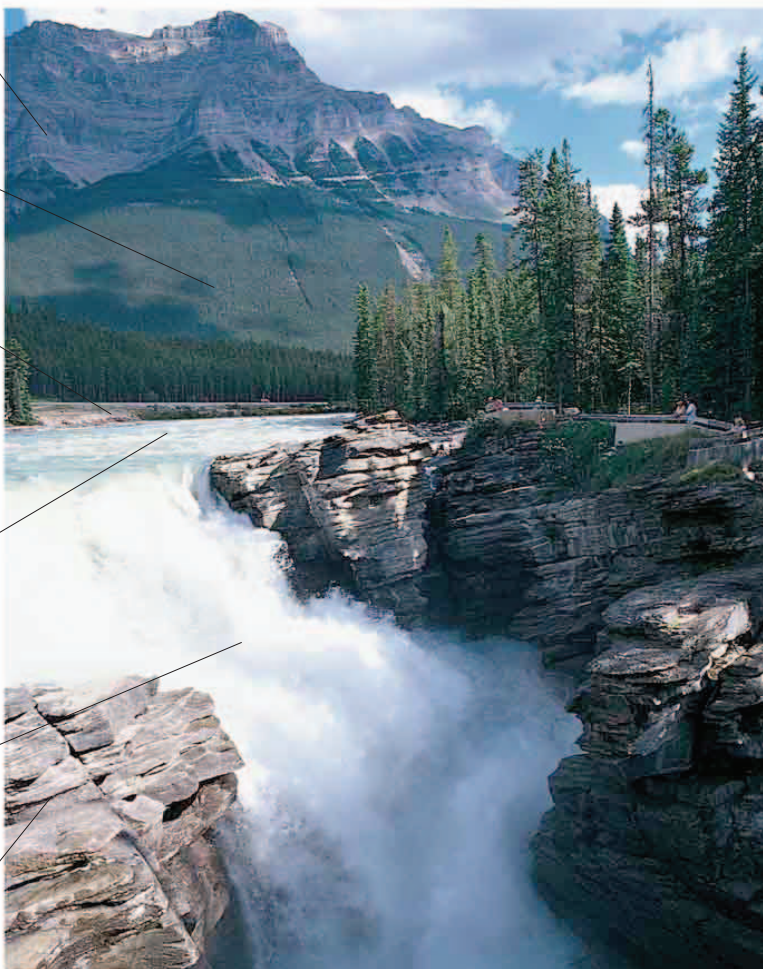

el glaciar
glacier

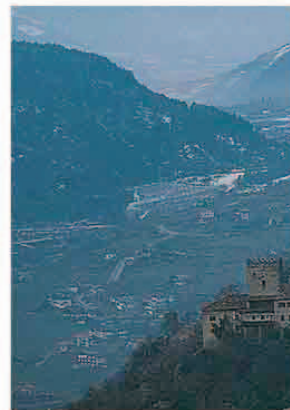

el valle | valley



la colina
las rocas



la meseta
plateau



el desfiladero
gorge

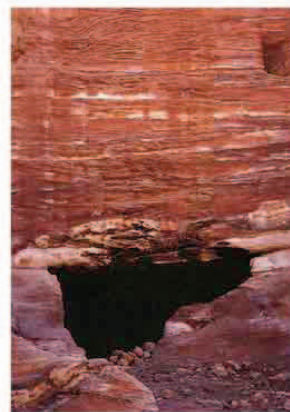

la cueva
cave



la llanura | plain



el desierto | desert



el bosque | forest



el bosque | wood



la selva tropical
rain forest



el pantano
swamp



el prado
meadow



la pradera
grassland



la cascada
waterfall



el arroyo
stream



el lago
lake



el géiser
geyser



la costa
coast



el acantilado
cliff



el arrecife de coral
coral reef



el estuario
estuary

el tiempo • weather

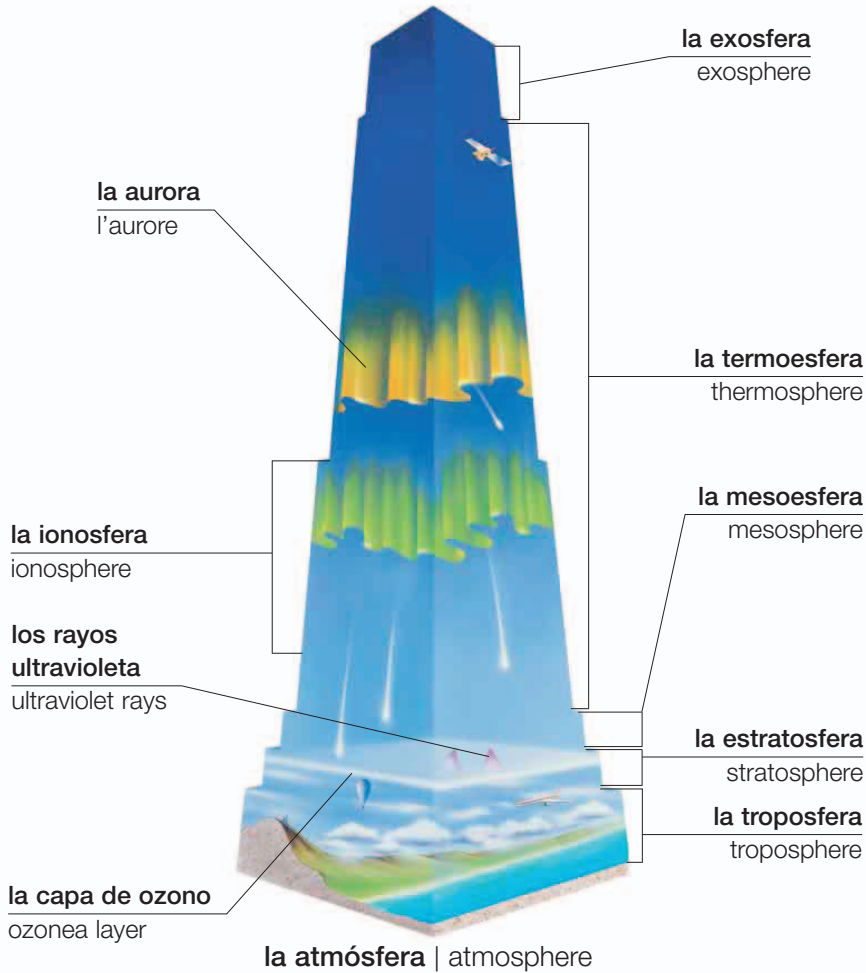

el sol
sunshine



el viento
wind

vocabulario • vocabulary

el aguanieve
sleet

el chubasco
shower

caluroso
hot

seco
dry

ventoso
windy

Tengo calor/frío.
I'm hot/cold.

el granizo
hail

soleado
sunny

frío
cold

lluvioso
wet

el temporal
gale

Está lloviendo.
It's raining.

el trueno
thunder

nublado
cloudy

cálido
warm

húmedo
humid

la temperatura
temperature

Estamos a ... grados.
It's ... degrees.



la nube
cloud



la lluvia
rain

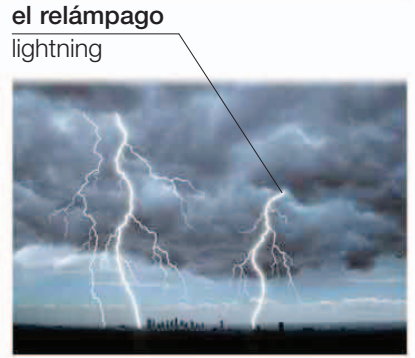

el relámpago
lightning

la tormenta
storm



la neblina
mist



la niebla
fog



el arcoiris
rainbow

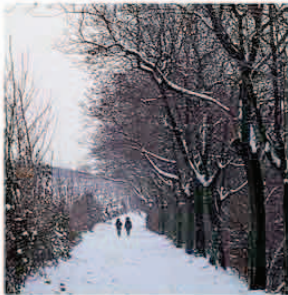

la nieve
snow



la escarcha
frost



el hielo
ice



el carámbano
icicle

la helada
freeze



el huracán
hurricane



el tornado
tornado



el monzón
monsoon



la inundación
flood

las rocas • rocks

ígneo • igneous



el granito
granite

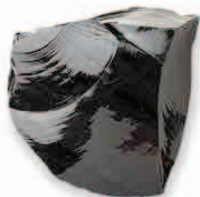

la obsidiana
obsidian



el basalto
basalt



la piedra pómez
pumice

sedimentario • sedimentary



la piedra arenisca
sandstone



la piedra caliza
limestone



la tiza
chalk



el pedernal
flint



el conglomerado
conglomerate



el carbón
coal

metamórfico •

metamorphic



la pizarra
slate



el esquisto
schist



el gneis
gneiss

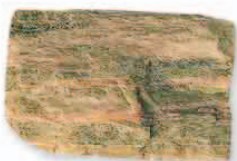

el mármol
marble

las gemas • gems

el rubí
ruby



la amatista
amethyst



el azabache
jet



el ópalo
opal



la adularia
(^ola piedra lunar)
moonstone



el granate
garnet



el diamante
diamond



la aguamarina
aquamarine



el jade
jade



la esmeralda
emerald



el zafiro
sapphire



la turmalina
tourmaline



el topacio
topaz



los minerales • minerals



el cuarzo
quartz



la mica
mica



el azufre
sulfur



la hematita
([©]el hematites)
hematite



la calcita
calcite



la malaquita
malachite



la turquesa
turquoise



el ónix ([©]el ónice)
onyx

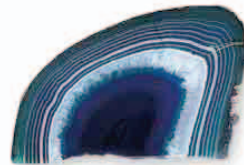

el ágata
agate



el grafito
graphite

los metales • metals



el oro
gold



la plata
silver



el platino
platinum



el níquel
nickel



el hierro
iron



el cobre
copper



el estaño
tin



el aluminio
aluminium



el mercurio
mercury

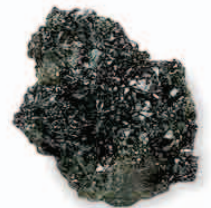

el zinc
zinc

los animales 1 • animals 1

los mamíferos • mammals



el conejo
rabbit



el hámster
hamster

los bigotes
whiskers



el ratón
mouse

la cola
tail

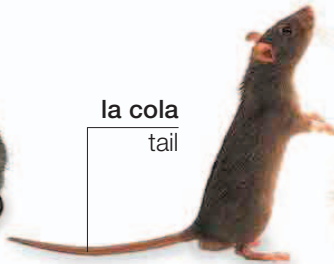

la rata
rat



el erizo
hedgehog



la ardilla
squirrel



el murciélago
bat



el mapache
raccoon



el zorro
fox



el lobo
wolf

el cachorro
puppy



el perro
dog

el gatito
kitten



el gato
cat

la cría
pup



la nutria
otter



la foca
seal



el león marino
sea lion

la aleta
flipper

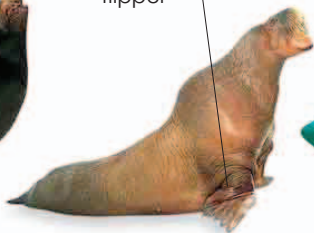

la morsa
walrus

el orificio nasal
blowhole



la ballena
whale



el delfín
dolphin

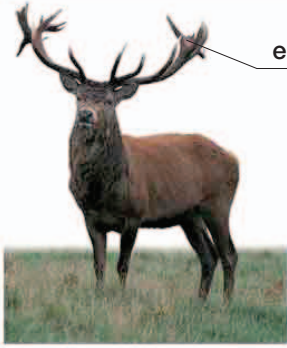

el asta
antler

el ciervo
deer

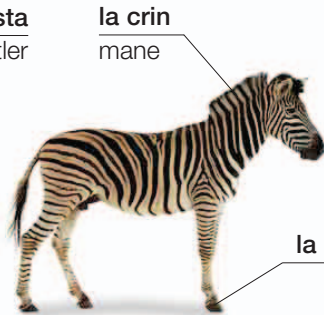

la crin
mane

la pezuña
hoof

la cebra
zebra



la jirafa
giraffe



la joroba
(^o la giba)
hump

el camello
camel



la trompa
trunk

el colmillo
tusk

el hipopótamo
hippopotamus

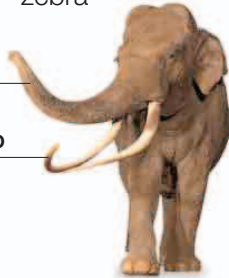

el elefante
elephant



el cuerno
horn

el rinoceronte
rhinoceros



el tigre
tiger

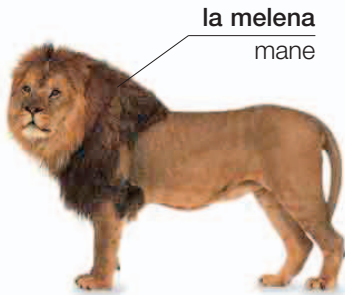

la melena
mane

el león
lion



el chango (^o el mono)
monkey



el gorila
gorilla



el koala
koala



la bolsa
pouch

el canguro
kangaroo



el oso
bear

la zarpa
claw



el oso polar
polar bear

el oso panda
panda



los animales 2 • animals 2

las aves • birds



el canario
canary



el gorrión
sparrow



el colibrí
hummingbird

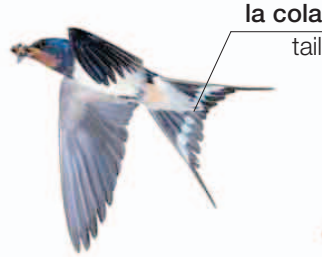

la golondrina
swallow



el cuervo
crow



la paloma
pigeon



el pájaro carpintero
woodpecker



el halcón
falcon



el búho
owl



la gaviota
gull

el águila
eagle



el pelícano
pelican



el flamenco
flamingo



la cigüeña
stork



la grulla
crane



el pingüino
penguin



el avestruz
ostrich



la oca | goose



el cisne
swan



el pavo real
peacock



el faisán
pheasant



el guajolote (el pavo)
turkey



el pico
beak

la cacatúa
cockatoo



la pluma
feather

el ala
wing

el loro
parrot

la garra
claw

los reptiles • reptiles

las escamas
scales



el caimán
alligator



el lagarto
lizard

la iguana
iguana



el galápago
turtle

el caparazón
shell



la tortuga
tortoise

la serpiente
snake



el hocico
snout



el cocodrilo
crocodile

los animales 3 • animals 3

los anfibios • amphibians



la rana
frog



el sapo
toad



el renacuajo
tadpole



la salamandra
salamander

los peces • fish



la anguila
eel

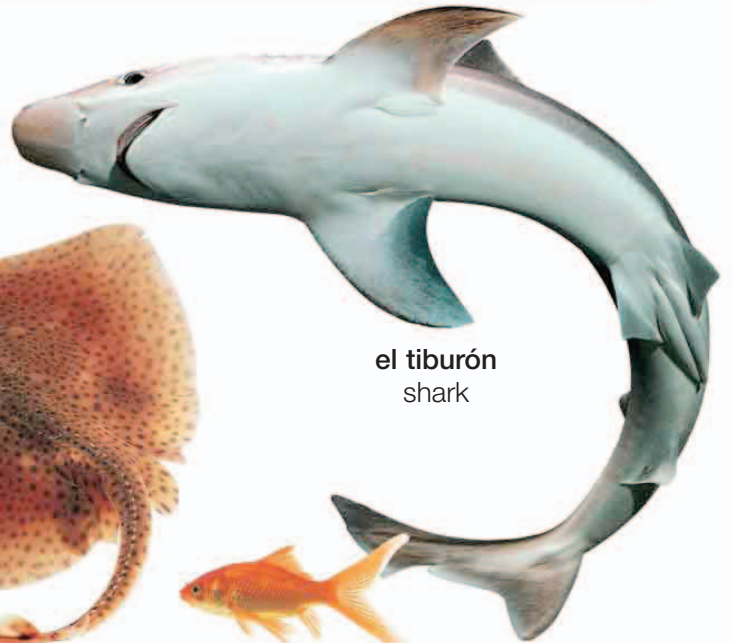

el tiburón
shark



el caballito de mar
sea horse



la raya
skate



la raya
ray



el pez de colores
goldfish

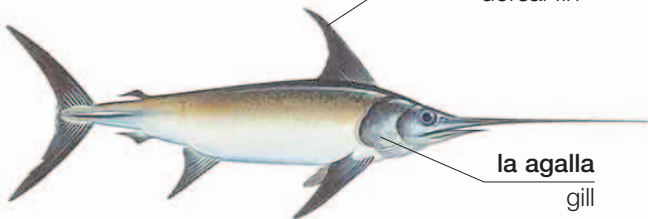

el pez espada
swordfish

la aleta pectoral
pectoral fin

la cola
tail

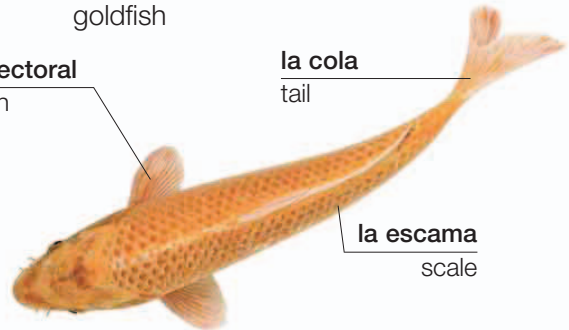

la carpa koi
koi carp

los invertebrados • invertebrates



la hormiga
ant



la termita
termite



la abeja
bee



la avispa
wasp



el escarabajo
beetle



la cucaracha
cockroach



la polilla
moth



la mariposa
butterfly

la antena
antenna



el capullo
cocoon



la oruga
caterpillar



el grillo
cricket



el saltamontes
grasshopper



la mantis
religiosa
praying mantis



el acuijón
(^oel escorpión)
sting
scorpion



el ciempiés
centipede



la libélula
dragonfly



la mosca
fly



el mosquito
mosquito



la catarina
(^ola mariquita)
ladybug



la araña
spider



la babosa
slug



el caracol
snail



el gusano
worm



la estrella de mar
starfish



el mejillón
mussel



el cangrejo
crab



la langosta
lobster



el pulpo
octopus



el calamar
squid



la medusa
jellyfish

las plantas • plants

el árbol • tree

la rama
branch

la raíz
root



el alerce
larch



el arce
maple



el roble
oak



la haya
beech



el olmo
elm



el abedul
birch



el tilo
lime



la corteza
bark



el álamo
poplar



el pino
pine



el acebo
holly



el sauce
willow



el eucalipto
eucalyptus



el cedro
cedar



la palmera
palm

la planta de flor • flowering plant

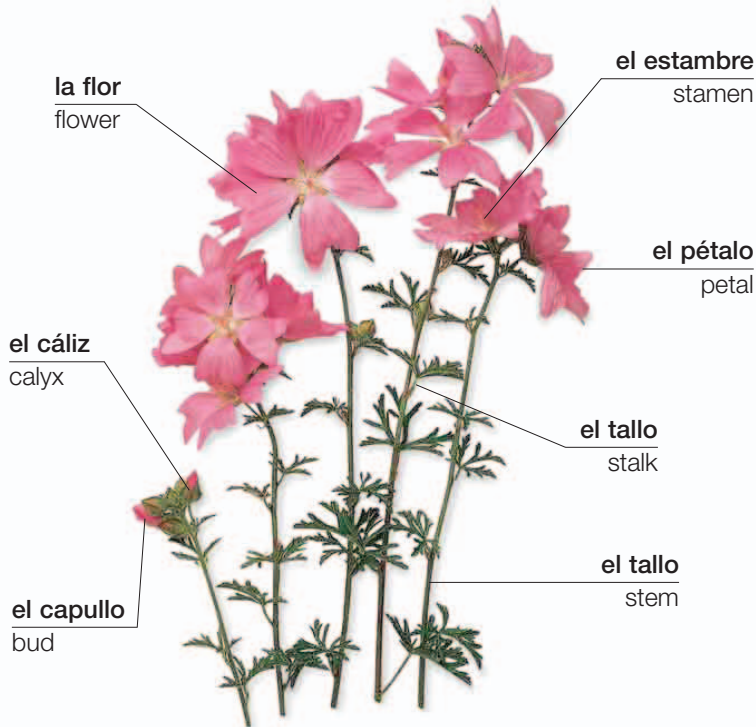

el ranúnculo
buttercup



la margarita
daisy



el cardo
thistle



el diente de león
dandelion



el brezo
heather



la amapola
poppy



la dedalera
foxglove



la madreselva
honeysuckle



el girasol
sunflower



el trébol
clover



los narcisos
silvestres
bluebells



la primula
primrose



el lupino
lupins



la ortiga
nettle

la ciudad • town



los edificios • buildings



el palacio municipal
town hall



la biblioteca
library



el cine
movie theater



el teatro
theater



la universidad
university



el rascacielos
skyscraper



la escuela
school

las zonas • areas



la zona industrial
industrial park



la ciudad
city



el suburbio
(^c la periferia)
suburb



el pueblo
village

vocabulario • vocabulary

la zona peatonal
pedestrian zone

la calle lateral
side street

la parada de autobús
bus stop

la alcantarilla
gutter

la iglesia
church

la avenida
avenue

la plaza
square

la coladera (^c la boca
de alcantarilla)
manhole

la fábrica
factory

el drenaje
(^c el sumidero)
drain

la arquitectura • architecture

los edificios y las estructuras • buildings and structures



el rascacielos
skyscraper



el castillo
castle



la iglesia
church

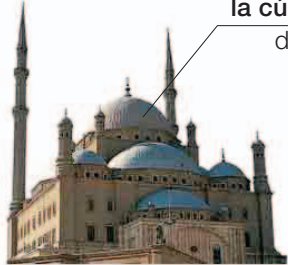

la mezquita
mosque



el templo
temple



la sinagoga
synagogue



el embalse
dam



el puente
bridge

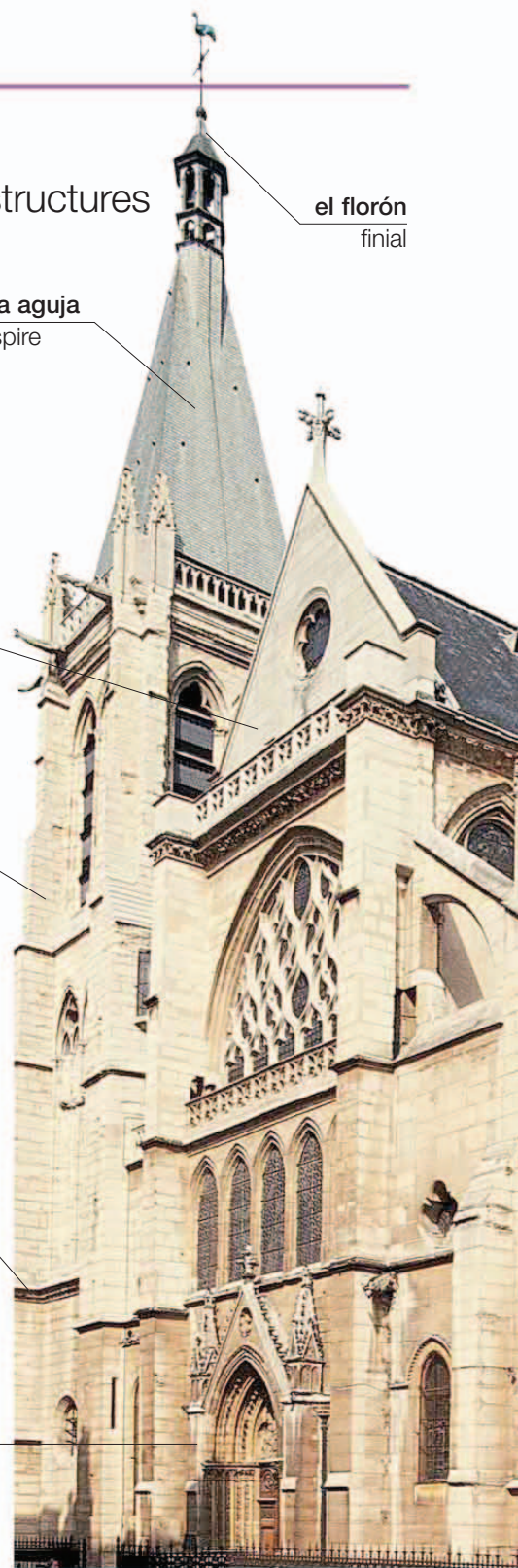

el florón
finial

el torreón
turret

la aguja
spire

el foso
moat

el frontón
gable

la cúpula
dome

la torre
tower

la bóveda
vault

la cornisa
cornice

la columna
pillar

la catedral | cathedral

los estilos • styles



gótico
Gothic

el arquitrabe
architrave



Renacimiento
Renaissance



barroco
baroque



el arco
arch

el friso
frieze

el coro
choir



rococó
rococo

el frontón
pediment



neoclásico
neoclassical

el contrafuerte
buttress



el estilo modernista
art nouveau



art decó
art deco

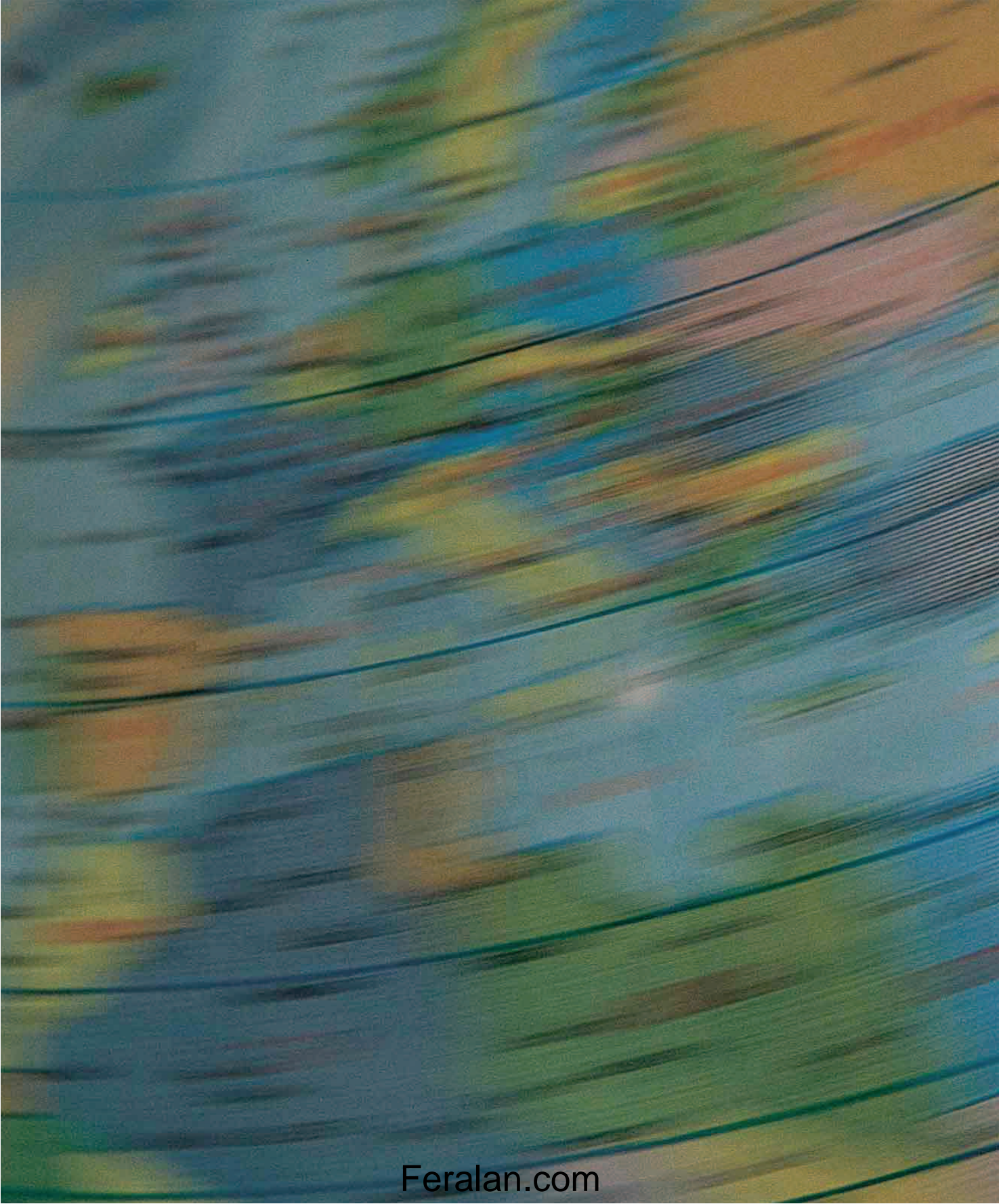

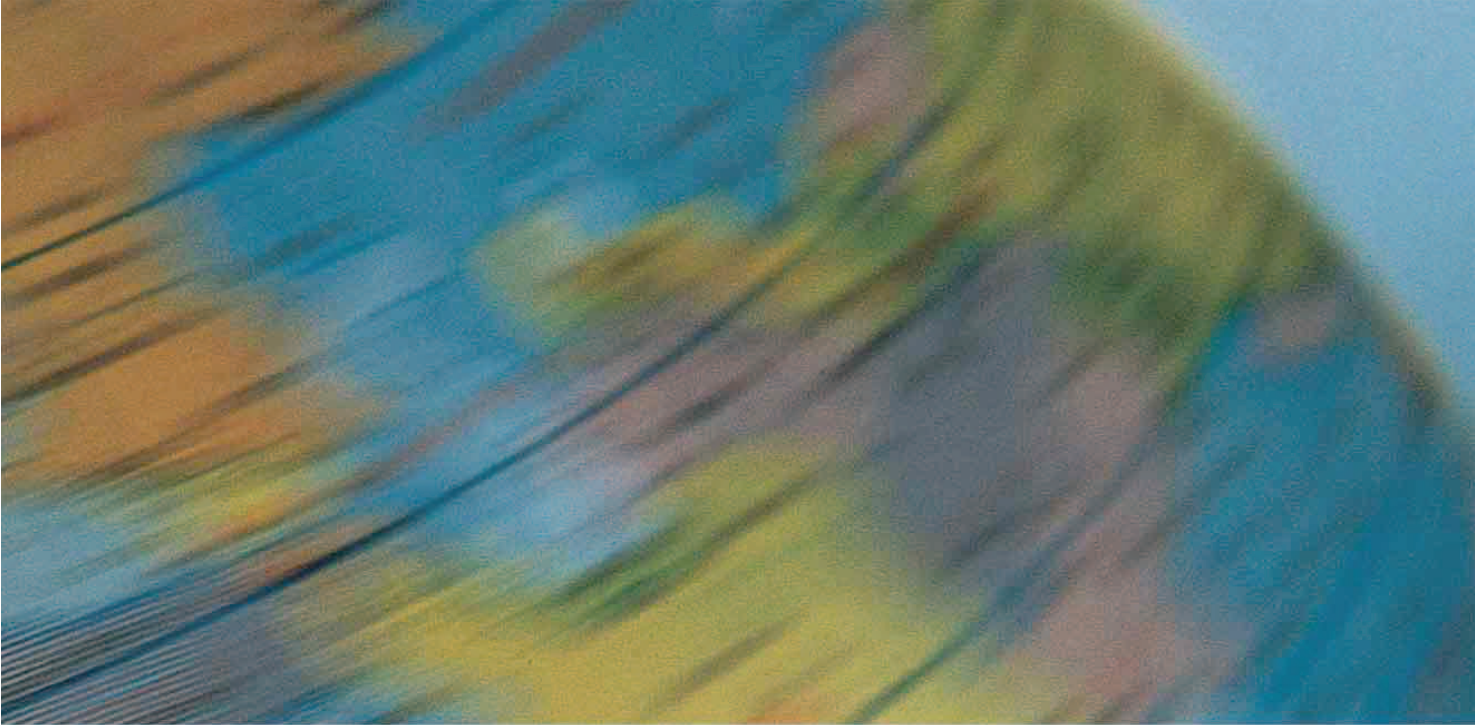

los datos
reference



el tiempo • time

el minuterero
minute hand

la manecilla (la
aguja) de la hora
hour hand



el reloj
clock

vocabulario • vocabulary

el segundo second	ahora now	un cuarto de hora a quarter of an hour
el minuto minute	más tarde later	veinte minutos twenty minutes
la hora hour	media hora half an hour	cuarenta minutos forty minutes

¿Qué hora es?
What time is it?

Son las tres en punto.
It's three o'clock.



la una y cinco
five after one



la una y diez
ten after one



la una y cuarto
quarter after one



la una y veinte
twenty after one



la una y veinticinco
twenty-five after one

el segundero
second hand



la una y media
one-thirty



las veinticinco para
las dos (las dos
menos veinticinco)
twenty-five to two



las veinte para las dos
(las dos menos veinte)
twenty to two



el cuarto para las dos
(las dos menos cuarto)
quarter to two



las diez para las dos
(las dos menos diez)
ten to two



las cinco para las dos
(las dos menos cinco)
five to two



las dos en punto
two o'clock

la noche y el día • night and day

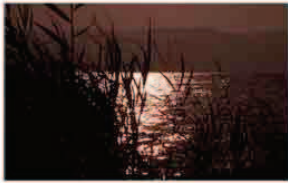

la medianoche
midnight



el amanecer
sunrise



el alba
dawn



la mañana
morning



el atardecer
(^cla puesta de sol)
sunset



el mediodía
noon

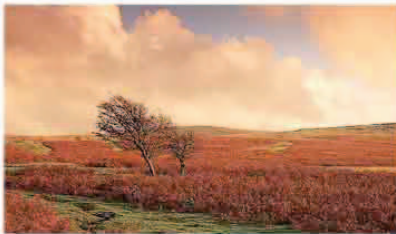

el anochecer
dusk



la noche
evening



la tarde
afternoon

vocabulario • vocabulary

temprano : Llegas temprano.
early : You're early.

Por favor, sé puntual.
Please be on time.

¿A qué hora termina?
What time does it end?

puntual : Llegas tarde.
on time : You're late.

Hasta luego.
I'll see you later.

¿Cuánto dura?
How long will it last?

tarde : Llegaré dentro de poco.
late : I'll be there soon.

¿A qué hora comienza?
What time does it start?

Se está haciendo tarde.
It's getting late.

el calendario (C el almanaque) • calendar

el mes
month

el año
year

enero
January

2010

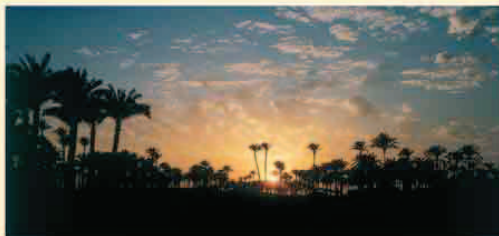

el día
day

lunes **martes** **miércoles** **jueves** **viernes** **sábado** **domingo**
Monday Tuesday Wednesday Thursday Friday Saturday Sunday

el día hábil
(C el día laborable)
workday

1	2	3	4	5	6	7
8	9	10	11	12	13	14
15	16	17	18	19	20	21

la semana
week

la fecha
date

ayer
yesterday

hoy
today

mañana
tomorrow

el fin de
semana
weekend

vocabulario • vocabulary

enero
January

marzo
March

mayo
May

julio
July

septiembre
September

noviembre
November

febrero
February

abril
April

junio
June

agosto
August

octubre
October

diciembre
December

los años • years

1900 mil novecientos • nineteen hundred

1901 mil novecientos uno • nineteen hundred and one

1910 mil novecientos diez • nineteen ten

2000 dos mil • two thousand

2001 dos mil uno • two thousand and one

las estaciones • seasons



la primavera
spring



el verano
summer



el otoño
fall



el invierno
winter

vocabulario • vocabulary

el siglo
century

la década
decade

el milenio
millennium

quince días
two weeks

esta semana
this week

la semana pasada
last week

la semana que viene
next week

anteayer (c antes de ayer)
the day before yesterday

pasado mañana
the day after tomorrow

semanalmente
weekly

mensual
monthly

anual
annual

.....
¿Qué día es hoy?
What's the date today?

Es el siete de febrero del dos mil dos.
It's February seventh, two thousand and two.

los números • numbers

0	cero • zero	20	veinte • twenty
1	uno • one	21	veintiuno • twenty-one
2	dos • two	22	veintidós • twenty-two
3	tres • three	30	treinta • thirty
4	cuatro • four	40	cuarenta • forty
5	cinco • five	50	cincuenta • fifty
6	seis • six	60	sesenta • sixty
7	siete • seven	70	setenta • seventy
8	ocho • eight	80	ochenta • eighty
9	nueve • nine	90	noventa • ninety
10	diez • ten	100	cien • one hundred
11	once • eleven	110	ciento diez • one hundred and ten
12	doce • twelve	200	doscientos • two hundred
13	trece • thirteen	300	trescientos • three hundred
14	catorce • fourteen	400	cuatrocientos • four hundred
15	quince • fifteen	500	quinientos • five hundred
16	dieciséis • sixteen	600	seiscientos • six hundred
17	diecisiete • seventeen	700	setecientos • seven hundred
18	dieciocho • eighteen	800	ochocientos • eight hundred
19	diecinueve • nineteen	900	novcientos • nine hundred

1,000	mil • one thousand
10,000	diez mil • ten thousand
20,000	veinte mil • twenty thousand
50,000	cincuenta mil • fifty thousand
55,500	cincuenta y cinco mil quinientos • fifty-five thousand five hundred
100,000	cien mil • one hundred thousand
1,000,000	un millón • one million
1,000,000,000	mil millones • one billion



cuarto • fourth	décimo • tenth
quinto • fifth	undécimo • eleventh
sexto • sixth	duodécimo • twelfth
séptimo • seventh	decimotercero • thirteenth
octavo • eighth	decimocuarto • fourteenth
noveno • ninth	decimoquinto • fifteenth

decimosexto • sixteenth	trigésimo • thirtieth
decimoséptimo • seventeenth	cuadragésimo • fortieth
décimo octavo • eighteenth	quincuagésimo • fiftieth
décimo noveno • nineteenth	sexagésimo • sixtieth
vigésimo • twentieth	septuagésimo • seventieth
vigésimo primero • twenty-first	octogésimo • eightieth
vigésimo segundo • twenty-second	nonagésimo • ninetieth
vigésimo tercero • twenty-third	centésimo • one hundredth

los pesos y las medidas • weights and measures

el área • area

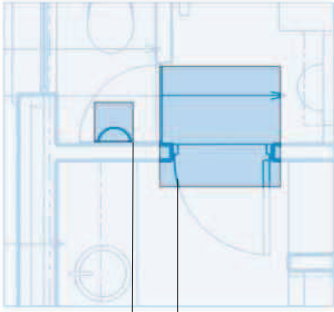

el pie cuadrado
square foot

el metro cuadrado
square meter

la distancia • distance

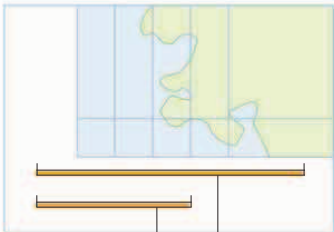

el kilómetro
kilometre

la milla
mile

la longitud • length

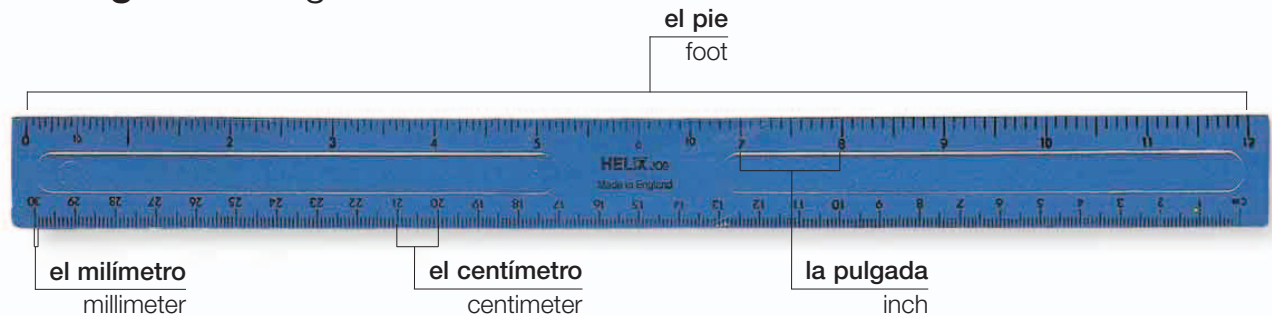

el pie
foot

el milímetro
millimeter

el centímetro
centimeter

la pulgada
inch

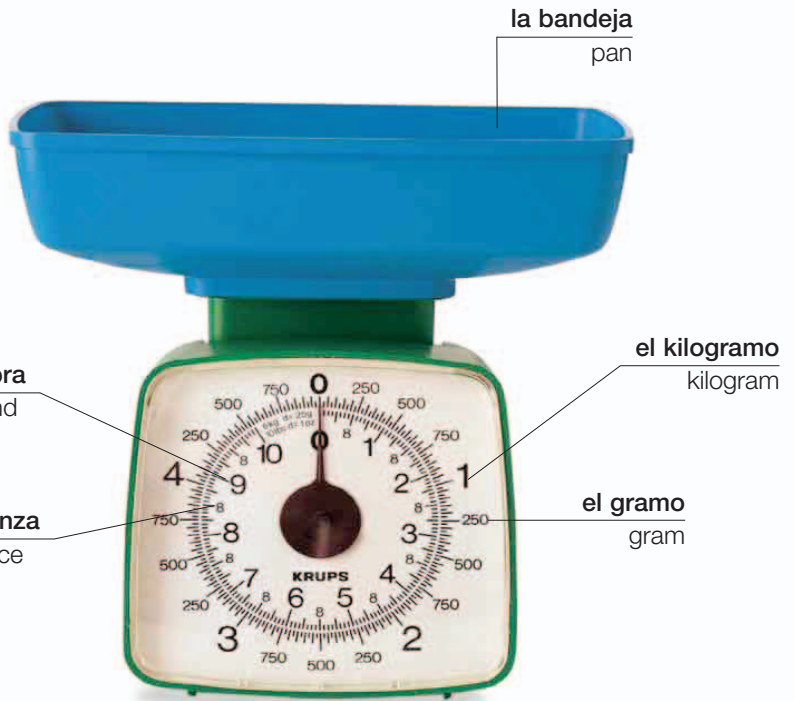

la bandeja
pan

la libra
pound

la onza
ounce

el kilogramo
kilogram

el gramo
gram

la báscula (c) la balanza | scale

vocabulario • vocabulary

la yarda
yard

la tonelada
tonne

medir
measure (v)

el metro
metre

el miligramo
milligram

pesar
weigh (v)

la capacidad • capacity

el medio litro
half-liter

la pinta
pint

el volumen
volume

el mililitro
milliliter



la jarra graduada
measuring cup



la medida de capacidad
liquid measure

vocabulario •
vocabulary

el galón
gallon

el cuarto de galón
quart

el litro
liter

el recipiente • container



el tetrabrik
carton



el paquete
bag



la botella
bottle



la bolsa
sack



la tarrina | tub



el tarro | jar

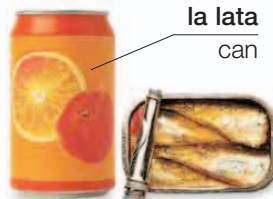

la lata
can

la lata | tin



el pulverizador
spray bottle



la pastilla
bar



el tubo
tube



el rollo
roll



la cajetilla (el paquete)
pack



el spray
spray can

el mapamundi • world map

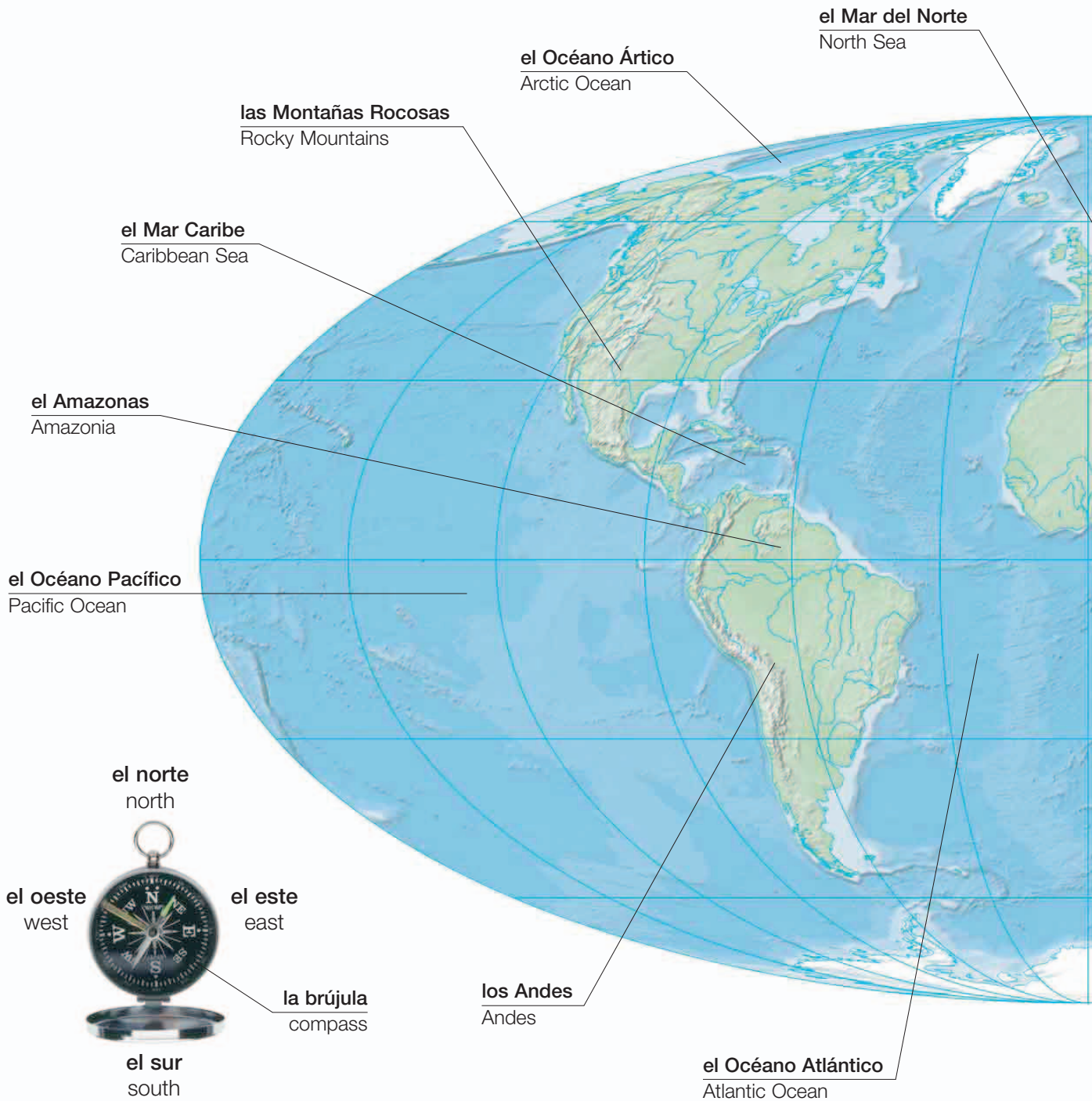



América del Norte y Central • North and Central America



- 1 **Alaska** • Alaska
- 2 **Canadá** • Canada
- 3 **Groenlandia** • Greenland
- 4 **Estados Unidos de América**
 - United States of America
- 5 **México** • Mexico
- 6 **Guatemala** • Guatemala
- 7 **Belice** • Belize
- 8 **El Salvador** • El Salvador
- 9 **Honduras** • Honduras
- 10 **Nicaragua** • Nicaragua
- 11 **Costa Rica** • Costa Rica
- 12 **Panamá** • Panama
- 13 **Cuba** • Cuba
- 14 **Bahamas** • Bahamas
- 15 **Jamaica** • Jamaica
- 16 **Haití** • Haiti
- 17 **República Dominicana**
 - Dominican Republic
- 18 **Puerto Rico** • Puerto Rico
- 19 **Barbados** • Barbados
- 20 **Trinidad y Tobago** • Trinidad and Tobago
- 21 **Saint Kitts y Nevis** • St. Kitts and Nevis
- 22 **Antigua y Barbuda** • Antigua and Barbuda
- 23 **Dominica** • Dominica
- 24 **Santa Lucía** • St. Lucia
- 25 **San Vicente y las Granadinas**
 - St. Vincent and the Grenadines
- 26 **Granada** • Grenada

América del Sur • South America



- 1 **Venezuela** • Venezuela
- 2 **Colombia** • Colombia
- 3 **Ecuador** • Ecuador
- 4 **Perú** • Peru
- 5 **las Islas Galápagos**
 - Galápagos Islands
- 6 **Guyana** • Guyana
- 7 **Suriname** • Suriname
- 8 **la Guayana Francesa**
 - French Guiana
- 9 **Brasil** • Brazil
- 10 **Bolivia** • Bolivia
- 11 **Chile** • Chile
- 12 **Argentina** • Argentina
- 13 **Paraguay** • Paraguay
- 14 **Uruguay** • Uruguay
- 15 **las Malvinas**
 - Falkland Islands

vocabulario • vocabulary

el continente	el principado	la provincia
continent	principality	province

el país	el territorio	el distrito
country	territory	district

la nación	la colonia	la región
nation	colony	region

el estado	la zona	la capital
state	zone	capital

Europa • Europe

- 1 **Irlanda** • Ireland
- 2 **Reino Unido** • United Kingdom
- 3 **Portugal** • Portugal
- 4 **España** • Spain
- 5 **las Islas Baleares** • Balearic Islands
- 6 **Andorra** • Andorra
- 7 **Francia** • France
- 8 **Bélgica** • Belgium
- 9 **los Países Bajos** • Netherlands
- 10 **Luxemburgo** • Luxembourg
- 11 **Alemania** • Germany
- 12 **Dinamarca** • Denmark
- 13 **Noruega** • Norway
- 14 **Suecia** • Sweden
- 15 **Finlandia** • Finland
- 16 **Estonia** • Estonia
- 17 **Letonia** • Latvia
- 18 **Lituania** • Lithuania
- 19 **Kaliningrado** • Kaliningrad
- 20 **Polonia** • Poland
- 21 **República Checa** • Czech Republic
- 22 **Austria** • Austria
- 23 **Liechtenstein** • Liechtenstein
- 24 **Suiza** • Switzerland
- 25 **Italia** • Italy
- 26 **Mónaco** • Monaco
- 27 **Córcega** • Corsica
- 28 **Cerdeña** • Sardinia
- 29 **San Marino** • San Marino

- 30 **la Ciudad del Vaticano** • Vatican City
- 31 **Sicilia** • Sicily
- 32 **Malta** • Malta
- 33 **Eslovenia** • Slovenia
- 34 **Croacia** • Croatia
- 35 **Hungría** • Hungary
- 36 **Eslovaquia** • Slovakia
- 37 **Ucrania** • Ukraine
- 38 **Belarús** • Belarus
- 39 **Moldavia** • Moldova

- 40 **Rumanía** • Romania
- 41 **Serbia** • Serbia
- 42 **Bosnia y Herzegovina** • Bosnia and Herzegovina
- 43 **Albania** • Albania
- 44 **Macedonia** • Macedonia
- 45 **Bulgaria** • Bulgaria
- 46 **Grecia** • Greece
- 47 **Kosovo** • Kosovo
- 48 **Montenegro** • Montenegro
- 49 **Islandia** • Iceland



África • Africa

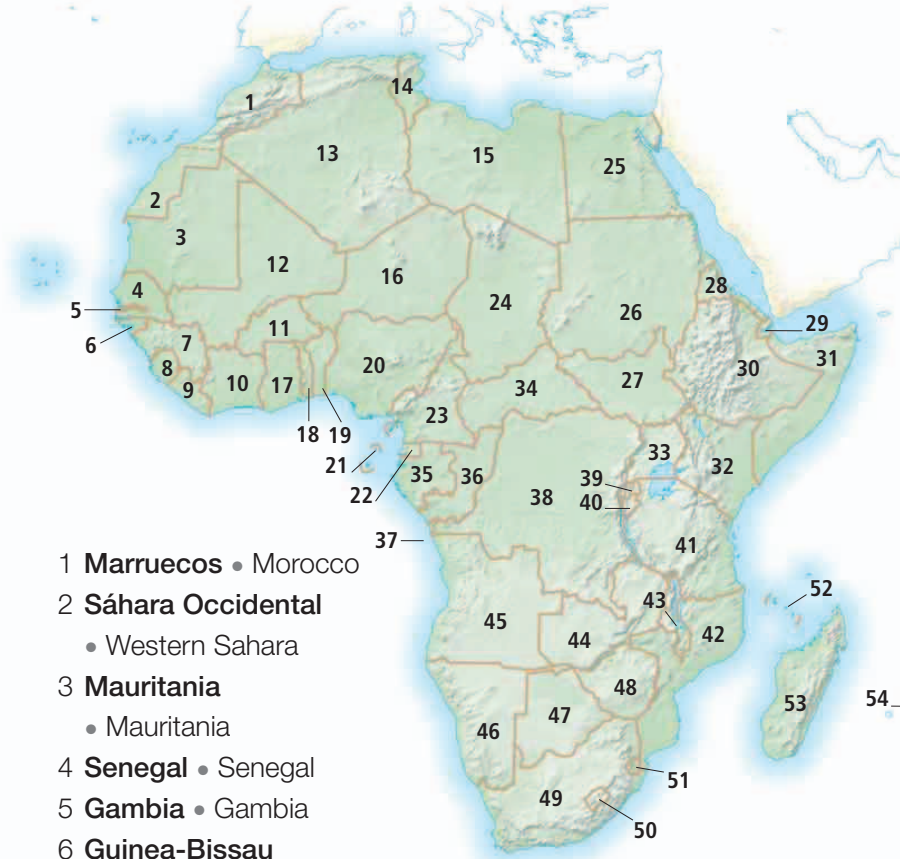

- 1 **Marruecos** • Morocco
- 2 **Sáhara Occidental**
• Western Sahara
- 3 **Mauritania**
• Mauritania
- 4 **Senegal** • Senegal
- 5 **Gambia** • Gambia
- 6 **Guinea-Bissau**
• Guinea-Bissau
- 7 **Guinea** • Guinea
- 8 **Sierra Leona**
• Sierra Leone
- 9 **Liberia** • Liberia
- 10 **Costa de Marfil**
• Ivory Coast
- 11 **Burquina Faso**
• Burkina Faso
- 12 **Malí** • Mali
- 13 **Argelia** • Algeria
- 14 **Túnez** • Tunisia
- 15 **Libia** • Libya
- 16 **Níger** • Niger
- 17 **Ghana** • Ghana
- 18 **Togo** • Togo
- 19 **Benin** • Benin
- 20 **Nigeria** • Nigeria
- 21 **Santo Tomé y Príncipe**
• São Tomé and Príncipe
- 22 **Guinea Ecuatorial**
• Equatorial Guinea
- 23 **Camerún** • Cameroon
- 24 **Chad** • Chad
- 25 **Egipto** • Egypt
- 26 **Sudán** • Sudan
- 27 **Sudán del Sur** • South Sudan
- 28 **Eritrea** • Eritrea
- 29 **Djibouti** • Djibouti
- 30 **Etiopía** • Ethiopia
- 31 **Somalia** • Somalia
- 32 **Kenya** • Kenya
- 33 **Uganda** • Uganda
- 34 **República Centroafricana**
• Central African Republic
- 35 **Gabón** • Gabon
- 36 **Congo** • Congo
- 37 **Cabinda** • Cabinda
- 38 **República Democrática del Congo** • Democratic Republic of the Congo
- 39 **Rwanda** • Rwanda
- 40 **Burundi** • Burundi
- 41 **Tanzania** • Tanzania
- 42 **Mozambique**
• Mozambique
- 43 **Malawi** • Malawi
- 44 **Zambia** • Zambia
- 45 **Angola** • Angola
- 46 **Namibia** • Namibia
- 47 **Botswana** • Botswana
- 48 **Zimbabue** • Zimbabwe
- 49 **Sudáfrica** • South Africa
- 50 **Lesotho** • Lesotho
- 51 **Swazilandia** • Swaziland
- 52 **Comoros** • Comoros
- 53 **Madagascar** • Madagascar
- 54 **Mauricio** • Mauritius

Asia • Asia

- 1 **la Turchia** • Turkey
- 2 **Cipro** • Cyprus
- 3 **Federación Rusa**
 - Russian Federation
- 4 **Georgia** • Georgia
- 5 **Armenia** • Armenia
- 6 **Azerbaiyán** • Azerbaijan
- 7 **Irán** • Iran
- 8 **Iraq** • Iraq
- 9 **Siria** • Syria
- 10 **Líbano** • Lebanon
- 11 **Israel** • Israel
- 12 **Jordania** • Jordan
- 13 **Arabia Saudita**
 - Saudi Arabia
- 14 **Kuwait** • Kuwait
- 15 **Bahrein** • Bahrain
- 16 **Qatar** • Qatar
- 17 **Emiratos Árabes Unidos**
 - United Arab Emirates
- 18 **Omán** • Oman
- 19 **Yemen** • Yemen
- 20 **Kazajstán** • Kazakhstan
- 21 **Uzbekistán** • Uzbekistan
- 22 **Turkmenistán** • Turkmenistan
- 23 **Afganistán** • Afghanistan
- 24 **Tayikistán** • Tajikistan
- 25 **Kirguistán** • Kyrgyzstan
- 26 **Pakistán** • Pakistan
- 27 **India** • India
- 28 **Maldivas** • Maldives
- 29 **Sri Lanka** • Sri Lanka
- 30 **China** • China
- 31 **Mongolia** • Mongolia
- 32 **Corea del Norte** • North Korea
- 33 **Corea del Sur** • South Korea
- 34 **Japón** • Japan



- 35 **Nepal** • Nepal
- 36 **Bhutan** • Bhutan
- 37 **Bangladesh** • Bangladesh
- 38 **Birmania (Myanmar)**
 - Burma (Myanmar)
- 39 **Tailandia** • Thailand
- 40 **Laos** • Laos

Australasia • Australasia



- 1 **Australia** • Australia
- 2 **Tasmania** • Tasmania
- 3 **Nueva Zelandia** • New Zealand

- 41 **Viet Nam** • Vietnam
- 42 **Camboya** • Cambodia
- 43 **Malasia** • Malaysia
- 44 **Singapur** • Singapore
- 45 **Indonesia** • Indonesia
- 46 **Brunei** • Brunei
- 47 **Filipinas** • Philippines
- 48 **Timor Oriental** • East Timor
- 49 **Papua Nueva Guinea** • Papua New Guinea
- 50 **Islas Salomón** • Solomon Islands
- 51 **Vanuatu** • Vanuatu
- 52 **Fiji** • Fiji

partículas y antónimos • particles and antonyms

a, hacia to	de, desde from	para for	hacia toward
encima de over	debajo de under	por along	al otro lado de across
delante de in front of	detrás de behind	con with	sin without
sobre onto	dentro de into	antes before	después after
en in	fuera out	antes de by	hasta until
sobre above	bajo below	temprano early	tarde late
dentro inside	fuera outside	ahora now	más tarde later
arriba up	abajo down	siempre always	nunca never
en at	más allá de beyond	con frecuencia (Ca menudo) often	rara vez rarely
a través de through	alrededor de around	ayer yesterday	mañana tomorrow
encima de on top of	al lado de beside	primer first	último last
entre between	en frente de opposite	cada every	algunos some
cerca near	lejos far	unos about	exactamente exactly
aquí here	allí there	un poco a little	mucho a lot

grande
large**pequeño**
small**caliente**
hot**frío**
cold**ancho**
wide**estrecho**
narrow**abierto**
open**cerrado**
closed**alto**
tall**bajo**
short**lleno**
full**vacío**
empty**alto**
high**bajo**
low**nuevo**
new**viejo**
old**grueso**
thick**delgado**
thin**claro**
light**oscuro**
dark**ligero**
light**pesado**
heavy**fácil**
easy**difícil**
difficult**duro**
hard**blando**
soft**libre**
free**ocupado**
occupied**húmedo**
wet**seco**
dry**fuerte**
strong**débil**
weak**bueno**
good**malo**
bad**gordo**
fat**delgado**
thin**rápido**
fast**lento**
slow**joven**
young**viejo**
old**correcto**
correct**incorrecto**
wrong**mejor**
better**peor**
worse**limpio**
clean**sucio**
dirty**negro**
black**blanco**
white**hermoso** (C bonito)
beautiful**feo**
ugly**interesante**
interesting**aburrido**
boring**caro**
expensive**barato**
cheap**enfermo**
sick**bien**
well**silencioso**
quiet**ruidoso**
noisy**el principio**
beginning**el final**
end

frases útiles • useful phrases

frases esenciales

• essential phrases

Sí

Yes

No

No

Quizás

Maybe

Por favor

Please

Gracias

Thank you

De nada

You're welcome

Perdone

Excuse me

Lo siento

I'm sorry

No

Don't

Vale

OK

Así vale

That's fine

Está bien

That's correct

Está mal

That's wrong

saludos • greetings

Hola

Hello

Adiós

Goodbye

Buenos días

Good morning

Buenas tardes

Good afternoon

Buenas tardes

Good evening

Buenas noches

Good night

¿Cómo está?

How are you?

Me llamo...

My name is...

¿Cómo se llama?

What is your name?

¿Cómo se llama?

What is his/her name?

Le presento a...

May I introduce...

Este es...

This is...

Encantado de conocerle

Pleased to meet you

Hasta luego

See you later

letreros • signs

Información

Tourist information

Entrada

Entrance

Salida

Exit

Salida de emergencia

Emergency exit

Empuje

Push

Peligro

Danger

Prohibido fumar

No smoking

Fuera de servicio

Out of order

Horario de apertura

Opening times

Entrada libre

Free admission

Llame antes de entrar

Knock before entering

Rebajado

Reduced

Saldos

Sale

Prohibido pisar el césped

Keep off the grass

ayuda • help

¿Me puede ayudar?

Can you help me?

No entiendo

I don't understand

No lo sé

I don't know

¿Habla inglés, francés...?

Do you speak English, French...?

Hablo inglés, español...

I speak English, Spanish...

Hable más lento (C despacio), por favor

Please speak more slowly

¿Me lo puede escribir?

Please write it down for me

He perdido...

I have lost...

indicaciones •
directions

Me perdí (C **Me he perdido**) I I am lost

¿Dónde está el/la...?
Where is the...?

¿Dónde está el/la... más cercano/a?
Where is the nearest...?

¿Dónde están los servicios?
Where are the restrooms?

¿Cómo voy a...?
How do I get to...?

A la derecha
To the right

A la izquierda
To the left

Todo recto
Straight ahead

¿A qué distancia está...?
How far is...?

las señales de tránsito (C **las señales de tráfico**)
• road signs

Todas las direcciones
All directions

Precaución I Caution

Prohibido el paso
No entry

Disminuir velocidad
Slow down

Desvío I Detour

Circular por la derecha
Keep right

Autopista I Freeway

Prohibido estacionar (C **Prohibido aparcar**)
No parking

Callejón sin salida
No through road

Sentido único
One-way

Ceda el paso
Yield

Carretera cortada
Road closed

Obras
Road construction

Curva peligrosa
Dangerous curve

alojamiento
• accommodation

Tengo una reservación (C **Tengo una reserva**)
I have a reservation

¿A qué hora es el desayuno?
What time is breakfast?

El número de mi habitación es el ...
My room number is ...

Volveré a las ...
I'll be back at ... o'clock

¿Dónde está el comedor?
Where is the dining room?

Me marcho mañana
I'm leaving tomorrow

comida y bebida
• eating and drinking

¡Salud!
Cheers!

Está buenísimo/malísimo
It's delicious/awful

Yo no bebo/fumo
I don't drink/smoke

Yo no como carne
I don't eat meat

Ya no más, gracias
No more for me, thank you

¿Puedo repetir?
May I have some more?

¿Me trae la cuenta?
Check, please.

¿Me da un recibo?
Can I have a receipt?

Zona de no fumadores
No-smoking area

la salud
• health

No me encuentro bien
I don't feel well

Tengo náuseas
I feel sick

¿Cuál es el número del médico más cercano?
What is the telephone number of the nearest doctor?

Me duele aquí
It hurts here

Tengo fiebre
I have a fever

Estoy embarazada de ... meses
I'm ... months pregnant

Necesito una receta para ...
I need a prescription for ...

Normalmente tomo ...
I normally take ...

Soy alérgico a ...
I'm allergic to ...

¿Estará bien?
Will he/she be all right?

índice español • Spanish index

- A**
a 320
a la carta 152
a la plancha 159
a salvo 228
a través de 320
abadejo *m* 120
abajo 320
abdomen *m* 12
abdominal *m* 16, 251
abedul *m* 296
abeja *f* 295
abierta *f* 221
abierto 260, 321
abogado *m* 180, 190
abonar 91
abonar en la superficie 90
abono *m* 91
abono compuesto *m* 88
aborto espontáneo *m* 52
abrazadera *f* 78
abrebotellas *m* 68, 150
abrelatas *m* 68
abrigo *m* 32
abril 306
absuelto 181
abuela *f* 22
abuelo *m* 22
abuelos *m* 23
aburrido 25
acacia *f* 110
academia de danza *f* 169
acampar 266
acantilado *m* 285
accesorios *m* 36, 38
accidente *m* 46
accidente de coche *m* 203
acciones *f* 77, 97, 227, 229, 233
acebo *m* 296
accedera *f* 123
aceite *m* 142, 199
aceite aromatizado *m* 134
aceite de almendra *m* 134
aceite de avellanas *m* 134
aceite de cacahuete *m* 135
aceite de colza *m* 135
aceite de girasol *m* 134
aceite de maíz *m* 135
aceite de nueces *m* 134
aceite de oliva *m* 134
aceite de presión en frío *m* 135
aceite de semillas de uva *m* 134
aceite de sésamo *m* 134
aceite vegetal *m* 135
aceites *m* 134
aceites esenciales *m* 55
aceituna negra *f* 143
aceituna rellena *f* 143
aceituna verde *f* 143
aceitunas *f* 151
acelerador *m* 200, 204
acelga *f* 123
acelga china *f* 123
acera *f* 298
acero inoxidable *m* 79
aclarar 76
acolchado *m* 277
acomodador *m* 255
acompañamiento *m* 153
acontecimientos de una vida *m* 26
acostarse 71
acta *m* 174
actividades *f* 162, 183, 245, 263
actividades al aire libre *f* 262
actor *m* 254
actores *m* 179
actriz *f* 191, 254
acuarelas *f* 274
acupresión *f* 55
acupuntura *f* 55
acusación *f* 180
acusado *m* 180, 181
adelantar 195
adiós 322
adobado 143, 159
adolescente *m/f* 23
adornos para el jardín *m* 84
adosado 58
adosado por un lado 58
aduanas *f* 212
aduanas del puerto *f* 216
adulto *m* 23
adversario *m* 236
aerodeslizador *m* 215
aeropuerto *m* 212
afeitado *m* 73
Afganistán 318
afilador *m* 68, 118
África 317
aftershave *m* 73
agalla *f* 294
agarradera *f* 166
agarre *m* 237
ágata *f* 289
agencia de viajes *f* 114
agencia inmobiliaria *f* 115
agenda *f* 173, 175
agente de bolsa *m* 97
agente de policía *m* 94
agente de viajes *f* 190
agente inmobiliario *f* 189
agitador *m* 150
aglomerado *m* 79
agosto 306
agresión *f* 94
agricultor *m* 189
agua *m* 144, 238
agua de colonia *m* 41
agua del grifo *m* 144
agua embotellada *m* 144
agua mineral *m* 144
aguacate *m* 128
aguamarina *f* 288
aguanieve *f* 286
aguarrás *m* 83
águila *f* 292
aguja *f* 109, 276, 300
aguja de ganchillo *f* 277
aguja de la hora *f* 304
aguja de tejer *f* 277
agujero negro *m* 280
ahogarse 47, 239
ahora 304
ahorros *m* 96
ahumado 118, 121, 143, 159
aikido *m* 236
airbag *m* 201
aire acondicionado *m* 200
airear 91
aislamiento *m* 61
ajedrez *m* 272
ajo *m* 125, 132
al lado de 320
al otro lado de 320
al vapor 159
ala *f* 210, 293
ala *m* 119
ala delta *m* 248
álambre *m* 79, 89
álamo *m* 296
alargador *m* 78
alarma antirrobo *f* 58
alarma contra incendios *f* 95
Alaska 314
alba *m* 305
albahaca *f* 133
Albania 316
albañil *m* 186, 188
albaricque *m* 126
albóndigas *f* 158
albornoz *m* 73
álbum de fotos *m* 271
alcachofa *f* 89, 124
alcachofa de la ducha *f* 72
alcantarilla *f* 299
alcaparras *f* 143
alcázar *m* 214
alcorza *f* 141
aldaba *f* 59
Alemania 316
alerce *m* 296
alergia *f* 44
alero *m* 58
alerón *m* 210
aleta *f* 210, 239, 292
aleta dorsal *f* 294
aleta pectoral *f* 294
aletas de raya *f* 120
alfalfa *f* 184
alfil *m* 272
alfiler *m* 276
alfiler de corbata *m* 36
alfilero *m* 276
alfombra *f* 63
alfombrilla de baño *f* 72
Algeria 317
algodón *m* 184, 277
alguacil *m* 180
alhelí *m* 110
allicatar 82
alicates *m* 80
alimentos *m* 118, 130
alimentos embotellados *m* 134
aliñado 159
aliño *m* 158
alisar 39, 79
almacén *m* 216
almanaque *m* 306
almeja *f* 121
almendra *f* 122, 129
almendras *f* 151
almohada *f* 70
almohadilla *f* 15
almohadilla de la tinta *f* 173
alquilar 58
alquiler *m* 58
alquiler de coches *m* 213
alrededor de 320
alta definición 269
altavoz *m* 176, 258, 268
alternador *m* 203
altitud *f* 211
alto 321
altura *f* 165
alubia blanca *f* 131
alubia blanca pequeña *f* 131
alubia de ojo negro *f* 131
alubia flageolet *f* 131
alubia morada *f* 131
alubia mung *f* 131
alubia pinta *f* 131
alubia roja *f* 131
alubias *f* 131
aluminio *m* 289
alumno *m* 162
amanecer *m*
amapola *f* 297
amargo 124, 127
amarillo 274
amarrar 217
amasar 138
amatista *f* 288
Amazonas *m* 312
ambulancero *m* 94
ambulancia *f* 94
América del Norte y Central 314
americana *f* 33
amigo *m* 24
amigo por correspondencia *m* 24
amniocentesis *f* 52
amperio *m* 60
ampliación *f* 58, 271
ampliar 172
amplificador *m* 268
ampolla *f* 46
anacardo *m* 129
anacardos *m* 151
analgésico *m* 109
analgésicos *m* 47
análisis *m* 49
análisis de sangre *m* 48
análogo 179
ancho 321
anchura *f* 165
ancla *f* 214, 240
andamio *m* 186
andén *m* 208
Andes *m* 312
Andorra 316
anestésista *m/f* 48
anfibios *m* 294
anfiteatro *m* 169
anfitrión *m* 64
anfitriona *f* 64
Angola 317
anguila *f* 294
ángulo *m* 164
anillas *f* 89, 235
anillo *m* 36
animadora *f* 220
animales *m* 292, 294
anis estrellado *m* 133
aniversario *m* 26
anochecer *m* 305
antebrazo *m* 12
antecedentes *m* 181
antena *f* 295
antena de radio *f* 214
antena parabólica *f* 269
antes 320
antes de 320
antes de ayer 307
antiadherente 69
antiarrugas 41
anticoncepción *f* 21, 52
anticongelante *m* 199, 203
Antigua y Barbuda 314
antiinflamatorio *m* 109

- anual 86, 307
 anular *m* 15
 anuncio *m* 269
 anzuelo *m* 244
 año *m* 306
 Año Nuevo *m* 27
 apagado 99
 apagar 141
 apagar la televisión 269
 apaisado 271
 aparato corrector *m* 50
 aparatos eléctricos *m* 105
 aparcamiento *m* 298
 aparcamiento para minusválidos *m* 195
 aparcar 195
 aparejos *m* 245
 apelación *f* 181
 apéndice *m* 18
 aperitivo *m* 153
 aperitivos *m* 151
 ápice *m* 165
 apio *m* 122
 apio-nabo *m* 124
 apisonadora *f* 187
 aplaudir 255
 aplicación *f* 99, 176
 aplique *m* 62
 apoyabrazos *m* 210
 aprender 163
 apuesta *f* 273
 apuntalar 91
 aquijón *m* 295
 Arabia Saudita 318
 arándano *m* 127
 arándano rojo *m* 127
 arandela *f* 80
 araña *f* 295
 arañazo *m* 46
 arar 183
 árbitro *m* 222, 225, 226, 229
 árbol *m* 86, 296
 arbusto de flor *m* 87
 arce *m* 296
 arcén *m* 194
 archivador *m* 172
 archivador suspendido *m* 173
 arcilla *f* 85, 275
 arco *m* 85, 164, 249, 301
 arco del empuje *m* 15
 arcoiris *m* 287
 ardilla *f* 290
 área *f* 165, 310
 área de juegos *m* 263
 área de meta *f* 223
 área de penalty *f* 223
 arena *f* 85, 264
 arenques ahumados *m* 157
 argamasa *f* 187
 Argentina 315
 aritmética *f* 165
 armario *m* 66, 70
 armario de las medicinas *m* 72
 armario empotrado *m* 71
 armario para clasificar la basura *m* 61
 armazón *m* 230
 Armenia 318
 aro *m* 226
 aromaterapia *f* 55
 arquitecto *m* 190
 arquitectura *f* 300
 arquitrabe *m* 301
 arrancar 82
 arrecife de coral *m* 285
 arreglos *m* 111
 arresto *m* 94
 arriate de plantas herbáceas *m* 85
 arriba 320
 arroyo *m* 285
 arroz *m* 130, 158, 184
 arroz bomba *m* 130
 arroz con leche *m* 140
 arroz integral *m* 130
 arroz largo *m* 130
 arroz salvaje *m* 130
 arruga *f* 15
 art déco 301
 arte *m* 162
 arteria *f* 19
 artes marciales *f* 237
 articulación *f* 17
 artículos de aseo *m* 107
 artículos de tocador *m* 41
 artículos deportivos *m* 105
 artículos para el bebé *m* 107
 as *m* 230, 273
 asa *f* 88, 106
 asa *m* 36
 asado *m* 119, 158
 asalto *m* 237
 asar 67
 asar a la parrilla 67
 asas *f* 37
 ascensor *m* 59, 100, 104
 aseos *m* 104, 266
 asesora financiera *f* 97
 asesoría jurídica *f* 180
 asfalto *m* 187
 Asia 318
 asiento *m* 64, 204, 209, 210
 asiento del conductor *m* 196
 asiento trasero *m* 200, 204
 asistir 174
 asma *m* 44
 aspa *f* 211
 aspecto *m* 30
 aspersor *m* 89
 aspiradora *f* 77, 188
 asta *f* 291
 asteroide *m* 280
 astigmatismo *m* 51
 astilla *f* 46
 astillero *m* 217
 astronauta *m* 281
 astronomía *f* 281
 asustado 25
 ataque *m* 220
 atasco de tráfico *m* 195
 aterrizar 211
 ático *m* 58
 atleta *f* 234
 atletismo *m* 234
 atmósfera *f* 282, 286
 atracar 217
 atracción turística *f* 260
 atrio *m* 104
 atún *m* 120
 auditor *m* 180
 aula *f* 162
 auricular *m* 99
 auriculares *m* 268
 aurora *f* 286
 Australasia 319
 Australia 319
 Austria 316
 autobús *m* 196
 autobús de dos pisos *m* 196
 autobús de enlace *m* 197
 autobús escolar *m* 196
 autobús turístico *m* 197, 260
 autobuses *m* 196
 autocar *m* 196
 autocue *m* 179
 automático 200
 automovilismo *m* 249
 autopista *f* 194
 autovia *f* 195
 avalancha *f* 247
 avance rápido *m* 269
 avellana *f* 129
 avena *f* 130
 avenida *f* 299
 avergonzado 25
 avería *f* 203
 aves *f* 292
 avestruz *f* 292
 avión *m* 210
 avión de línea *m* 212
 avión de pasajeros *m* 210
 avioneta *f* 211
 avispa *f* 295
 axila *f* 13
 ayer 306
 ayudante *f* 24
 ayudante del chef *m* 152
 ayurveda *f* 55
 azabache *m* 288
 azada *f* 88
 azafata *f* 190
 azafata de vuelo *f* 210
 azafrán *m* 132
 Azerbaiyán 318
 azucena *f* 110
 azufre *m* 289
 azul 274
 azul añil 274
B
 babero *m* 30
 babosa *f* 295
 baca *f* 198
 baca para bicicletas *f* 207
 bacalao *m* 120
 backgammon *m* 272
 backswing *m* 233
 bacon *m* 118, 157
 bádminton *m* 231
 baguette *f* 138
 Bahamas 314
 Bahrein 318
 bailarina *f* 37, 191
 bajar 177
 bajo 320, 321
 bajo par *m* 233
 bala *f* 184
 balancín *m* 263
 balanza *f* 310
 balanza de cocina *f* 69
 balanza de muelle *f* 166
 balcón *m* 59
 baliza *f* 298
 ballena *f* 290
 ballet *m* 255
 balón *m* 220, 221, 222, 226
 baloncesto *m* 226
 balonvolea *m* 227
 balsa salvavidas *f* 240
 bambú *m* 86, 122
 banco 96, 250, 262
 banco de trabajo *m* 78
 banda de paseo *f* 250
 banda de rodadura *f* 207
 banda sonora *f* 255
 bandeja *f* 152, 154, 210, 310
 bandeja de entrada *f* 172, 177
 bandeja de horno *f* 69
 bandeja de salida *f* 172
 bandeja del desayuno *f* 101
 bandeja para el papel *f* 172
 bandeja para la pintura *f* 83
 bandera *f* 221
 bandera de esquina *f* 223
 banderola *f* 232
 Bangladesh 318
 banquillo *m* 229
 bañador *m* 238, 265
 bañera *f* 72
 bañera de plástico *f* 74
 bar *m* 148, 150, 152
 bar mitzvah *m* 26
 baraja de cartas *f* 273
 barajar 273
 barandilla *f* 59, 196
 barbacoa *f* 267
 Barbados 314
 barbero *m* 39, 188
 barbilla *f* 14
 barca de remos *m* 214
 barco *f* 214
 barco de vela *m* 215
 barco de guerra *m* 215
 barco de pesca *m* 217
 barniz *m* 79, 83
 barra *f* 139, 150, 250, 256
 barra de acceso *f* 177
 barra de desplazamiento *f* 177
 barra de equilibrio *f* 235
 barra de labios *f* 40
 barra de pesas *f* 251
 barra del menú *f* 177
 barra fija *f* 235
 barrer 77
 barrera *f* 209, 222
 barrera contra el viento *f* 265
 barrera de seguridad *f* 75, 195, 246
 barrita *f* 113
 barroco 301
 barrotes *m* 74
 basalto *m* 288
 báscula *f* 45, 53, 69, 98, 166
 base *f* 99, 164, 229
 base *m* 228
 base del bateador *f* 228
 bastidor *m* 277
 bastidores *m* 254
 bastón *m* 246
 bata *f* 31, 32, 35, 38
 bate *m* 225, 228
 bateador *m* 225, 228
 batear 225, 229
 batería *f* 78, 202, 258
 batería *m* 258
 batido *m* 137
 batido al café *m* 149
 batido de chocolate *m* 149
 batido de fresa *m* 149
 batidor de varillas *m* 68
 batir 67
 batir un récord 234
 batuta *f* 256
 bautizo *m* 26
 baya *m* 296
 bazo *m* 18
 bebé *m* 23, 30
 bebida malteada *f* 144
 bebidas *f* 144, 107, 156
 bebidas alcohólicas *f* 145
 bebidas calientes *f* 144
 beca *f* 169
 béisbol *m* 228
 Belarús 316
 Bélgica 316
 Belice 314
 belleza *f* 40
 bemol 256
 bengala *f* 240
 Benin 317
 berberecho *m* 121
 berenjena *f* 125

- berro *m* 123
 berza *f* 123
 besugo *m* 120
 Bhutan 318
 biatlón *m* 247
 biberón *m* 75
 biblioteca *f* 168, 299
 bibliotecaria *f* 168
 bibliotecario *m* 190
 bíceps *m* 16
 bicicleta *f* 206
 bicicleta de carreras *f* 206
 bicicleta de montaña *f* 206
 bicicleta de paseo *f* 206
 bicicleta fija *f* 250
 bidé *m* 72
 bienal 86
 bifocal 51
 bigotes *m* 290
 bikini *m* 264
 billar *m* 249
 billar americano *m* 249
 billete *m* 97, 209, 213
 billete de autobús *m* 197
 billetes de lotería *m* 112
 biología *f* 162
 biológico 91, 118, 122
 biplano *m* 211
 Birmania 318
 bis *m* 255
 biscote *m* 139
 bisturí *m* 167
 blanco 39, 145, 272, 274
 blando 129, 321
 bloc de apuntes *m* 173
 bloc de dibujo *m* 275
 bloque de hormigón *m* 187
 bloquear 227
 blues *m* 259
 blusa *f* 34
 bobina *f* 276
 bobsleigh *m* 247
 boca *f* 14
 boca de agua *f* 95
 boca de alcantarilla *f* 299
 bocadillo *m* 155
 bocado *m* 242
 boceto *m* 275
 bocina *f* 201
 boda *f* 26, 35
 bodega *f* 215
 body *m* 30
 bol *m* 65
 bola *f* 149
 bola de bowling *f* 249
 bolas de algodón *f* 41
 bolígrafo *m* 163
 bolillo *m* 277
 Bolivia 315
 bollo *m* 139, 140, 155
 bolo *m* 249
 bolos *m* 249
 bolsa *f* 291, 311
 bolsa de agua caliente *f* 70
- bolsa de golf *f* 233
 bolsa de la compra *f* 106
 bolsa de plástico *f* 122
 bolsa de playa *f* 264
 bolsa de valores *f* 97
 bolsa de viaje *f* 37
 bolsa del bebé *f* 75
 bolsa para la hierba *f* 88
 bolsillo *m* 32
 bolsita de té *f* 144
 bolso *m* 37
 bolso de mano *m* 37
 bolsos *m* 37
 bomba *f* 207
 bombardero *m* 211
 bombero *m* 189
 bomberos *m* 95
 bombilla *f* 60
 bombilla de ahorro de energía *f* 60
 bombón *m* 113
 bongos *m* 257
 boniato *m* 125
 boquilla *f* 89
 bordado *m* 277
 bordado en cañamazo *m* 277
 borde del ocular *m* 269
 bordillo *m* 298
 borla *f* 40
 borrén *m* 242
 Bosnia y Herzegovina 316
 bosque *m* 285
 bostezar 25
 bota *f* 37, 220, 223
 bota de esquí *f* 246
 bota de montar *f* 242
 bota de trekking *f* 37
 botar 227
 botas altas de goma *f* 244
 botas de agua *f* 31
 botas de goma *f* 89
 botas de trekking *f* 267
 botavara *f* 240
 bote salvavida *m* 214
 botella *f* 61, 135, 311
 botella de aire *f* 239
 botella del agua *f* 206
 botiquín *m* 47
 botón *m* 32
 botón de ajuste *m* 167
 botón de parada *m* 197
 botón para grabar *m* 269
 botón para rebobinar *m* 269
 botones *m* 100
 Botswana 317
 boutique *f* 115
 bóveda *f* 300
 boxeo *m* 236
 boya *f* 217
 bragas *f* 35
 braguitas de plástico *f* 30
 Brasil 315
- braza *f* 239
 brazada *f* 239
 brazal *m* 45
 brazo *m* 13, 95
 brezo *m* 297
 brida *f* 242
 bridge *m* 273
 brie *m* 142
 brillo de labios *m* 40
 brillo del sol *m* 286
 broca *f* 78
 broca de albañilería *f* 80
 broca de seguridad *f* 80
 broca para madera *f* 80
 broca para metal *f* 80
 brocas *f* 80
 brocas para madera *f* 80
 brocha *f* 40, 83
 brocha de cocina *f* 69
 brocha de empapelador *f* 82
 brocha de encolar *f* 82
 broche *m* 36
 brócoli *m* 123
 bronce *m* 235
 bronceado *m* 41
 brotes de soja *m* 122
 brújula *f* 240, 312
 Brunei 319
 buceo *m* 239
 buenas noches 322
 buenas tardes 322
 bueno 321
 buenos días 322
 bufanda *f* 31
 bufete *m* 180
 buffet *m* 152
 buffet de desayuno *m* 156
 buggy *m* 232
 búho *m* 292
 bujía *f* 203
 bulbo *m* 86
 Bulgaria 316
 búnker *m* 232
 buque de carga *m* 215
 buque portacontenedores *f* 215
 Burquina Faso 317
 burro *m* 185
 Burundi 317
 buscar 177
 butaca *f* 254
 butacas *f* 254
 buzo *m* 30
 buzón *m* 58, 99
 bytes *m* 176
- C**
 caballa *f* 120
 caballete *m* 174, 274
 caballito de mar *m* 294
 caballo *m* 185, 235, 242, 272
 caballo con arcos *m* 235
 caballo de carreras *m* 243
- cabecero *m* 70
 cabestrillo *m* 46
 cabestro *m* 243
 cabeza *f* 12, 19, 81, 230
 cabezal *m* 78
 cabezales de destornillador *m* 80
 cabezuela *f* 122
 cabina *f* 95, 210
 cabina de pilotaje *f* 210
 cabina del conductor *f* 208
 cabina telefónica *f* 99
 Cabinda 317
 cable *m* 79, 207
 cable de alimentación *m* 176
 cables *m* 60
 cabra *f* 185
 cabrestante *m* 214
 cabrito *m* 185
 cacahuete *m* 129
 cacahuetes *m* 151
 cacao *m* 156
 cacao en polvo *m* 148
 cacatúa *f* 293
 cachorro *m* 290
 cactus *m* 87
 caddy *m* 233
 cadena *f* 36, 59, 206
 cadena montañosa *f* 282
 cadera *f* 12
 café *m* 144, 148, 153, 156, 184
 café con hielo *m* 148
 café con leche *m* 148
 café de cafetera eléctrica *m* 148
 café molido *m* 144
 café solo *m* 148
 cafetera de émbolo *f* 65
 cafetería *f* 148, 262
 cafetería con mesas fuera *f* 148
 caída *f* 237
 caimán *m* 293
 caja *f* 106, 150
 caja archivador *f* 173
 caja de aparejos *f* 244
 caja de bombones *f* 113
 caja de cambios *f* 202, 204
 caja de fusibles *f* 203
 caja de herramientas *f* 80
 caja de los fusibles *f* 60
 caja de pañuelos de papel 70
 caja para cortar en inglete *f* 81
 caja torácica *m* 17
 cajero *m* 96, 106
 cajero automático *m* 97
 cajón *m* 66, 70, 172
 cajón de las verduras *m* 67
 cajón de salida *m* 234, 238
- calabacín *m* 125
 calabacín gigante *m* 124
 calabaza *f* 125
 calabaza bellota *f* 125
 calamar *m* 121, 295
 calambres *m* 44
 calcetines *m* 33
 calcio *m* 109
 calcita *f* 289
 calculadora *f* 165
 caldera *f* 61
 caldo *m* 158
 calentador de convección *m* 60
 cálido 286
 caliente 321
 cáliz *m* 297
 calle *f* 232, 234, 238, 298
 calle de sentido único *f* 298
 calle lateral *f* 299
 callejón *m* 298
 calmante *m* 109
 caluroso 286
 calvo 39
 calzapié *m* 207
 calzoncillos *m* 33
 calzoncillos de pata *m* 33
 cama *f* 70
 cama de matrimonio *f* 71
 cama de rayos ultravioletas *f* 41
 cama individual *f* 71
 cámara *f* 178, 207, 283
 cámara *m* 178
 cámara de vídeo *f* 260, 269
 cámara desechable *f* 270
 cámara digital *f* 270
 cámara Polaroid *f* 270
 cámara réflex *f* 270
 camarera *f* 191
 camarero *m* 148, 150, 152, 191
 camarote *f* 214
 cambiador *m* 74
 cambiar 209
 cambiar de canal 269
 cambiar de marcha 207
 cambiar una rueda 203
 Camboya 318
 camello *m* 291
 camembert *m* 142
 Camerún 317
 camilla *f* 48, 94
 camino *m* 58, 85
 camión *m* 194
 camión volquete *m* 187
 camionero *m* 190
 camisa *f* 33
 camiseta *f* 33, 54, 251
 camiseta de tirantes *f* 35
 camiseta interior *f* 33
 camisola *f* 35

- camisón *m* 31, 35
 campari *m* 145
 campeonato *m* 230
 cámpfer *f* 266
 camping *m* 268
 campo *m* 182, 220, 222, 225, 228, 234
 campo de críquet *m* 225
 campo de deportes *m* 168
 campo de golf *m* 232
 campo de rugby *m* 221
 campus *m* 168
 Canadá 314
 canal *m* 178, 269
 canal de pay per view *m* 269
 canalón *m* 58
 canario *m* 292
 canasta *f* 226
 cancha *f* 226
 canción *f* 259
 candado *m* 207
 canela *f* 133
 cangrejo *m* 121, 295
 cangrejo de río *m* 121
 canguro *m* 291
 canoa *f* 214
 cantante *m* 258
 cantante *f* 191
 cantidad *f* 96
 cantimplora *f* 267
 canto *m* 246
 caña *f* 91
 caña de azúcar *f* 184
 caña de pescar *f* 244
 caña del timón *f* 240
 cañas *f* 89
 capa de ozono *f* 286
 capa superior de la tierra *f* 85
 capacidad *f* 311
 caparazón *m* 293
 capazo *m* 75
 capital *f* 315
 capitán *m* 214
 capitán del puerto *m* 217
 capó *m* 198
 capoeira *f* 237
 capota *f* 75
 cápsula *f* 109
 cápsula de Petri *f* 166
 captafaros *m* 204, 207
 capuccino *m* 148
 capucha *f* 31
 capullo *m* 111, 295, 297
 caqui *m* 128
 cara *f* 14
 carabola *f* 128
 caracol *m* 295
 carámbano *m* 287
 caramelo *m* 113
 caramelo blando *m* 113
 caramelos *m* 113
 caramelos duros *m* 113
 carbón *m* 288
 carbón vegetal *m* 266
 carboncillo *m* 275
 carcaj *m* 249
 cárcel *f* 181
 cardamomo *m* 132
 cardiología *f* 49
 cardiovascular 19
 cardo *m* 297
 careta *f* 236
 carga *f* 216
 cargar 76
 cargo *m* 94, 180
 caries *f* 50
 carnaval *m* 27
 carne *f* 119
 carne blanca *f* 118
 carne de caza *f* 119
 carne de vaca *f* 118
 carne fresca *f* 142
 carne magra *f* 118
 carne picada *f* 119
 carne roja *f* 118
 carne y las aves *f* 106
 carnicería *f* 114
 carnicero *m* 118, 188
 carpa koi *f* 294
 carpeta *f* 172, 177
 carpeta de acordeón *f* 173
 carpeta de anillas *f* 173
 carpintero *m* 188
 carrera *f* 169, 228, 234
 carrera al trote *f* 243
 carrera de caballos *f* 243
 carrera de carrozas *f* 243
 carrera de motoras *f* 241
 carrera de obstáculos *f* 243
 carrera de relevos *f* 235
 carrera de vallas *f* 235
 carrera sin obstáculos *f* 243
 carrete *m* 244, 245, 271
 carrete de hilo *m* 276
 carretera de acceso *f* 216
 carreteras *f* 194
 carretilla *f* 88
 carretilla elevadora *f* 186, 216
 carril central *m* 194
 carril de adelantamiento *m* 194
 carril de bicicletas *m* 206
 carril para el tráfico lento *m* 194
 carrito *m* 100, 208
 carrito de golf *m* 233
 carrito de los postres *m* 152
 carro *m* 106, 213
 carta *f* 98, 148, 153
 carta por avión *f* 98
 cartas *f* 273
 cartera *f* 37, 97, 162, 190
 cartero *m* 98, 190
 cartílago *m* 17
 cartón de leche *m* 136
 cartón madera *m* 79
 cartulina *f* 275
 carvi *m* 131
 casa *f* 58
 casa de juguete *f* 75
 casa de labranza *f* 182
 casa de muñecas *f* 75
 casarse 26
 cascada *f* 285
 cáscara *f* 129, 130, 137
 casco *m* 95, 186, 204, 206, 214, 220, 224, 228, 240, 242
 caseta *f* 264
 caseta de peaje *f* 194
 casete *f* 269
 casilla *f* 100, 272
 casino *m* 261
 caspa *f* 39
 castaña *f* 129
 castaña de agua *f* 124
 castaño 39
 castillo *m* 300
 castillo de arena *m* 265
 catamarán *m* 215
 catarata *f* 51
 catcher *m* 229
 catedral *f* 300
 catéter *m* 53
 catorce 308
 catre de campaña *m* 266
 cavar 90
 caza *m* 211
 cazo *m* 69
 cazoleta *f* 112
 cazuela *f* 69
 cazuela de barro *f* 69
 cebada *f* 130, 184
 cebar 245
 cebo *m* 244
 cebolla *f* 124
 cebolleta *f* 125
 cebollinos *m* 133
 cebra *f* 291
 cedro *m* 296
 ceja *f* 14, 51
 celda *f* 94, 181
 celebración *f* 140
 celebración de la boda *f* 26
 celebraciones *f* 27
 cemento *m* 186
 cemento blanco *m* 83
 cena *f* 64
 cenicero *m* 150
 ceniza *f* 283
 centésimo 309
 centímetro *m* 310
 centrifugadora *f* 76
 centrifugar 76
 centro *m* 122, 164
 centro comercial *m* 104
 centro de la diana *m* 273
 centro de salud *m* 168
 centro del campo *m* 228
 ceño fruncido *m* 25
 cepillar 38
 cepillarse los dientes 50
 cepillo *m* 38, 77, 81
 cepillo de dientes *m* 72
 cepillo para la espalda *m* 73
 cepillo para las cejas *m* 40
 cera *f* 77
 cerámica *f* 275
 cerca 320
 cerca *f* 182
 cercado *m* 242
 Cerdeña 316
 cerdito *m* 185
 cerdo *m* 118, 185
 cereales *m* 107, 130, 156
 cerebro *m* 19
 ceremonia de graduación *f* 169
 cereza *f* 126
 cero 308
 cerrado 260, 321
 cerradura *f* 59
 cerrojo *m* 59
 cerveza *f* 145, 151
 cerveza amarga *f* 145
 cerveza negra *f* 145
 cesárea *f* 52
 césped *m* 85, 86, 90
 cesta *m* 263
 cesta *f* 95, 106, 207
 cesta colgante *f* 84
 cesta de fruta *f* 126
 cesta de jardinero *f* 88
 cesto de la colada *m* 76
 cesto de la ropa sucia *m* 76
 cesto de los juguetes *m* 75
 ceta *f* 85
 Chad 317
 chaleco *m* 33
 chaleco salvavidas *m* 240
 chalote *m* 125
 champán *m* 145
 champanera *f* 150
 champiñón *m* 125
 champú *m* 38
 chancla *f* 37
 chándal *m* 31, 32
 chapa *f* 202
 chaqueta *f* 32, 34
 chaqueta da esquí *f* 246
 chaqueta sport *f* 33
 chaquetón *m* 31, 33
 charcutería *f* 107, 142
 chasis *m* 203
 cheddar *m* 142
 chef *m* 152, 190
 cheque *m* 96
 cheque de viaje *m* 97
 chica *f* 23
 chichonera *f* 74
 chicle *m* 113
 chico *m* 23
 Chile 315
 chimenea *f* 58, 63, 214, 283
 China 318
 chincheta *f* 173
 Chipre 316
 chirivía *f* 125
 chocolate blanco *m* 113
 chocolate caliente *m* 144
 chocolate con leche *m* 113
 chocolate negro *m* 113
 chocolate para untar *m* 135
 chorizo *m* 143
 chorro de agua *m* 95
 chubasco *m* 286
 chuleta *f* 119
 chutar 221, 223
 chutney *m* 134
 ciclismo *m* 263
 ciempiés *m* 295
 cien 308
 cien mil 308
 ciencias *f* 162, 166
 ciencias económicas *f* 169
 cieno *m* 85
 científico *m* 190
 ciento diez 308
 cierre *m* 36, 37
 cierre de seguridad *m* 75
 ciervo *m* 291
 cigarrillos *m* 112
 cigüeña *f* 292
 cilantro *m* 133
 cilindro *m* 164
 cincel *m* 81, 275
 cincha *f* 242
 cinco 308
 cincuenta 308
 cincuenta mil 309
 cincuenta y cinco mil quinientos 309
 cine *m* 255, 299
 cinta *f* 27, 111, 141, 235
 cinta adhesiva protectora *f* 83
 cinta aislante *f* 81
 cinta de equipajes *f* 212
 cinta de vídeo *f* 269
 cinta métrica *f* 80, 276
 cinta para el pie *f* 241
 cinta reflectante *f* 205
 cinta transportadora *f* 106
 cintura *f* 12
 cinturilla *f* 35
 cinturón *m* 32, 36, 236
 cinturón de las herramientas *m* 186
 cinturón de pesas *m* 239
 cinturón de seguridad *m* 198, 211
 cinturón negro *m* 237
 círculo *m* 165

- círculo central *m* 222, 224, 226
 círculo de face-off *m* 224
 círculo Polar Ártico *m* 283
 circunferencia *f* 164
 ciruela *f* 126
 ciruela pasa *f* 129
 cirugía *f* 48
 cirugía plástica *f* 49
 cirujano *m* 48
 cisne *m* 293
 cisterna *f* 61
 cita *f* 45, 175
 citación *f* 180
 cítricos *m* 126
 citronela *f* 133
 ciudad *f* 298, 299
 Ciudad del Vaticano 316
 cizalla *f* 89
 claqueta *f* 179
 clara *f* 137
 clarinete *m* 257
 clarinete bajo *m* 257
 claro 41, 321
 clase preferente *f* 211
 clase turista *f* 211
 clavar con el martillo 79
 clave de acceso *f* 99
 clave de fa *f* 256
 clave de sol *f* 256
 clavel *m* 110
 clavícula *f* 17
 clavija *f* 60, 259, 266
 clavo *m* 80
 clavos *m* 133, 233
 claxon *m* 204
 cliente *m* 96, 104, 106, 152, 180
 clienta *f* 38, 175
 clínica *f* 48
 clip *m* 173
 clítoris *m* 20
 club *m* 232
 club sandwich *m* 155
 cobertizo *m* 84, 182
 cobrar 97
 cobre *m* 289
 cocer a fuego lento 67
 cocer al horno 67
 cocer al vapor 67
 coche *m* 198, 200
 coche de bomberos *m* 95
 coche de cinco puertas *m* 199
 coche de época *m* 199
 coche de policía *m* 94
 coche deportivo *m* 198
 coche descapotable *m* 199
 coche eléctrico *m* 199
 coche ranchera *m* 199
 cochecama *m* 209
 cochecito de niños *m* 75
 cocido en el horno 159
 cocina *f* 66, 152, 214
 cocinar 67
 coco *m* 129
 cocodrilo *m* 293
 cóctel *m* 151
 coctelera *f* 150
 código de barras *m* 106
 código postal *m* 98
 codo *m* 13
 codorniz *f* 119
 coger 91, 220, 227, 229, 245
 coger con la red 245
 coger prestado 168
 coito *m* 20
 cojin *m* 62
 col *f* 123
 col rizada *f* 123
 cola *f* 35, 121, 144, 210, 242, 275, 280, 290, 294
 cola de caballo *f* 39
 cola de carpintero *f* 78
 cola para empapelar *f* 82
 colada *f* 76
 colador *m* 68
 colcha *f* 70, 71
 colchón *m* 70, 74
 colchoneta *f* 54, 235, 267
 colegial *m* 162
 colegiala *f* 162
 colegio *m* 162, 299
 colegio mayor *m* 168
 coles de bruselas *f* 122
 coletas *f* 39
 colgante *m* 36
 colibrí *m* 292
 coliflor *f* 124
 colina *f* 284
 colinabo *m* 123
 collage *m* 275
 collar *m* 36
 collar de perlas *m* 36
 collarín *m* 46
 colmillo *m* 50, 291
 Colombia 315
 colonia *f* 315
 colores *m* 39, 274
 colorete *m* 40
 columna *f* 300
 columpios *m* 263
 colza *f* 184
 comadrona *f* 53
 combate *m* 237
 combinación *f* 35
 comedero *m* 183
 comedia *f* 255
 comedor *m* 64
 comer 64
 cometa *m* 280
 comida *f* 64, 75, 149
 comida de negocios *f* 175
 comida para animales *f* 107
 comida principal *f* 158
 comida rápida *f* 154
 comino *m* 132
 comisario *m* 94
 comisión *f* 97
 comisión bancaria *f* 96
 cómo se declara el acusado 180
 cómoda *f* 70
 comodín *m* 273
 Comoros 317
 compact disc *m* 269
 compañero *m* 24
 compañero/-a *m/f* 23
 compartimento del carrete *m* 270
 compartimento portaequipajes *m* 210
 compás *m* 165
 complejo vitamínico *m* 109
 completo 266
 compra *f* 106
 compras *f* 104
 compresa *f* 108
 comunicaciones *f* 98
 comunicando 99
 con 320
 con aros *m* 35
 con brillo 83, 271
 con corriente 60
 con gas 144
 con hielo y limón 151
 con los hombros al aire 35
 con plomo 199
 concebir 20
 concepción *f* 52
 concha *f* 265
 concierto *m* 255, 258
 concierto de rock *m* 258
 concurso *m* 178
 concurso de saltos *m* 243
 condón *m* 21
 conducir 195
 conducto seminal *m* 21
 conductor *m* 196
 conductor de autobús *m* 190
 conectar 177
 conejo *m* 118, 290
 conexión *f* 212
 confitería *f* 107, 114
 confituras *f* 134
 confuso 25
 congelado 121, 124
 congelador *m* 67
 congelados *m* 107
 congelar 67
 conglomerado *m* 288
 Congo 317
 conífera *f* 86
 conmovión *f* 46
 conmutador de luces *m* 201
 cono *m* 164, 187
 conocido *m* 24
 conseguir un trabajo 26
 conservante *m* 83
 conservas *f* 107
 conservatorio *m* 169
 consola *f* 269
 constelación *f* 281
 construcción *f* 186
 construir 186
 consulta *f* 45
 contable *m* 97, 190
 contador de la luz *m* 60
 contar 165
 contenedor *m* 216
 contenedor de la basura *m* 266
 contento 25
 contestador automático *m* 99
 contestar 99, 163
 continente *m* 282, 315
 contrabajo *m* 256, 258
 contracción *f* 52
 contrachapado *m* 79
 contrafagote *m* 257
 contrafuerte *m* 301
 contraventana *f* 58
 control de pasaportes *m* 213
 controles *m* 201, 204, 269
 coñac *m* 145
 copa *f* 152
 copa de vino *m* 65
 copas *f* 150
 copiloto *m* 211
 corazón *m* 18, 119, 127, 273
 corbata *f* 32
 Córcega 316
 corchete *m* 30, 276
 corcho *m* 134
 cordero *m* 118, 185
 cordón umbilical *m* 52
 cordonera *f* 37
 Corea del Norte 318
 Corea del Sur 318
 córneas *f* 51
 córner *m* 223
 cornisa 300
 corno de caza *m* 257
 corno inglés *m* 257
 coro *m* 301
 corona *f* 50, 111
 corral *m* 182
 correa *f* 37
 correa del calzapíe *f* 207
 correa del disco *f* 203
 correa del ventilador *f* 203
 correo certificado *m* 98
 correo electrónico *m* 98, 177
 correr 228
 correr en parada 251
 corriente alterna *f* 60
 corriente continua *m* 60
 corriente eléctrica *f* 60
 corsé *m* 35
 corsé con ligero *m* 35
 cortaalambres *m* 80
 cortacésped *m* 88, 90
 cortar 38, 67, 79, 277
 cortar el césped 90
 cortar las puntas 39
 cortatuberías *m* 81
 cortaúñas *m* 41
 corte *m* 46
 corte de luz *m* 60
 cortes *m* 119
 corteza *f* 126, 127, 136, 139, 142, 282, 296
 cortina *f* 63
 cortina de ducha *f* 72
 corto 33, 130, 151
 cosecha *f* 183
 cosechadora *f* 182
 cosechar 91
 cosechas *f* 184
 coser 277
 costa *f* 285
 Costa de Marfil 317
 Costa Rica 314
 costilla *f* 17, 119
 costillas *f* 155
 costura *f* 34
 costurera *f* 277
 costurero *m* 276
 coxis *m* 17
 cráneo *m* 17
 cráter *m* 283
 crema *f* 109
 crema autobronceadora *f* 41
 crema bronceadora *f* 265
 crema de limón *f* 134
 crema hidratante *f* 41
 crema para la cara *f* 73
 crema para las escoceduras *f* 74
 crema pastelera 140
 crema protectora *f* 108, 265
 crema protectora total *f* 108
 cremallera *f* 277
 crepe *f* 155
 crepes *m* 157
 cría *f* 290
 criba *f* 89
 cribar 91, 138
 crimen *m* 94
 criminal *m* 181
 crin *f* 242
 crin/melena *f* 291
 críquet *m* 225
 crisantemo *m* 110
 crisol *m* 166
 cristal *m* 51
 cristalera *f* 64
 cristaloterapia *m* 55
 Croacia 316
 croissant *m* 156
 crol *m* 239
 cronómetro *m* 166, 234
 cruce *m* 298
 crudo 124, 129
 cuaderno *m* 163, 172
 cuadro *f* 243
 cuadrado *m* 164

- cuadragésimo 309
cuádriceps *m* 16
cuadro *m* 62, 206, 261, 274
cuarenta 308
cuarenta iguales *m* 230
cuarenta minutos 304
cuarto 309
cuarto de baño *m* 72
cuarto de baño privado *m* 100
cuarto de estar *m* 62
cuarto de galón *m* 311
cuarto oscuro *m* 271
cuarto para cambiar a los bebés *m* 104
cuarzo *m* 289
cuatro 308
cuatrocientos 308
Cuba 314
cubierta *f* 206, 214, 240
cubierto *m* 65
cubierto de chocolate 140
cubiertos *m* 64
cúbito *m* 17
cubito de hielo *m* 151
cubo *m* 77, 82, 164, 265
cubo de basura *m* 67
cubo de la basura *m* 61
cubo para reciclar *m* 61
cubrecanapé *m* 71
cubrir la tierra 91
cucaracha *f* 295
cuchara *f* 65
cuchara de madera *f* 68
cuchara de servir *f* 68
cuchara medidora *f* 109
cuchara para helado *f* 68
cuchara sopera *f* 65
cucharilla de café *f* 65, 153
cucharón *m* 68
cuchilla *f* 66, 78
cuchilla de afeitar desechable *f* 73
cuchillo *m* 65
cuchillo de cocina *m* 68
cuchillo de sierra *m* 68
cuello *m* 12, 32
cuello de pico *m* 33
cuello del útero *m* 20
cuello redondo *m* 33
cuello uterino *m* 52
cuenco *m* 69
cuenco mezclador *m* 66
cuenta *f* 152
cuenta corriente *f* 96
cuenta de ahorros *f* 97
cuenta de correo *f* 177
cuentagotas *m* 109, 167
cuentakilómetros *m* 201, 204
cuentarevoluciones *m* 201
- cuerda *f* 230, 248, 256, 258, 266
cuerda de plomada *f* 82
cuerda para tender la ropa *f* 76
cuerdas vocales *f* 19
cuerno *m* 291
cuero cabelludo *m* 39
cuerpo *m* 12
cuerpos geométricos *m* 164
cuervo *m* 292
cueva *f* 284
cuidado de la piel *m* 108
cuidado del bebé *m* 74
cuidado dental *m* 108
cuidar 91
culata *f* 202
culpable 181
cultivador *m* 182
cultivar 91
cumpleaños *m* 27
cuna *f* 74
cuña *f* 37
cuñada *f* 23
cuñado *m* 23
cúpula *f* 300
curado 118, 143, 159
cúrcuma *f* 132
curling *m* 247
curry *m* 158
curry en polvo *m* 132
curso *m* 163
curvo 165
cuscús *m* 130
cúter *m* 80, 82
cutícula *f* 15
cutis *m* 41
- D**
dado de alta 48
dados *m* 272
damas *f* 272
dar 273
dar de comer 183
dar el pecho 53
dar marcha atrás 195
dardos *m* 273
darse un baño 72
darse una ducha 72
dársena *f* 216
dátil *m* 129
de 320
de cristal 69
de cuatro puertas 200
de fácil cocción 130
de granja 118
de hoja caduca 86
de hoja perenne 86
de mucho viento 286
de nada 322
de preparación al parto 52
de sentido único 194
de temporada 129
de tres puertas 200
de vestir 34
- debajo de 320
deberes *m* 163
débil 321
década *f* 307
décimo 309
décimo noveno 309
décimo octavo 309
decimocuarto 309
decimoquinto 309
decimoséptimo 309
decimosexto 309
decimotercero 309
declaración *f* 180
decoración *f* 82, 141
decorado *m* 254
dedal *m* 276
dedalera *f* 297
dedo corazón *m* 15
dedo del pie *m* 15
dedo gordo del pie *m* 15
dedo pequeño del pie *m* 15
defender 229
defensa *m* 223
defensa *f* 181, 220
defensa personal *f* 237
dejada *f* 230
delantal *m* 30, 50, 69
delante de 320
delantero *m* 222
deletrear 162
delfín *m* 290
delgado 321
deltoides *m* 16
denominador *m* 165
dentadura postiza *f* 50
dentista *f* 189
dentista *m* 50
dentro 320
dentro de 320
denuncia *f* 94
departamento *m* 169
departamento de atención al cliente *m* 175
departamento de contabilidad *m* 175
departamento de marketing *m* 175
departamento de recursos humanos *m* 175
departamento de ventas *m* 175
departamento legal *m* 175
dependienta *f* 188
dependiente *m* 104
depilación a la cera *f* 41
deportes *m* 220, 236, 248
deportes acuáticos *m* 241
deportes de combate *m* 236
deportes de invierno *m* 247
deportista *m* 191
- deportivo 200
depósito del aceite *m* 204
depósito del limpiaparabrisas *m* 202
depósito del líquido de frenos *m* 202
depósito del líquido refrigerante *m* 202
derecha *f* 260
derecho *m* 169, 180, 231
dermatología *f* 49
derrame cerebral *m* 44
derribo *m* 237
desagüe *m* 61, 72
desatascador *m* 81
desayuno *m* 64, 156
desayuno inglés *m* 157
descansillo *m* 59
descanso *m* 223
descarga eléctrica *f* 46
descenso *m* 247
descongelar 67
descorazonador *m* 68
descoser 277
descubierto 260
descubierto *m* 96
desde 320
desechado 129
desechable 109
desembarcar 217
desenfocado 271
desfiladero *m* 284
desfile *m* 27
desierto *m* 285
desinfectante *m* 47
desmayarse 25, 44
desodorante *m* 73
desodorantes *m* 108
despacho *m* 63
despegar 211
desperdicios orgánicos *m* 61
despertarse 71
desplantador *m* 89
después 320
destino *m* 213
destornillador *m* 80
destornillador de estrella *m* 81
desvío *m* 195
detective *m* 94
detector de humos *m* 95
detergente *m* 77
detrás de 320
día *m* 305, 306
día de Acción de Gracias *m* 27
día de Halloween *m* 27
día laborable 304
diabetes *f* 44
diadema *f* 38
diafragma *m* 19, 21
diagonal *f* 164
diamante *m* 288
diámetro *m* 164
- diana *f* 249, 273
diarrea *f* 44, 109
dibujar 162
dibujo *m* 275
dibujos animados *m* 178
diccionario *m* 163
diciembre 306
diecinueve 308
dieciocho 308
dieciséis 308
diecisiete 308
diente *m* 50, 125
diente de la rueda *m* 206
diente de león *m* 123, 297
diesel *m* 199
diez 308
diez mil 309
difícil 321
digestivo 19
digital 179, 269
dilatación *f* 52
Dinamarca 316
dinamo *f* 207
dinero *m* 97
dintel *m* 186
dioptría *f* 51
diploma *m* 169
dique seco *m* 217
dirección *f* 98
dirección de correo electrónico *f* 177
director *m* 163, 174, 254
director de banco *m* 96
director de orquesta *m* 256
director general *m* 175
directorio *m* 104
disco *m* 224
disco de DVD *m* 269
disco duro externo *m* 176
discos protectores *m* 53
discutir 163
diseñador *m* 277
diseñadora *f* 191
diseñar 91
disolvente *m* 83
disparador *m* 270
dispensario *m* 108
dispositivo intrauterino DIU *m* 21
distancia *f* 310
distribuidor *m* 203
distrito *m* 315
dividendos *m* 97
dividido por 165
dividir 165
divisas *f* 97
divisor *m* 173
divorcio *m* 26
Diwali *m* 27
Djibouti 317
dobladillo *m* 34
doble techo *m* 266
doce 308
doctorado *m* 169

- documental *m* 178
 documento adjunto *m* 177
 dolor de cabeza *m* 44
 dolor de estómago *m* 44
 dolor de muelas *m* 50
 doma y monta *f* 243
 domiciliación bancaria *f* 96
 domingo 306
 Dominica 314
 dominó *m* 273
 dormirse 71
 dormitorio *m* 70
 dorsal *m* 16
 dos 308
 dos en punto 304
 dos mil 307
 dos mil uno 307
 doscientos 308
 dosis *f* 109
 drenaje *m* 91
 ducha *f* 72
 duchas *f* 266
 dulce 124, 127, 155
 duodécimo 309
 duodeno *m* 18
 duro 129, 321
- E**
 eccema *m* 44
 echar 67
 eclipse *m* 280
 ecografía *f* 48, 52
 ecuación *f* 165
 Ecuador 315
 ecuador *m* 283
 edificio *m* 59
 edificio de oficinas *m* 298
 edificio de pisos *m* 298
 edificio histórico *m* 261
 edificios *m* 299
 edredón *m* 71
 educación física *f* 162
 efecto *m* 230
 efectos secundarios *m* 109
 Egipto 317
 eje *m* 205, 206
 eje de la transmisión *m* 202
 ejecutivo *m* 174
 ejercicio de bíceps *m* 251
 ejercicios *f* 251
 ejercicios de piernas *m* 251
 ejercicios de suelo *m* 235
 ejercicios pectorales *f* 251
 El Salvador 314
 electricidad *f* 60
 electricista *m* 188
 electrodo negativo *m* 167
 electrodo positivo *m* 167
- electrodomésticos *m* 66, 107
 elefante *m* 291
 eliminación de desechos *f* 61
 embalse *m* 300
 embarazada 52
 embarazo *m* 52
 embarcaciones *f* 215
 embarcadero *m* 217
 embarcar 217
 embrague *m* 200, 204
 embrión *m* 52
 embudo *m* 166
 emigrar 26
 Emiratos Árabes Unidos 318
 emisión *f* 179
 emitir 178
 emociones *f* 25
 empapelar 82
 empaste *m* 50
 empate *m* 223
 empeine *m* 15
 empezar el colegio 26
 empleado *m* 24
 empleado de correos *m* 98
 empleado de la limpieza *m* 188
 empresa *f* 175
 empresaria *f* 24
 en 320
 en aceite 143
 en alfiler 159
 en directo 178
 en diferido 178
 en filetes 121
 en formato vertical 271
 en frente de 320
 en línea 177
 en polvo 77
 en salmuera 143
 en salsa 159
 en vinagre 159
 enamorarse 26
 encaje *m* 35, 80
 encender la televisión 269
 encender una hoguera 266
 encendido *m* 200
 enchufe hembra *m* 60
 enchufe macho *m* 60
 encia *f* 50
 enciclopedia *f* 163
 encima de 320
 encimera *f* 66
 encinta 52
 endibia *f* 122
 endocrino 19
 endocrinología *f* 49
 eneldo *m* 133
 enero 306
 enfadado 25
 enfermedad *f* 44
 enfermedad de transmisión sexual *f* 20
- enfermera *f* 45, 48, 52, 189
 enfocar 271
 enhebrar 277
 enjuagar 38
 enjuague bucal *m* 72
 enrollador de manguera *m* 89
 ensalada *f* 149
 ensalada mixta *f* 158
 ensalada verde *f* 158
 ensayo *m* 221
 enseñanza superior *f* 168
 entarimado *m* 85
 entero 129, 132
 entrada *f* 59
 entrante *m* 153
 entrar en el sistema 177
 entrar en erupción 283
 entre 320
 entrega a domicilio *f* 154
 entrenadora personal *f* 250
 entrenamiento *m* 237
 entrenar 251
 entrevistador *m* 179
 entusiasmado 25
 envenenamiento *m* 46
 enviar 177
 envoltorio *m* 111
 enyesar 82
 epidural *f* 52
 epiglotis *f* 19
 epilepsia *f* 44
 episiotomía *f* 52
 equipaje *m* 100, 198, 213
 equipaje de mano *m* 211, 213
 equipo *m* 205, 220, 229, 233, 238
 equipo de alta fidelidad *m* 268
 equipo de limpieza *m* 77
 equipo de oficina *m* 172
 equitación *f* 242, 263
 Eritrea 317
 erizo *m* 290
 escala *f* 256
 escalada *f* 248
 escalada en hielo *f* 247
 escalera *f* 59, 95, 186
 escalera de mano *f* 82
 escalera mecánica *f* 104
 escalfar 67
 escafo 159
 escalpelo *f* 81
 escama *f* 121, 294
 escamas *f* 293
 escáner *m* 106
 escarabajo *m* 295
 escarcha *f* 287
 escardar 91
 escarificador *m* 80
 escarola *f* 123
 escenario *m* 254
 escoba *f* 77
- escobilla del wáter *f* 72
 escorpión *m* 295
 escota *f* 241
 escotera *f* 240
 escotilla *f* 281
 escribir 162
 escritorio *m* 172, 177
 escroto *m* 21
 escuadra *f* 165
 escucha-bebés *m* 75
 escuela de Bellas Artes *f* 169
 escuelas *f* 169
 escultor *m* 191
 escultura *f* 275
 escurridor *m* 67, 68
 esfera *f* 164
 esgrima *m* 249
 eslabón *m* 36
 Eslovaquia 316
 Eslovenia 316
 esmalte *m* 50
 esmalte de uñas *m* 41
 esmeralda *f* 288
 esófago *m* 19
 espacio *m* 280
 espada *f* 236
 espalda *f* 13, 239
 espaldera *f* 84
 espantapájaros *m* 184
 España 316
 esparadrapo *m* 47
 espárrago *m* 124
 espátula *f* 68, 167
 especialista *m* 49
 especias *f* 132
 espectadores *m* 233
 espejo *m* 40, 71, 167
 espejo retrovisor *m* 198
 esperma *m* 20
 espigón *m* 217
 espina *f* 121
 espina dorsal *f* 17
 espinaca *f* 123
 espinilla *f* 12
 esponja *f* 73, 74, 83
 esponja de luffa *f* 73
 esposas *f* 94
 esprinter *m* 234
 espuma *f* 148
 espuma de afeitar *f* 73
 espumadera *f* 68
 esqueje *m* 91
 esqueleto *m* 17
 esquí *m* 241, 246
 esquí acuático *m* 241
 esquí alpino *m* 247
 esquí de fondo *m* 247
 esquiador acuático *m* 241
 esquiadora *f* 246
 esquina *f* 298
 esquivo *m* 288
 esta semana 307
 estabilizador horizontal *m* 210
 establo *m* 185
 estaca *f* 90
- estación de autobuses *f* 197
 estación de policía *f* 94
 estación de radio *f* 179
 estación de tren *f* 208
 estación espacial *f* 281
 estaciones *f* 306
 estado 223
 estado *m* 315
 Estados Unidos de América 314
 estambre *m* 297
 estanque *m* 67, 85, 106, 232
 estantería *f* 63, 168
 estantes *m* 66
 estaño *m* 289
 estatuilla *f* 260
 este *m* 312
 estéreo 269
 estéril 20, 47
 esterilla *f* 267
 esternón *m* 17
 estetoscopio *m* 45
 estilo modernista *m* 301
 estilos *m* 39, 239, 301
 estilos de jardín *m* 84
 estilos musicales *m* 259
 estiramiento *m* 251
 estirar 251
 estómago *m* 18
 Estonia 316
 estor *m* 63
 estor de láminas *m* 63
 estornudo *m* 44
 estragón *m* 133
 estratosfera *f* 286
 estrecho 321
 estrella *f* 280
 estrella de mar *f* 295
 estreno *m* 254
 estrés *m* 55
 estribo *m* 71, 242
 estructura *f* 267
 estructura para escalar *f* 263
 estuario *m* 285
 estuche *m* 163
 estuche para las lentillas *m* 51
 estudiante *m* 169
 estudio *m* 162
 estudio de grabación *m* 179
 estudio de televisión *m* 178
 estufa *f* 60
 etapas *f* 23
 Etiopía 317
 etiquetas *f* 89
 eucalipto *m* 296
 Europa 316
 examen *m* 163
 examen de ojos *m* 51
 examen médico *m* 45
 excavadora mecánica *f* 187

exceso de equipaje *m* 212
 exfoliar 41
 exósfera *f* 286
 experimento *m* 166
 exploración espacial *f* 281
 exposición *f* 261, 271
 expulsión *f* 223
 extender con el rodillo 67
 exterior *m* 198, 229
 exterior derecho *m* 229
 exterior izquierdo *m* 228
 extintor *m* 95
 extracción *f* 50
 extractor *m* 66

F
 fábrica *f* 299
 fácil 321
 facturar 212
 fagote *m* 257
 faisán *m* 119, 293
 falda *f* 30, 34
 fallo *m* 228
 falsa torre *f* 215
 falta *f* 222, 226, 230
 familia *f* 22
 fans *m* 258
 faringe *f* 19
 farmacéutica *f* 189
 farmacéutico *m* 108
 farmacia *f* 108
 faro *m* 198, 205, 207, 217
 faro trasero *m* 207
 farola *f* 298
 fax *m* 98, 172
 febrero 306
 fecha *f* 306
 fecha de caducidad *f* 109
 fecha de devolución *f* 168
 fecha del juicio *f* 180
 Federación Rusa 318
 feijoa *f* 128
 felpudo *m* 59
 femenino 20
 fémur *m* 17
 feng shui *m* 55
 feria *f* 262
 ferretería *f* 114
 ferry *m* 215, 216
 fertilización *f* 20
 festivos *m* 27
 feto *m* 52
 fiambre *m* 118, 142, 143
 fianza *f* 181
 fibra *f* 127
 fibra natural *f* 31
 ficha *f* 272
 fichero *m* 177
 fideos *m* 158
 fiebre *f* 44
 fiebre del heno *f* 44
 fiesta de cumpleaños *f* 27

Fiji 319
 fila *f* 210, 254
 filamento *m* 60
 filatelia *f* 273
 filete *m* 119, 121
 filete de lomo *m* 119
 filete de solomillo *m* 119
 filetes de mero *m* 120
 Filipinas 319
 filosofía *f* 169
 filtro *m* 270
 filtro de papel *m* 167
 filtro del aire *m* 202, 204
 fin de semana *m* 306
 final *m* 321
 finanzas *f* 97
 Finlandia 316
 firma *f* 96, 98
 firme 124
 física *f* 162, 169
 fisioterapia *f* 49
 flamenco *m* 292
 flanera *f* 69
 flash *m* 270
 flash electrónico *m* 270
 flauta *f* 257
 flautín *m* 257
 flecha *f* 249
 flexión *f* 251
 flexión con estiramiento *f* 251
 flexionar 251
 flor *f* 297
 florentina *f* 141
 flores *f* 110
 flores secas *f* 111
 florete *m* 249
 florista *f* 188
 floristería *f* 110
 florón 300
 flotador *m* 61, 238, 244, 265
 foca *f* 290
 foco *m* 50, 178, 259
 folículo *m* 20
 follaje *m* 110
 folleto *m* 175
 folleto de viajes *m* 212
 folletos *m* 96
 fondere 217
 fondo *m* 177
 fontanería *f* 61
 fontanero *m* 188
 footing *m* 251, 263
 foque *m* 240
 fórceps *m* 53, 167
 forma física *f* 250
 formas *f* 164
 forro *m* 32
 foso *m* 300
 foso de la orquesta *m* 254
 foto *f* 271
 foto (revelada) *f* 271
 fotocopiar 172
 fotofinish *f* 234
 fotografía *f* 270
 fotografiar 271

fotógrafo *m* 191
 fotómetro *m* 270
 fractura *f* 46
 frágil 98
 frambuesa *f* 127
 frambuesa Logan *f* 127
 Francia 316
 franqueo *m* 98
 frasco de cristal *m* 166
 frecuencia *f* 179
 fregadero *m* 66
 fregador *m* 61
 fregar 77
 fregona *f* 77
 freír 67
 frenar 207
 freno *m* 200, 204, 206
 freno de mano *m* 203
 frente *f* 14
 frente de la cocina *m* 66
 fresa *f* 127
 fresco 121, 127, 130
 fresa *f* 110
 friegaplatos *m* 66
 frigorífico *m* 67
 frigorífico congelador *m* 67
 frío 286, 321
 friso *m* 301
 frito 159
 frito con mucho aceite 159
 frito con poco aceite 159
 frontal *m* 16
 frontalería *f* 242
 frontón *m* 300, 301
 fruta *f* 107, 126, 128
 fruta con hueso *f* 126
 fruta desecada *f* 156
 fruta en conserva *f* 134
 fruta escarchada *f* 129
 fruta fresca *f* 157
 frutas tropicales *f* 128
 frutero *m* 188
 fruto del pan *m* 124
 frutos secos *m* 129, 151
 fuente *f* 85, 177
 reloj de sol *m* 262
 fuente para gratinar *f* 69
 fuera 225, 228, 320
 fuera de banda 226
 fuera de juego *m* 223
 fuera de pista 247
 fuerte 321
 full contact *m* 236
 fumar 112
 funcionario de prisiones *m* 181
 funda *f* 51
 funda de la almohada *f* 71
 funda de la cámara *f* 271
 funeral *m* 26
 fuselaje *m* 210
 fusible *m* 60
 fusta *f* 242
 fútbol *m* 222
 fútbol americano *m* 220
 futbolista *m* 222

G
 gabardina *f* 32
 Gabón 317
 gachas de avena *f* 157
 gafas *f* 51, 239, 247
 gafas de natación *f* 238
 gafas de seguridad *f* 81
 gafas de sol *f* 51, 265
 gafas protectoras *f* 167
 gajo *m* 126
 galápagos *m* 293
 galaxia *f* 280
 galería *f* 254
 galleta *f* 113
 galleta de centeno *f* 156
 galletas *f* 141
 gallina *f* 185
 gallinero *m* 185
 gallo *m* 185
 galón *m* 311
 galope *m* 243
 galvanizado 79
 gambas peladas *f* 120
 Gambia 317
 ganado *m* 183, 185
 ganador *m* 273
 ganar 273
 ganchillo *m* 277
 gancho *m* 118, 187
 garaje *m* 58
 garbanzos *m* 131
 garganta *f* 19
 garra *f* 293
 gasa *f* 47
 gasolina *f* 199
 gasolinera *f* 199
 gatito *m* 290
 gato *m* 290
 gaviota *f* 292
 géiser *m* 285
 gel *m* 38, 109
 gel de baño *m* 73
 gel de ducha *m* 73
 gemas *f* 288
 gemelo *m* 36
 gemelos *m* 23
 generación *f* 23
 generador *m* 60
 genitales *m* 12
 gente *f* 12, 16
 geografía *f* 162
 geometría *f* 165
 Georgia 318
 gerbera *f* 110
 Ghana 317
 giba *f* 291
 gimnasia *f* 235
 gimnasia prepugilística *f* 251
 gimnasia rítmica *f* 235
 gimnasio *m* 101, 250
 gimnasta *f* 235
 gin tonic *m* 151
 ginebra *f* 145
 ginecología *f* 49
 ginecólogo *m* 52
 girasol *m* 184, 297
 giro *m* 238

giro postal *m* 98
 glaciario *m* 284
 gladiolo *m* 110
 glándula *f* 19
 glándula del tiroides *f* 18
 glasear 139
 globo *m* 230
 globo aerostático *m* 211
 glorieta *f* 195
 glúteo *m* 16
 gneis *m* 288
 golfes *m* 157
 golf *m* 232
 golondrina *f* 292
 golosinas *f* 113
 golosinas a granel *f* 113
 golpe *m* 233, 237
 golpear 224
 golpes *m* 231
 goma *f* 163
 goma del pelo *f* 39
 goma elástica *f* 173
 gominola *f* 113
 gong *m* 257
 gordo 321
 gorila *m* 291
 gorra *f* 36
 gorra de montar *f* 242
 gorrión *m* 292
 gorro de baño *m* 238
 gorro de cocinero *m* 190
 gorro para el sol *m* 30
 gotas *f* 109
 gotero *m* 53
 gótico 301
 grabado *m* 275
 grabado con antelación 178
 gracias 322
 gráfica del paciente *f* 48
 grafito *m* 289
 grano *m* 310
 Gramada 314
 granada *f* 128
 granate *m* 288
 grande 321
 grandes almacenes *m* 105
 granero *m* 182
 granito *m* 288
 granizo *m* 286
 granja *f* 182, 184
 granja de ganado porcino *f* 183
 granja avícola *f* 183
 granja de frutales *f* 183
 granja de ganado ovino *f* 183
 granja de tierras cultivables *f* 183
 granjero *m* 182
 grano *m* 130
 granos *m* 130, 144
 granos procesados *m* 130
 grapadora *f* 173
 grasas *f* 173
 grasa *f* 119

graso 39, 41
 grava *f* 88
 gravedad *f* 280
 Grecia 316
 green *m* 232
 grifo *m* 61, 66
 grifo de agua caliente *m* 72
 grifo de agua fría *m* 72
 grifo de la cerveza *m* 150
 grillo *m* 295
 gripe *f* 44
 gris 39, 274
 gritar 25
 Groenlandia 314
 grosella blanca *f* 127
 grosella espinosa *f* 127
 grosella negra *f* 127
 grúa *f* 187, 203, 216
 grúa de la cámara *f* 178
 grueso 321
 grulla *f* 292
 guante *m* 224, 228, 233, 236, 246
 guantes *m* 36
 guantes de boxeo *m* 237
 guantes de jardín *m* 89
 guardabarros *m* 205
 guardacostas *m* 217
 guardar 177
 guardia de seguridad *m* 189
 guardián del rastrillo *m* 225
 guarnecedor *m* 88
 Guatemala 314
 guayaba *f* 128
 Guayana Francesa 315
 guía del hilo *f* 276
 guía del viajero *f* 260
 guía turístico *m* 260
 guiar 91
 guimbarda *f* 78
 guindilla *f* 124, 132, 143
 Guineá 317
 Guinea Ecuatorial 317
 Guinea-Bissau 317
 guión *m* 254
 guirnalda *f* 111
 guisante *m* 122
 guisantes *m* 131
 guisantes secos *m* 131
 guisantes tiernos *m* 131
 guiso *m* 158
 guitarra eléctrica *f* 258
 guitarrista *m* 258
 gusano *m* 295
 Guyana 315
 gypsofila 110

H

haba *f* 122
 habas *f* 131
 habitación *f* 58
 habitación con desayuno incluido *f* 101

habitación con dos camas individuales *f* 100
 habitación de los niños *f* 74
 habitación doble *f* 100
 habitación individual *f* 100
 habitación privada *f* 48
 habitaciones *f* 100
 hacer agua 239
 hacer agujeros con la horquilla 90
 hacer amigos 26
 hacer ejercicios de calentamiento 251
 hacer la cama 71
 hacer testamento 26
 hacer un chip 233
 hacer un drive 233
 hacer un pase 223
 hacer un swing 232
 hacer una entrada 223
 hacer una parada 223
 hacha *f* 95
 hacha de cocina *f* 68
 hacia 320
 hacia arriba 98
 haciendo pan 138
 Haití 314
 halcón *m* 292
 hamaca *f* 265, 266
 hambriento 64
 hamburguesa *f* 154
 hamburguesa con patatas fritas *f* 154
 hamburguesa de pollo *f* 155
 hamburguesa vegetariana *f* 155
 hamburguesería *f* 154
 hámster *m* 290
 handicap *m* 233
 hardware *m* 176
 harina blanca *f* 138, 139
 harina con levadura *f* 139
 harina de huesos *f* 88
 harina integral *f* 138
 harina morena *f* 138
 harina para pan *f* 139
 harinas *f* 138
 harpa *f* 256
 hasta 320
 hasta la rodilla 34
 Hawaii 314
 haya *f* 296
 heavy metal *m* 259
 hebilla *f* 36
 hecho puré 159
 helada *f* 287
 helado *m* 137, 149
 helecho *m* 86
 hélice *f* 211, 214
 helicóptero *m* 211
 hematites *m* 289
 hematoma *m* 46
 hemisferio norte *m* 283
 hemisferio sur *m* 283

hemorragia *f* 46
 hemorragia nasal *f* 44
 heno *m* 184
 heno griego *m* 132
 herbicida *m* 91, 183
 herbolario *m* 55
 herboristería *f* 115
 herida *f* 46
 hermana *f* 22
 hermano *m* 22
 herradura *f* 242
 herramienta para modelar *f* 275
 herramientas *f* 187
 herramientas de jardinería *f* 88
 hervidor *m* 66
 hervir a fuego lento 67
 hexágono *m* 164
 hidroavión *m* 211
 hidrodeshlizador *m* 215
 hidroterapia *f* 55
 hielo *m* 120, 287
 hierba *f* 55, 86, 262
 hierbas *f* 133, 134
 hierbas y las especias *f* 132
 hierro *m* 109, 289
 hígado *m* 18, 118
 higiene dental *f* 72
 higiene femenina *f* 108
 higo *m* 129
 higo chumbo *m* 128
 hija *f* 22
 hijastra *f* 23
 hijastro *m* 23
 hijo *m* 22
 hilo *m* 276
 hilo de bramante *m* 89
 hilo de estaño *m* 79, 80
 hilo dental *m* 50, 72
 hilvanar 277
 Himalaya *m* 313
 hinojo *m* 122, 133
 hipermetropía *f* 51
 hipnoterapia *f* 55
 hipoalergénico 41
 hipódromo *m* 243
 hipopótamo *m* 291
 hipoteca *f* 96
 hipotenusa *f* 164
 historia *f* 162
 historia del arte *f* 169
 hocico *m* 293
 hockey *m* 224
 hockey sobre hielo *m* 224
 hockey sobre hierba *m* 224
 hogaza *f* 139
 hoguera *f* 266
 hoja *f* 60, 89, 122, 296
 hoja de afeitar *f* 73
 hoja de ingreso *f* 96
 hoja de reintegro *f* 96
 hojalde *m* 140
 hola 322
 hombre *m* 12, 23

hombre de negocios *m* 175
 hombrera *f* 35, 225
 hombro *m* 13
 homeopatía *f* 55
 homogeneizado 137
 Honduras 314
 hora *f* 304
 hora de dormir *f* 74
 hora punta *f* 209
 horario *m* 197, 209, 261
 horas *f* 261
 horas de visita *f* 48
 horca *f* 88
 hormiga *f* 295
 hormigonera *f* 186
 hormona *f* 20
 hornear 138
 hornillo *m* 267
 horno *m* 66
 horno microondas *m* 66
 horquilla *f* 38, 89, 207
 horrorizado 25
 hospital *m* 48
 hotel *m* 100, 264
 hoy 306
 hoyo *m* 232
 hoyo en uno *m* 233
 hoyuelo *m* 15
 huella dactilar *f* 94
 huerto *m* 85, 182
 hueso *m* 17, 119
 huésped *m* 100
 huevera *f* 65, 137
 huevo de codorniz *m* 137
 huevo de gallina *m* 137
 huevo de oca *m* 137
 huevo de pato *m* 137
 huevo frito *m* 157
 huevo pasado por agua *m* 137, 157
 huevos *m* 137
 huevos revueltos *m* 157
 húmedo 286, 321
 húmero *m* 17
 humo *m* 95
 Hungría 316
 huracán *m* 287

I

icono *m* 177
 idiomas *m* 162
 iglesia *f* 298, 300
 ígneo 288
 igual a 165
 iguana *f* 293
 iluminación *f* 105
 imán *m* 167
 imperdible *m* 47
 impermeable *m* 31
 impotente 20
 impresión *f* 275
 impresora *f* 172, 176
 imprimación *f* 83
 imprimir 172
 impuestos *m* 96
 incendio *m* 95
 incisivo *m* 50

inconsciente 47
 incubadora *f* 53
 India 318
 indicaciones *f* 260
 indicador de la gasolina *m* 201
 indicador de temperatura *m* 201
 indicador de velocidad *m* 201
 indicador para medir la tensión *m* 45
 índice *m* 15
 Indonesia 319
 infarto de miocardio *m* 44
 infección *f* 44
 información *f* 168, 261
 información telefónica *f* 99
 informe *m* 174
 infusión *f* 149
 ingeniería *f* 169
 ingle *f* 12
 ingredientes *m* 155
 ingresado 48
 ingresar 96
 inhalador *m* 44, 109
 injertar 91
 inmigración 212
 inmovilización *f* 237
 inocente 181
 inoculación *f* 45
 inquilino *m* 58
 insomnio *m* 71
 instalaciones internas *f* 60
 instalar 177
 instrumentos *m* 256, 258
 insulina *f* 109
 integral 131
 interceptar *y* devolver 225
 intercostal *m* 16
 interfono *m* 59
 interior *m* 200, 228
 intermitente *m* 198, 204
 internet *m* 177
 interruptor *m* 60
 intestino delgado *m* 18
 intestino grueso *m* 18
 inundación *f* 287
 invernadero *m* 85
 inversión *f* 97
 invertebrados *m* 295
 investigación *f* 94, 169
 invierno *m* 31, 307
 invitado *m* 64
 inyección *f* 48
 iPad *m* 176
 iPod *m* 268
 ionosfera *f* 286
 ir en bicicleta 207
 Irán 318
 Iraq 318
 iris *m* 51, 110
 Irlanda 316
 isla *f* 282

Islandia 316
Islas Baleares 316
Islas Galápagos 315
Islas Salomón 319
Israel 318
Italia 316
itinerario *m* 260
izquierda 260

J
jabón *m* 73
jaboncillo *m* 276
jabonera *f* 73
jade *m* 288
Jamaica 314
jamón *m* 119, 143, 156
jamón serrano *m* 143
Japón 318
jaqueca *f* 44
jarabe *m* 109
jarabe de arce *m* 134
jarabe para la tos *m* 108
jarcias *f* 240
jarcias *f* 215
jardín *m* 84
jardín acuático *m* 84
jardín campestre *m* 84
jardín clásico *m* 84
jardín de plantas herbáceas *m* 84
jardín en la azotea *m* 84
jardinería *f* 90
jardinería *m* 188
jardines *m* 261
jardines clásicos *m* 262
jarra *f* 65, 151
jarra graduada *f* 69, 311
jarrón *m* 63, 111
jazz *m* 259
jefe *m* 24
jengibre *m* 125, 133
jeringuilla *f* 109, 167
jersey *m* 33
jet privado *m* 211
jinete *m* 242
jirafa *f* 179, 291
Jordania 318
jota *f* 273
joyas *f* 36
joyería *f* 114
joyero *m* 36, 188
jubilarse 26
judía verde *f* 122
judo *m* 236
juego *m* 230
juego de dobles *m* 230
juego individual *m* 230
juegos *m* 75, 272
juegos de mesa *m* 272
juegos de raqueta *m* 231
jueves 306
juez *m* 180
juez de línea *m* 220, 223, 230
juez de silla *m* 230
jugador *m* 220, 231, 273
jugador de baloncesto *m* 226

jugador de críquet *m* 225
jugador de hockey sobre hielo *m* 224
jugadora de golf *f* 232
jugar 229, 273
jugoso 127
juguete *m* 75
juguetería *f* 105
juicio *m* 180
julio 306
junco *m* 86
junio 306
junta *f* 61
Júpiter *m* 280
jurado *m* 180

K
K. O. *m* 237
Kaliningrado 316
karate *m* 236
kayak *m* 241
Kazajstán 318
kendo *m* 236
Kenya 317
ketchup *m* 135, 154
kilogramo *m* 310
kilómetro *m* 310
Kirguistán 318
kit de reparaciones *m* 207
kiwi *m* 128
koala *m* 291
Kosovo 316
kumquat *m* 126
kung fu *m* 236
Kuwait 318

L
labio *m* 14
labios *m* 20
labor de encaje *f* 277
labor de punto *f* 277
labor de retales *f* 277
laboratorio *m* 166
laca *f* 38
lacio 39
lacrosse *f* 249
lactancia *m* 53
lácteos *m* 107
lactosa *f* 137
ladera *f* 284
lado *m* 164
ladrillo *m* 187
lagarto *m* 293
lago *m* 285
lágrima *f* 51
laminado 132
lámpara *f* 62, 217
lámpara de la mesilla *f* 70
lana *f* 277
lana de acero *f* 81
lancha motora *f* 214
langosta *f* 121, 295
langostino *m* 121
lanzacohetes *m* 281
lanzador *m* 225
lanzamiento *m* 281
lanzamiento de disco *m* 234

lanzamiento de jabalina *m* 234
lanzamiento de peso *m* 234
lanzar 221, 225, 227, 229, 245
lanzarse 229
Laos 318
lápiz *m* 163, 275
lápiz corrector *m* 40
lápiz de cejas *m* 40
lápiz de colores *m* 163
lápiz de labios *m* 40
lápiz de ojos *m* 40
largo 32, 34, 130, 151
largometraje *m* 269
larguero *m* 222
laringe *f* 19
lata *f* 145, 311
lata de bebida *f* 154
lata de pintura *f* 83
latitud *f* 283
laurel *m* 133
lava *f* 283
lavabo *m* 38, 50, 72
lavadero *m* 76
lavadero de coches *m* 198
lavadora *f* 76
lavadora secadora *f* 76
lavandería *f* 115
lavar 38
laxante *m* 109
lazo *m* 39
lección *f* 163
leche *f* 136, 156
leche condensada *f* 136
leche de cabra *f* 136
leche de oveja *f* 137
leche de vaca *f* 136
leche del cuerpo *f* 73
leche desnatada *f* 136
leche en polvo *f* 137
leche entera *f* 136
leche limpiadora *f* 41
leche semidesnatada *f* 136
lechuga *f* 123
lector de compact discs *m* 268
lector de rayos x *m* 45
leer 162
legumbres *f* 130
lejía *f* 77
lejos 320
lencería *f* 35, 105
lengua *f* 19
lengua *f* 118
lenguado *m* 120
lengueta *f* 37, 244
lente del objetivo *f* 167
lenteja castellana *f* 131
lenteja roja *f* 131
lentes de contacto *f* 51
lentilla *f* 51
lento 321
león *m* 291
león marino *m* 290

leotardos *m* 251
lesión *f* 46
lesión en la cabeza *f* 46
Lesotho 317
Letonia 316
letra *f* 259
letrero *m* 104
levadura *f* 138
levantamiento de pesas *m* 251
levantar 251
levantarse 71
levar 139
Libano 318
libélula *f* 295
Liberia 317
libertad condicional *f* 181
Libia 317
libra *f* 310
libre 321
librería *f* 115
libro *m* 168
libro de texto *m* 163
licencia de pesca *f* 245
licenciada *f* 169
licenciarse 26
lichi *m* 128
licor *m* 145
licuadora *f* 66
Liechtenstein 316
lienzo *m* 274
liga *f* 35, 223
ligamento *m* 17
ligas *f* 35
ligero 321
lijadora *f* 78
lijar 82
lima *f* 81, 126
lima de uñas *f* 41
límite de velocidad *m* 195
limón *m* 126
limonada *f* 144
limousine *f* 199
limpiaparabrisas *m* 198
limpiar 77
limpiar el polvo 77
limpieza de cutis *f* 41
limpio 121
línea central *f* 226
línea de banda *f* 220, 221, 226, 230
línea de falta *f* 229
línea de flotación *f* 214
línea de fondo *f* 221, 225, 226, 230
línea de gol *f* 220
línea de juego *f* 233
línea de meta *f* 223, 224, 234
línea de salida *f* 234
línea de servicio *f* 230
línea de tiro libre *f* 226
línea de tres *f* 226
línea del bateador *f* 225
línea divisoria *f* 194
líneas *f* 165
linfático 19

lino *m* 184, 277
linterna *f* 267
líquido 77
líquido amniótico *m* 52
líquido limpiador *m* 51
líquido limpiaparabrisas *m* 199
lista de lecturas *f* 168
lista de precios *f* 154
lista de vinos *f* 152
listón *m* 235
literatura *f* 162, 169
litro *m* 311
Lituania 316
llamada a cobro revertido *f* 99
llanta *f* 206
llanura *f* 285
llave *f* 59, 80, 203, 207
llave de boca *f* 80
llave de la habitación *f* 100
llave de memoria *f* 176
llave de paso *f* 61
llave de tubo *f* 80
llave del desagüe *f* 61
llave inglesa *f* 80
llegadas *f* 213
leno 64, 321
llorar 25
lluvia *f* 287
lo siento 322
lobo *m* 290
loción *f* 109
loción contra los insectos *f* 267
loción para después del sol *f* 108
locomotora *f* 208
logotipo *m* 31
lomo *m* 121
loncha *f* 119
longitud *f* 165, 283, 310
longitud de onda *f* 179
loro *m* 293
lubina *f* 120
luces *f* 94
luces de emergencia *f* 201
lucha libre *f* 236
lugares de interés *m* 261
luge *m* 247
luna *f* 280
luna de miel *f* 26
luna llena *f* 280
luna nueva *f* 280
lunar *m* 14
lunes 306
lupino *m* 297
Luxemburgo 316
luz de lectura *f* 210
luz del porche *f* 58
luz trasera *f* 204

M
macadamia *f* 129
Macedonia 316
maceta *f* 89, 110

- machacado 132
 macis *f* 132
 macramé *m* 277
 Madagascar 317
 madeja *f* 277
 mader *f* 179, 187, 275
 madera de pino *f* 79
 madera noble *f* 79
 madrastra *f* 23
 madre *f* 22
 madreSelva *f* 297
 maduro 129
 magdalena *f* 140
 magma *m* 283
 magnesio *m* 109
 magnetofón *m* 269
 maíz *m* 124, 130, 184
 maíz dulce *m* 122
 mal pase de balón *m* 220
 malaquita *f* 288
 malas hierbas *f* 86
 Malasia 318
 Malawi 317
 Maldivas 318
 maletero *m* 198
 maletín *m* 37
 Malí 317
 mallas *f* 31
 malo 321
 Malta 316
 Malvinas 315
 mamíferos *m* 290
 manada *f* 183
 manchego *m* 142
 "mándame un texto!" 99
 mandarina *f* 126
 mandarina clementina *f* 126
 mandarina satsuma *f* 126
 mandíbula *f* 14, 17
 mandioca *f* 124
 mando a distancia *m* 269
 mandos de la calefacción *m* 201
 manga *f* 34
 manga pastelera *f* 69
 mango *m* 128, 187, 230
 mangostán *m* 128
 manguera *f* 89, 95
 manguito *m* 238
 manicura *f* 41
 manillar *m* 207
 maniquí *m* 276
 mano *f* 13, 15
 mano de mortero *f* 68, 167
 manopla de cocina *f* 69
 manoplas *f* 30
 manta *f* 71, 74
 manta eléctrica *f* 71
 mantel *m* 64
 mantel individual *m* 64
 mantequilla *f* 137, 156
 mantequilla de cacahuètes *f* 135
 mantis religiosa *f* 295
 manto *m* 282
 manual 200
 manualidades *f* 274, 275, 276
 manzana *f* 126
 manzanilla *f* 149
 mañana *f* 305
 mañana 306
 mapache *m* 290
 mapamundi *m* 312
 maqueta *f* 190
 maquillaje *m* 40
 maquillaje de fondo *m* 40
 máquina de coser *f* 276
 máquina de cross *f* 250
 máquina de ejercicios *f* 250
 máquina de los cubitos *f* 67
 máquina de rayos *x f* 212
 máquina de remos *f* 250
 máquina de step *f* 250
 máquina del café *f* 148, 150
 máquina del fax *f* 172
 máquina fotográfica *f* 260
 maquinaria *f* 187
 maquinilla de afeitar eléctrica *f* 73
 mar *m* 264, 282
 Mar Báltico *m* 313
 Mar Caribe *m* 312
 Mar Caspio *m* 313
 Mar de Omán *m* 313
 Mar del Norte *m* 312
 Mar Mediterráneo *m* 313
 Mar Negro *m* 313
 Mar Rojo *m* 313
 maracas *f* 257
 maracuyá *m* 128
 maratón *f* 234
 marca personal *f* 234
 marcador *m* 225
 marcar 38, 99, 227
 marcar un gol 223
 marchas *f* 206
 marco *m* 62
 margarina *f* 137
 margarita *f* 110, 297
 marido *m* 22
 marino *m* 189
 mariposa *f* 239, 295
 mariquita *f* 295
 marisco *m* 121
 mármol *m* 288
 marquesina *f* 197
 marrón 274
 Marruecos 317
 Marte 280
 martes 306
 martillo *m* 80
 martillo neumático *m* 187
 martini *m* 151
 marzo 306
 más 165
 más allá de 320
 más tarde
 masa *f* 138, 140
 masa brisa *f* 140
 masa de profiteroles *f* 140
 masaje *m* 54
 máscara *f* 228, 249
 mascarilla *f* 41, 189
 masculino 21
 masilla *f* 83
 máster *m* 169
 mástil *m* 240, 258
 matasellos *m* 98
 mate 83, 271
 mate *m* 231
 matemáticas *f* 162, 164
 materiales *m* 79, 165, 187
 materiales de oficina *m* 173
 maternidad *f* 49
 matraz *m* 166
 matrícula *f* 198
 matriz *f* 52, 96
 Mauricio 317
 Mauritania 317
 mayo 306
 mayonesa *f* 135
 mazapán *m* 141
 mazo *m* 187, 275
 mazo de cocina *m* 68
 mazo para puré de patatas *m* 68
 mecánica *f* 202
 mecánico *m* 188, 203
 mechero *m* 112
 mechero Bunsen *m* 166
 medallas *f* 235
 media luna *f* 280
 media pensión *f* 101
 mediana *f* 194
 medianoche *f*
 media *f* 35
 medias de ligero *f* 35
 medicación *f* 109
 medicamento *m* 109
 medicina *f* 169
 médico *m* 45, 189
 medida *f* 151
 medida de capacidad *f* 311
 medidas *f* 165
 medidor *m* 150
 medidor óptico *m* 150
 medio ambiente *m* 280
 medio galope *m* 243
 medio litro *m* 311
 mediodía *m* 305
 medios de comunicación *m* 178
 medir 310
 meditación *f* 54
 médula *f* 126
 medusa *f* 295
 mejilla *f* 14
 mejillón *m* 121, 295
 mejorana *f* 133
 melée *f* 221
 melena *f* 39, 291
 melocotón *m* 126, 128
 melodía *f* 259
 melón *m* 127
 membrete *m* 173
 membrillo *m* 128
 memoria *f* 176
 menaje de hogar *m* 105
 menos 165
 mensaje de texto *m* 99
 mensaje de voz *m* 99
 mensajero *m* 99
 mensajes *m* 100
 menstruación *f* 20
 mensualmente 307
 menta *f* 133
 menta poleo *f* 149
 menú *m* 154
 menú de la cena *m* 152
 menú de la comida *m* 152
 menú para niños *m* 153
 menudillos *m* 118
 meñique *m* 15
 mercado *m* 115
 mercería *f* 105
 mercurio *m* 289
 Mercurio *m* 280
 merengue *m* 140
 mermelada *f* 134, 156
 mermelada de frambuesa *f* 134
 mermelada de naranja *f* 134, 156
 mes *m* 306
 mesa *f* 64, 148
 mesa de café *f* 62
 mesa de encolar *f* 82
 mesa de mezclas *f* 179
 mesa de picnic *f* 266
 mesa del desayuno *f* 156
 meseta *f* 284
 mesilla de noche *m* 70
 mesoesfera *f* 286
 metacarpo *m* 17
 metal *m* 79
 metales *m* 289
 metamórfico 288
 metatarso *m* 17
 meteorito *m* 280
 metralleta *f* 189
 metro *m* 209, 310
 metro cuadrado *m* 310
 México 314
 mezclar 67, 138
 mezquita *f* 300
 mica *f* 289
 microbús *m* 197
 micrófono *m* 179, 258
 microscopio *m* 167
 miel compacta *f* 134
 miel líquida *f* 134
 miércoles 306
 mijito *m* 130
 mil 309
 mil millones 309
 mil novecientos 307
 mil novecientos diez 307
 mil novecientos uno 307
 milenio *m* 307
 miligramo *m* 310
 mililitro *m* 311
 milímetro *m* 310
 milla *f* 310
 millón *m* 309
 minerales *m* 289
 mini bar *m* 101
 minuterio *m* 304
 minuto *m* 304
 miopía *f* 51
 mirilla *f* 59
 misil *m* 211
 mobiliario para el hogar *m* 105
 mocasín *m* 37
 mochila *f* 31, 37, 267
 mochila del bebé *f* 75
 moda *f* 277
 modalidades *f* 243
 modelismo *m* 275
 modelo *f* 169
 modelos *m* 199
 modista *f* 191
 modo de empleo *m* 109
 módulo lunar *m* 281
 moisés *m* 74
 Moldavia 316
 molde individual *m* 69
 molde para bizcocho *m* 69
 molde para magdalenas *m* 69
 molde para soufflé *m* 69
 molde redondo *m* 69
 moldura *f* 63
 molido 132
 Mónaco 316
 mondador *m* 68
 moneda *f* 97
 monedas devueltas *f* 99
 monedero *m* 37
 Mongolia 318
 monitor *m* 53
 monitor eléctrico de la presión sanguínea *m* 45
 mono *m* 82, 291
 monopatín *m* 249
 monopoly *m* 272
 monorrail *m* 208
 monovolumen *m* 199
 montaña *f* 284
 montaña rusa *f* 262
 Montañas Rocosas *f* 312
 montar en monopatín 249
 montar en patinete 263
 montar una tienda 266
 Monenegro 316
 montón de abono compuesto *m* 85
 montura *f* 51

- monumento *m* 261
monzón *m* 287
moño *m* 39
moño francés *m* 39
moqueta *f* 71
mora *f* 127
morado 274
morcilla *f* 157
mordisco *m* 46
moreno 41
morir 26
morro *m* 210
morsa *f* 290
mortero *m* 68, 167
mosca *f* 244, 295
mosquitera *f* 267
mosquito *m* 295
mostaza *f* 155
mostaza en grano *f* 131, 135
mostaza francesa *f* 135
mostaza inglesa *f* 135
mostrador *m* 96, 98, 100, 142
mostrador de bocadillos *m* 143
mostrador de facturación *m* 213
mostrador de préstamos *m* 168
moto acuática *f* 241
moto de carreras *f* 205
moto de carretera *f* 205
moto de cross *f* 205
moto de nieve *f* 247
motocicleta *f* 204
motociclismo *m* 249
motocross *m* 249
motor *m* 88, 202, 204, 210
motor fueraborda *m* 215
mousse *f* 141
móvil *m* 74
movimientos *m* 237
Mozambique 317
mozo de cuadra *m* 243
mozzarella *f* 142
mueble *m* 268
muela *f* 50
muelle *m* 71, 214, 216
muelle comercial *m* 216
muelle de pasajeros 216
muerte súbita *f* 230
muestra *f* 261
muffin *m* 140
mujer *f* 12, 22, 23
mujer de negocios *f* 175
muletilla *f* 31
multiplicado por 165
multiplicar 165
muñeca *f* 13, 15, 75
muñeco de peluche *m* 75
muñequera *f* 230
murciélagos *m* 290
músculos *m* 16
museo *m* 261
muserola *f* 242
música *f* 162
- música clásica *f* 255, 259
música country *f* 259
música de baile *f* 259
música folk *f* 259
musical *m* 255
músico *m* 191
muslo *m* 12, 119
Myanmar 318
- N, Ñ**
- naan *m* 139
nabo *m* 124
nabo sueco *m* 125
nacer 26
nacimiento *m* 52
nación *f* 315
nada *f* 230
nadador *m* 238
nadar 238
nailon *m* 277
nalga *f* 13
Namibia 317
naranja 274
naranja *f* 126
naranjada *f* 144
narciso *m* 111
narcisos silvestres *m* 297
nariz *f* 14
nasa *f* 245
nata *f* 137, 140, 157
nata agria *f* 137
nata líquida *f* 137
nata montada *f* 137
nata para montar *f* 137
natación *f* 238
natación sincronizada *f* 239
natillas *f* 140
natural 256
naturopatía *f* 55
náusea *f* 44
navaja *f* 121
navegación por satélite *f* 195, 201
navegador *m* 177
navegar 177, 240
Navidad *f* 27
neblina *f* 287
nebulosa *f* 280
nectarina *f* 126
negativo *m* 271
negocio *m* 175
negocios *m* 175
negro 39, 272, 274
neoclásico 301
Nepal 318
Neptuno *m* 280
nervio *m* 19, 50
nervio óptico *m* 51
nervioso 19, 25
neumático *m* 198, 205
neurología *f* 49
neutro 60
Nicaragua 314
niebla *f* 287
nieta *f* 22
- nieto *m* 22
nietos *m* 23
nieve *f* 287
Niger 317
Nigeria 317
niño *m* 23, 31
niño pequeño *m* 30
niños *m* 23
níquel *m* 289
nivel *m* 80, 187
no 322
no adosado 58
no doblar 98
no torcer a la derecha 195
noche *f* 305
nómina *f* 175
nonagésimo 309
noray *m* 214
normal 39
norte *m* 312
Noruega 316
nota *f* 163, 256
nota con saludos *f* 173
notación *f* 256
notas *f* 191
noticias *f* 178
novecientos 308
novenio 309
noventa 308
novia *f* 24
noviembre 306
novio *m* 24
nube *f* 113, 287
nublado 286
nuca *f* 13
núcleo externo *m* 282
núcleo interno *m* 282
nudillo *m* 15
nuera *f* 22
Nueva Zelanda 319
nuevo 308
nuevo 321
nuez *f* 19, 129
nuez del Brasil *f* 129
nuez moscada *f* 132
numerador *m* 165
número *m* 226
número de andén *m* 208
número de cuenta *m* 96
número de la habitación *m* 100
número de puerta de embarque *m* 213
número de ruta *m* 196
número de vuelo *m* 213
números *m* 308
nutria *f* 290
ñame *m* 125
- O**
- obertura *f* 256
objetivo *m* 270
oboe *m* 257
obra *f* 186, 254
obras *f* 187, 195
obsidiana *f* 288
oca *f* 119, 293
- océano *m* 282
Océano Antártico *m* 313
Océano Ártico *m* 312
Océano Atlántico *m* 312
Océano Índico *m* 312
Océano Pacífico *m* 312
ochenta 308
ocho 308
ochocientos 308
ocio *m* 254, 258, 264
ocio en el hogar *m* 268
octágono *m* 164
octavo 309
octogésimo 309
octubre 306
ocular *m* 167
ocupado 321
oeste *m* 312
ofertas *f* 106
oficina *f* 24, 172, 174
oficina central *f* 175
oficina de cambio *f* 97
oficina de correos *f* 98
oficina de información *f* 261
oficina del director del camping *f* 266
oftalmología *f* 49
ojal *m* 32, 37
ojo *m* 14, 51, 244, 276
ojo de buey *m* 214
ojos rojos *m* 271
ola *f* 241, 264
olmo *m* 296
Omán 318
ombigo *m* 12
omoplato *m* 17
once 308
oncología *f* 49
onda corta *f* 179
onda larga *f* 179
onda media *f* 179
ónice *m* 289
onza *f* 310
opera *m* 255
operación *f* 48
operador *m* 99
óptico *m* 51, 189
oradora *f* 174
órbita *f* 280
orden del día *m* 174
orden judicial *f* 180, 180
ordenador *m* 172, 176
ordenador portátil *m* 172, 175, 176
ordeñar 183
orégano *m* 133
oreja *f* 14
orfebrería *f* 275
organizador de las herramientas *m* 78
órganos reproductores *m* 20
orgullosos 25
orificio nasal *m* 290
orilla *f* 284
orinal *m* 74
- ornamental 87
ornitología *f* 263
oro *m* 235, 289
orquesta *f* 254, 256
orquídea *f* 111
ortiga *f* 297
ortopedia *f* 49
oruga *f* 295
orza *v* 241
oscuro 321
oso *m* 291
oso de peluche *m* 75
oso panda *m* 291
oso polar *m* 291
osteopatía *f* 54
ostra *f* 121
otoño *m* 31, 307
otorrinolaringología *f* 49
otras embarcaciones *f* 215
otras manualidades 275
otras tiendas *f* 114
otros deportes *m* 248
óvalo *m* 164
ovario *m* 20
oveja *f* 185
ovulación *f* 20, 52
óvulo *m* 20
- P**
- pacana *f* 129
paciente *f* 45
paciente externo *m* 48
paddle *m* 231
padrastró *m* 23
padre *m* 22
padres *m* 23
pagar 153
pago *m* 96
país *m* 315
paisaje *m* 284
Países Bajos 316
pajarería *f* 115
pajarita *f* 36
pájaro carpintero *m* 292
pajita *f* 144, 154
Pakistán 318
pala *f* 88, 187, 231, 265
pala para pescado *f* 68
paladar *m* 19
palanca *f* 61, 150
palanca de cambio *f* 201, 207
palanca de emergencia *f* 209
palanca de frenos *f* 207
palanca de la llanta *f* 207
palco *m* 254
paleta *f* 186, 187, 274
palma de la mano *f* 15
palmera *f* 86, 296
palmitos *m* 122
palo *m* 224, 225, 249, 273
palo de hierro *m* 233
palo de hockey *m* 224
palo de la tienda *m* 266
palo de madera *m* 233

- paloma *f* 292
 palomitas *f* 255
 palos de golf *m* 233
 pan *m* 138, 157
 pan al bicarbonato
 sódico *m* 139
 pan blanco *m* 139
 pan con grano *m* 139
 pan con semillas *m* 139
 pan de centeno *m* 138
 pan de maíz *m* 139
 pan de molde *m* 138
 pan de pita *m* 139
 pan dulce francés *m* 157
 pan fermentado *m* 139
 pan integral *m* 139, 149
 pan moreno *m* 139
 pan rallado *m* 139
 pan sin levadura *m* 139
 panadería *f* 107, 114, 138
 panadero *m* 139
 panal *m* 135
 Panamá 314
 páncreas *m* 18
 pandereta *f* 257
 panecillo *m* 139, 143
 pantalla *f* 97, 172, 176,
 255, 269
 pantalla de información *f*
 213
 pantalón de montar *m*
 242
 pantalones *m* 32, 34
 pantalones con peto *m*
 30
 pantalones cortos *m* 30,
 33
 pantalones vaqueros *m*
 31
 pantano *m* 285
 pantorrilla *f* 13, 16
 pañal *m* 75
 pañal de felpa *m* 30
 pañal desechable *m* 30
 pañuelo *m* 36
 pañuelo de papel *m* 108
 papaya *f* 128
 papel celo *m* 173
 papel de apresto *m* 83
 papel de lija *m* 81, 83
 papel estampado en
 relieve *m* 83
 papel maché *m* 275
 papel pintado *m* 82
 papelera *f* 172, 177
 papelería *f* 105
 paperas *f* 44
 papiroflexia *f* 275
 Papua Nueva Guinea
 319
 paquete *m* 99, 311,
 311
 paquete de tabaco *m*
 112
 par *m* 233
 para 320
 para comer en el local
 154
 para llevar 154
 parabrisas *m* 198, 205
 paracaídas *m* 248
 paracaidismo 248
 paracaidismo en caída
 libre *m* 248
 parachoques *m* 198
 parada *f* 237
 parada de autobús *f*
 197, 299
 parada de taxis *f* 213
 paraguas *m* 36, 233
 Paraguay 315
 paraguero *m* 59
 paralelas *f* 235
 paralelas asimétricas *f*
 235
 paralelo 165
 paralelogramo *m* 164
 parapente *m* 248
 parche *m* 207
 pared *f* 58, 186
 pareja *f* 24
 pareja prometida *f* 24
 parientes *m* 23
 parmesano *m* 142
 párpado *m* 51
 parque *m* 75, 262
 parque de atracciones *m*
 262
 parque de bomberos *m*
 95
 parque nacional *m* 261
 parquímetro *m* 195
 parrilla *f* 69, 69
 parto *m* 85, 90
 partida *f* 273
 partida de nacimiento *f*
 26
 parto *m* 230
 partitura *f* 255, 256
 parto *m* 52, 53
 parto asistido *m* 53
 parto de nalgas *m* 52
 pasa *f* 129
 pasa de Corinto *f* 129
 pasa sultana *f* 129
 pasado mañana 307
 pasajero *m* 216
 pasamanos *m* 59
 pasaporte *m* 213
 pasar 220
 pasar la bayeta 77
 pasarela *f* 212, 214
 Pascua judía *f* 27
 pase *m* 226
 paseo *m* 75, 243
 paseo marítimo *m* 265
 pasillo *m* 106, 168, 210,
 254
 paso *m* 243
 paso de peatones *m*
 195
 paso elevado *m* 194
 paso subterráneo *m* 194
 pasta *f* 158
 pasta de dientes *f* 72
 pastel *m* 149, 158
 pastel de nata *m* 141
 pasteles *m* 140, 274
 pasteles de carne *m* 143
 pasteurizado 137
 pastilla *f* 258, 311
 pastilla de menta *f* 113
 pastilla para hogueras *f*
 266
 pastilla para la garganta *f*
 109
 pasto *m* 182
 pata *f* 64
 patada *f* 124, 237, 239
 patata nueva *f* 124
 patatas fritas *f* 113, 151,
 154
 paté *m* 142, 156
 patilla de apoyo *f* 207
 patín *m* 247
 patín de cuchilla *m* 224
 patinaje *m* 263
 patinaje artístico *m* 247
 patinaje de velocidad *m*
 247
 patinaje en línea *m* 249
 patinaje sobre hielo *m*
 247
 patinar 224
 patio *m* 58, 84
 patio de butacas *m* 254
 patito *m* 185
 pato *m* 119, 185
 patología *f* 49
 patrimonio neto *m* 97
 patrón *m* 276
 patucos *m* 30
 pausa *f* 256, 269
 pavo *m* 119, 185, 293
 pavo real *m* 293
 peca *f* 15
 peces *m* 294
 pecho *m* 12
 pechuga *f* 119
 pectoral *m* 16
 pedal *m* 61, 206, 257
 pedal de los frenos *m* 205
 pedalear 207
 pedernal *m* 288
 pediatría *f* 49
 pedicura *f* 41
 pedir 153
 peinar 38
 peine *m* 38
 pelacables *m* 81
 pelado 129
 pelar 67
 pelele *m* 30
 pelele sin pies *m* 30
 pelicano *m* 292
 película *f* 260, 271
 película de aventuras *f*
 255
 película de ciencia
 ficción *f* 255
 película de dibujos
 animados *f* 255
 película de terror *f* 255
 película de suspense *f*
 255
 película del oeste *f* 255
 película romántica *f* 255
 peligro *m* 195
 pelirrojo 39
 pelo *m* 14, 38
 pelo corto *m* 39
 pelota *f* 75, 224, 228,
 230
 pelota de críquet *f* 225
 pelota de golf *f* 233
 pelota de playa *f* 265
 peloteo *m* 230
 peluca *f* 39
 peluquera *f* 38
 peluquería *f* 115
 peluquero *m* 188
 pelvis *f* 17
 penalti *m* 222
 pendiente *m* 36
 pene *m* 21
 península *f* 282
 pensión completa *f* 101
 pentágono *m* 164
 pentagrama *f* 256
 peón *m* 272
 peonía *f* 111
 pepino *m* 125
 pepita *f* 127, 128
 pequeño 321
 pera *f* 127
 percha *f* 70
 percusión *f* 257
 perdedor *m* 273
 perder 273
 perdone 322
 perejil *m* 133
 perenne 86
 perforadora *f* 173
 perfumado 130
 perfume *m* 41
 perfumería *f* 105
 pérgola *f* 84
 periferia *f* 299
 periódico *m* 112, 168
 periodista *m* 190
 permanente *f* 39
 peroné *m* 17
 perpendicular 165
 perrito caliente *m* 155
 perro *m* 290
 perseguir 229
 personal *m* 175
 pértiga *f* 245
 Perú 315
 pesa *f* 166, 251
 pesado 321
 pesar 310
 pesas *f* 250
 pesca *f* 244
 pesca con arpón *f* 245
 pesca con mosca *f* 245
 pesca de altura *f* 245
 pesca deportiva *f* 245
 pesca en agua dulce *f*
 245
 pesca en alta mar
 f 245
 pesca en la orilla *f* 245
 pescadera *f* 188
 pescadería *f* 114, 120
 pescadilla *f* 120
 pescado *m* 107, 120
 pescado ahumado *m*
 143
 pescado y las patatas
 fritas *m* 155
 pescador *m* 189
 pescador de caña *m*
 244
 peso *m* 118
 peso al nacer *m* 53
 pestaña *f* 14, 51
 pesticida *m* 89, 183
 pestillo *m* 200
 pétalo *m* 297
 penaltista *m* 215
 pez de colores *m* 294
 pez espada *m* 120, 294
 pezón *m* 12
 pezuña *f* 291
 phisicallis *m* 128
 piano *m* 256
 pica *f* 273
 picadura *f* 46
 picante 124
 picar 245
 picnic *m* 263
 pico *m* 187, 293
 pie *m* 12, 15, 310
 pie cuadrado *m* 310
 pie de la aguja *m* 276
 pie del altavoz *m* 268
 piedra *f* 36, 275
 piedra afiladora *f* 81
 piedra arenisca *f* 288
 piedra caliza *f* 288
 piedra lunar *f* 288
 piedra pómez *f* 73, 288
 piel *f* 14, 119, 128
 pierna *f* 12, 119
 pijama *m* 33
 pijama enterizo *m* 30
 pila *f* 167
 pilas *f* 260
 pilates *m* 251
 píldora *f* 21, 109
 píldoras para el mareo *f*
 109
 piloto *m* 190, 211
 piloto de carreras *m* 249
 pimentón *m* 132
 pimienta *f* 64, 152
 pimienta de Jamaica *f*
 132
 pimienta en grano *f* 132
 pimientó *m* 124
 pin *m* 96
 pincel *m* 274
 pincel de labios *m* 40
 pinchadiscos *m* 179
 pinchazo *m* 203, 207
 pincho *m* 68, 158
 pincho moruno *m* 155
 ping-pong *m* 231
 pingüino *m* 292

- pino *m* 296
 pinta *f* 311
 pintar 83
 pintor *m* 82
 pintora *f* 191, 274
 pintura *f* 83, 274
 pintura acrílica *f* 274
 pintura al agua *f* 83
 pinturas *f* 274
 pinturas al óleo *f* 274
 pinza *f* 167
 pinza para la nariz *f* 238
 pinza para la ropa *f* 76
 pinzas *f* 40, 47, 150, 167
 piña *f* 128
 piñón *m* 129, 207
 pipa *f* 112
 pipa de calabaza *f* 131
 pipa de girasol *f* 131
 pipeta *f* 167
 piragüismo *m* 241
 pirámide *f* 164
 piruleta *f* 113
 piscifactoría *f* 183
 piscina *f* 101, 238, 250
 piscina de plástico *f* 263
 piso *m* 58, 59
 pista *f* 212, 234, 246
 pista de esquí *f* 246
 pista de estacionamiento *f* 212
 pista de hockey sobre hielo *f* 224
 pista de tenis *f* 230
 pistacho *m* 129
 pistola *f* 94
 pistola para encolar *f* 78
 pitcher *m* 229
 pizarra *f* 162, 174, 288
 pizza *f* 154
 placa *f* 67, 94, 283
 placa bacteriana *f* 50
 placa de identificación *f* 189
 placa de la aguja *f* 276
 placa vitrocerámica *f* 66
 placar 220
 placenta *f* 52
 plancha *f* 76
 plancha de pelo *f* 38
 planchar 76
 planeador *m* 211, 248
 planeta *m* 280, 282
 plano *m* 261
 plano de la planta *m* 261
 plano del metro *m* 209
 planta *f* 48
 planta acuática *f* 86
 planta alpestre *f* 87
 planta baja *f* 104
 planta de flor *f* 297
 planta de maceta *f* 87
 planta de sombra *f* 87
 planta del pie *f* 15
 planta para cubrir suelo *f* 87
 planta suculenta *f* 87
 planta trepadora *f* 87
- plantar 183
 plantar en tiesto 91
 plantas *f* 296
 plantas de jardín *f* 86
 plantas podadas con formas *f* 87
 plantilla *f* 83
 plantón *m* 91
 plata *f* 235, 289
 plataforma de lanzamiento *f* 228
 plátano *m* 128
 platea *f* 254
 platea alta *f* 254
 platija *f* 120
 platillos *m* 257
 platina portaobjeto *f* 167
 platino *m* 289
 platito *m* 65
 plató *m* 178
 plató de rodaje *m* 179
 plato *m* 65
 plato llano *m* 65
 plato principal *m* 153
 plato sopero *m* 65
 platos *m* 153
 platos del día *m* 152
 platos preparados *m* 107
 play *m* 269
 playa *f* 264
 plaza *f* 266, 299
 pletina *f* 268
 plomo *m* 244
 pluma *f* 293
 plumcake *m* 139
 plum-cake *m* 140
 Plutón *m* 280
 pocilga *f* 185
 podadera de mango largo *f* 88
 podar 90, 91
 podio *m* 235, 256
 podrido 127
 póker *m* 273
 policía *m* 189
 policía *f* 94
 policía de tráfico *m* 195
 poliéster *m* 277
 polilla *f* 295
 política *f* 169
 pollo *m* 119
 pollo frito *m* 155
 pollo preparado *m* 119
 polluelo *m* 185
 polo *m* 243, 282
 Polo Norte *m* 283
 Polonia 316
 polvera *f* 40
 polvos *m* 109
 polvos compactos *m* 40
 polvos de talco *m* 73
 pomada *f* 47, 109
 pomelo *m* 126
 pomo de la puerta *m* 59
 poner césped 90
 poner el despertador 71
 poner en remojo 130
 poner la mesa 64
- pop *m* 259
 popa *f* 240
 popurrí *m* 111
 por 320
 por avión 98
 por favor 322
 porcentaje *m* 165
 porche *m* 58
 porciones de pollo *f* 155
 poro *m* 15
 porra *f* 94
 portaaviones *m* 215
 portabolígrafo *m* 172
 portaequipaje *m* 204
 portaequipajes *m* 196, 209
 portalámparas de bayoneta *m* 60
 portaobjetos *m* 167
 portarretratos *m* 271
 portería *f* 221, 223, 224
 portero *m* 222, 224
 Portugal 316
 posavasos *m* 150
 posgrado 169
 poste *m* 222, 247
 poste de la portería *m* 220
 póster *m* 255
 postre *m* 153
 postre de soletillas, gelatina de frutas y nata *m* 141
 postura *f* 232
 potro *m* 185
 pradera *f* 285
 prado *m* 285
 precio *m* 152, 199, 209
 precio de entrada *m* 260
 pregunta 163
 preguntar 163
 prematuro 52
 premolar *m* 50
 prensa *f* 178
 prensaajios *m* 68
 preocupado 25
 prepucio *m* 21
 presentación *f* 174
 presentador *m* 178, 191
 presentadora de las noticias *f* 179
 presidir 174
 presión del neumático *f* 203
 préstamo *m* 96, 168
 primavera *f* 307
 primer piso *m* 141
 primera mano *f* 83
 primera planta *f* 104
 primero 309
 primeros auxilios *m* 47
 primo *m* 22
 primula *f* 297
 principado *m* 315
 principio *m* 321
 prismáticos *m* 281
 proa *f* 215, 240
 probadores *m* 104
- problemas *m* 271
 procesador *m* 176
 productor *m* 254
 productos de belleza *m* 105
 productos de limpieza *m* 107
 productos lácteos *m* 136
 profesiones *f* 188, 190
 profesor *m* 169, 191
 profesora *f* 162
 profiterol *m* 140
 profundidad *f* 165
 programa *m* 176, 254, 269
 programación *f* 178
 prohibido el paso *m* 195
 prohibido parar 195
 prometida *f* 24
 prometido *m* 24
 propagar 91
 propietario *m* 58
 propuesta *f* 174
 propulsor *m* 281
 prórroga *f* 223
 próstata *f* 221
 protector *m* 83, 88, 236
 protector de la cara *m* 225
 protector de la pierna *m* 225
 protegedores *m* 237
 proveedor de servicios *m* 177
 provincia *f* 315
 provocar el parto 53
 proyector digital *m* 163
 prueba *f* 181
 prueba del embarazo *f* 52
 pruebas *f* 247
 psicoterapia *f* 55
 psiquiatría *f* 49
 público *m* 254
 pueblo *m* 299
 puente *m* 15, 214, 258, 300
 puenting *m* 248
 puerro *m* 125
 puerta *f* 85, 182, 196, 198, 209
 puerta automática *f* 196
 puerta de la ducha *f* 72
 puerta del maletero *f* 198
 puerta exterior *f* 59
 puerta principal *f* 58
 puerto *m* 176, 214, 216, 217
 puerto de pesca *m* 217
 puerto deportivo *m* 217
 Puerto Rico 314
 puesta de sol *f* 305
 puesto callejero *m* 154
 pulgada *f* 310
 pulgar *m* 15
 pulmón *m* 18
 pulpa *f* 124, 127, 129
 pulpejo *m* 15
 pulpo *m* 121, 295
- pulsera *f* 36
 pulsera de identificación *f* 53
 pulso *m* 47
 pulverizador *m* 89, 311
 punta *f* 36, 122, 163, 246
 puntada *f* 277
 puntas abiertas *f* 39
 punto *m* 273
 punto de amarre *m* 217
 puntos *m* 52
 puntuación *f* 220, 273
 puntual 305
 puñetazo *m* 237
 puño *m* 15, 32, 237
 pupila *f* 51
 pupitre *m* 162
 puro *m* 112
 putter *m* 233
 puzzle *m* 273
- Q**
 Qatar 318
 quebrado *m* 165
 quemador *m* 61, 67
 quemadura *f* 46
 quemadura de sol *f* 46
 queso *m* 136, 156
 queso azul *m* 136
 queso cremoso *m* 136
 queso cremoso semicurado *m* 136
 queso curado *m* 136
 queso de bola *m* 142
 queso de cabra *m* 142
 queso fresco *m* 136
 queso rallado *m* 136
 queso semicurado *m* 136
 quiche *f* 142
 quilla *f* 214
 química *f* 162
 quince 308
 quince días 307
 quincuagésimo 309
 quingombó *m* 122
 quinientos 308
 quinoa *f* 130
 quinto 309
 quirófano *m* 48
 quiropráctica *f* 54
 quitaesmalte *m* 41
 quitar las flores muertas 91
 quizá 322
- R**
 rábano *m* 124
 rábano picante *m* 125
 ración *f* 64
 radar 281
 radar *m* 214
 radiador *m* 60, 202
 radichio *m* 123
 radio *m* 17, 164, 207
 radio *f* 179, 268
 radio del coche *f* 201
 radio despertador *f* 70

- radio digital *f* 268
 radiografía *f* 48, 50
 radiología *f* 49
 rafting *m* 241
 rail *m* 208
 rail electrificado *m* 209
 raíz *f* 50, 124, 296
 raíz del taro *f* 124
 ralenti *m* 203
 rallador *m* 68
 rallar 67
 rally *m* 249
 RAM *m* 176
 rama *f* 296
 ramadán *m* 26
 ramas *f* 133
 ramillete aromático *m* 132
 ramita *f* 296
 ramo *m* 111
 ramo de flores *m* 35
 rampa de lanzamiento *f* 281
 rampa para sillas de ruedas *f* 197
 rana *f* 294
 ranúnculo *m* 297
 ranura de la tarjeta *f* 97
 rap *m* 259
 rape *m* 120
 rápido 321
 rápidos *m* 240, 284
 rappel *m* 248
 raqueta *f* 230
 rascacielos *m* 299, 300
 raspador *m* 82
 raspar 77
 rastrillar 90
 rastrillo *m* 88, 225
 rastrillo para el césped *m* 88
 rata *f* 290
 ratón *m* 176, 290
 raya *f* 120, 294
 rayos ultravioleta *m* 286
 rayos x dentales *m* 50
 reanimación *f* 47
 rebanada *f* 139
 rebanador *m* 139
 rebaño *m* 183
 rebeca *f* 32
 recalentar 154
 recepción *f* 100
 recepcionista *f* 100, 190
 receta *f* 45
 recibir 177, 227
 recibo *m* 152
 recién nacido *m* 53
 recipiente *m* 311
 recogedor *m* 77
 recogepelotas *m* 231
 recoger 245
 recogida *f* 98
 recogida de equipajes *f* 213
 recolectar 183
 récord *m* 234
 rectángulo *m* 164
 recto *m* 21
 recto 165, 260
 recuerdos *m* 260
 red *f* 176, 217, 222, 226, 227, 231
 red! 231
 red ferroviaria *f* 209
 red para las capturas *f* 244
 red para recoger *f* 244
 redacción *f* 163
 redactora *f* 191
 redil *m* 185
 reducir 172
 refectorio *m* 168
 reflejos *m* 39
 reflexología *f* 54
 refresco *m* 154
 refrescos *m* 144
 regadera *f* 89
 regaliz *m* 113
 regalo *m* 27
 regar 90, 183
 regatear 223
 reggae *m* 259
 región *f* 315
 registro *m* 100
 regla *f* 163, 165
 regulador *m* 239
 reiki *m* 55
 reina *f* 272, 273
 Reino Unido 316
 reír 25
 rejilla *f* 69
 relaciones *f* 24
 relajación *f* 55
 relámpago *m* 287
 rellenar 82
 relleno 159
 relleno *m* 140, 155
 reloj *m* 36, 304
 reloj despertador *m* 70
 remar 241
 remedios de herbolario *m* 108
 remero *m* 241
 remite *m* 98
 remo *m* 241
 remolacha *f* 125
 remolcador *m* 215
 remolcar 195
 remolque *m* 266
 remolque del equipaje *m* 212
 remover 67
 Renacimiento 301
 renacuajo *m* 294
 renovar 168
 reparto *m* 98, 254
 repelente de insectos *m* 108
 reportera *f* 179
 reposabrazos *m* 200
 reposacabezas *m* 200
 repostería *f* 69, 140
 reproducción *f* 20
 reproductor 19
 reproductor de DVD *m* 268
 reptiles *m* 293
 República Centroafricana 317
 República Checa 316
 República Democrática del Congo 317
 República Dominicana 314
 requesón *m* 136
 reserva *m* 223
 reservar 168
 reservar un vuelo 212
 resfriado *m* 44
 resistencia *f* 61
 resistente al horno 69
 respaldo *m* 64, 210
 respiración *f* 47
 respiratorio 19
 respuesta *f* 163
 restar 165
 restaurante *m* 101, 152
 resto *m* 231
 restregar 77
 resultado *m* 49
 retina *f* 51
 retraso *m* 209
 retrato robot *m* 181
 retrete *m* 61
 retrovisor exterior *m* 198
 reunión *f* 174
 revelar 271
 revés *m* 231
 revestimiento *m* 187
 revisión *f* 50
 revisor *m* 209
 revista *f* 112, 168
 revistas *f* 107
 revuelto *m* 158
 rey *m* 272, 273
 riego *f* 89
 riendas *f* 242
 rímel *m* 40
 ring *m* 237
 rinoceronte *m* 291
 riñón *m* 18, 119
 río *m* 284
 ritmo *m* 259
 rizado 39
 roble *m* 296
 robo *m* 94
 robot de cocina *m* 66
 rocalla *f* 84
 rocas *f* 284, 288
 rociar 91
 roció 301
 rodaja *f* 121
 rodeo *m* 243
 rodilla *f* 12
 rodillera *f* 205, 227
 rodilleras *f* 220
 rodillo *m* 83
 rodillo de cocina *m* 69
 rojizo 39
 rojo 274
 rollo *m* 311
 rollo de papel higiénico *m* 72
 rombo *m* 164, 273
 romero *m* 133
 romper aguas 52
 rompiente *f* 241
 ron *m* 145
 ron con Coca-Cola *m* 151
 roncar 71
 ropa de caballero *f* 32, 105
 ropa de cama *f* 71, 74
 ropa de hogar *f* 105
 ropa de niño *f* 30
 ropa de señora *f* 34, 105
 ropa impermeable *f* 245, 267
 ropa interior *f* 32
 ropa interior térmica *f* 35
 ropa limpia *f* 76
 ropa para dormir *f* 31
 ropa sport *f* 33
 ropa sucia *f* 76
 ropa termoaislante *f* 267
 rócula *f* 123
 rosa 274
 rosa *f* 110
 rosado 145
 rosquilla *f* 139
 rótula *f* 17
 rótulo *m* 173
 rough *m* 232
 roulotte *f* 266
 rubí *m* 288
 rubio 39
 rueda *f* 198, 207
 rueda de ajuste *f* 276
 rueda de repuesto *f* 203
 rueda delantera *f* 196
 rueda del diafragma *f* 270
 rueda trasera *f* 197
 ruedas de apoyo *f* 207
 ruedo *m* 243
 rugby *m* 221
 ruibarbo *m* 127
 ruina famosa *f* 261
 rulo *m* 38
 Rumania 316
 Rwanda 317
S
 sábado 306
 sábana *f* 71, 74
 saca postal *f* 98
 sacacorchos *m* 150
 sacaleches *m* 53
 sacapuntas *m* 163
 sacar 231
 sacar brillo 77
 saco de arena *m* 237
 saco de dormir *m* 267
 safari park *m* 262
 Sáhara *m* 313
 Sáhara Occidental 317
 Saint Kitts y Nevis 314
 sal *f* 64, 152
 sala de embarque *f* 213
 sala de espera *f* 45
 sala de lecturas *f* 168
 sala de máquinas *f* 214
 sala de maternidad *f* 48
 sala de pediatría *f* 48
 sala de reuniones *f* 174
 sala de urgencias *f* 48
 sala del tribunal *f* 180
 salado 121, 129, 137, 143, 155
 salamandra *f* 294
 salami *m* 142
 salchicha *f* 155, 157
 salchichas *f* 118
 salchichón *m* 142
 salida *f* 61, 194, 210, 232
 salida de emergencia *f* 210
 salida de incendios *f* 95
 salidas *f* 213
 salir 233
 salmón *m* 120
 salmonete *m* 120
 salpicadero *m* 201
 salsa *f* 134, 143, 155
 saltador *m* 238
 saltamontes *m* 295
 saltar 227
 saltar a la comba 251
 saltear 67
 salto *m* 235, 237, 239, 243, 247
 salto alto *m* 239
 salto con pértiga *m* 234
 salto de altura *m* 235
 salto de longitud *m* 235
 salto de salida *m* 239
 salto entre dos *m* 226
 salto mortal *m* 235
 salud *f* 44
 salvado *m* 130
 salvaslip *m* 108
 salvavidas *m* 240
 salvia *f* 133
 San Marino 316
 San Vicente y las Granadinas 314
 sandalia *f* 37
 sandalias *f* 31
 sandía *f* 127
 sandwich abierto *m* 155
 sandwich tostado *m* 149
 Santa Lucía 314
 Santo Tomé y Príncipe 317
 sapo *m* 294
 saque de banda *m* 223, 226
 sarampión *m* 44
 sardina *f* 120
 sarpullido *m* 44
 sartén *f* 69
 sastré *m* 191
 sastré 35
 sastrería *f* 115
 satélite *m* 281
 Saturno *m* 280

- sauce *m* 296
 sauna *f* 250
 saxofón *m* 257
 scanner *m* 176
 scrabble *m* 272
 secador *m* 38
 secadora *f* 76
 secar 76
 secar con el secador 38
 sección *f* 282
 sección de equipajes *f* 104
 sección de zapatería *f* 104
 sección infantil *f* 104
 seco 39, 41, 130, 145, 286, 321
 secretaria *f* 168
 seda *f* 277
 sedal *m* 244
 sedimentario 288
 segunda planta *f* 104
 segundero *m* 304
 segundo *m* 304
 segundo 309
 seguridad *f* 212, 240
 seguridad *f* 75
 seguro *m* 203
 seguro de sí mismo 25
 seis 308
 seiscientos 308
 selector de puntada *m* 276
 sellante *m* 83
 sello *m* 98, 173
 sellos *m* 112
 selva tropical *f* 285
 semáforo *m* 194
 semana *f* 306
 semana pasada *f* 307
 semana que viene *f* 306
 Semana Santa *f* 27
 semanalmente 307
 sembrar 90, 183
 semilla *f* 122, 130
 semilla de sésamo *f* 131
 semilla de soja *f* 131
 semillas *f* 88, 131
 semillas de amapola *f* 138
 semillas de hinojo *f* 133
 semillero *m* 89
 sémola *f* 130
 senderismo *m* 263
 sendero *m* 262
 sendero para caballos *m* 263
 Senegal 317
 seno *m* 19
 sensible 41
 sentarse en cuclillas 251
 sentencia *f* 181
 señal *m* 209
 señal de tráfico *f* 298
 señales de tráfico *f* 195
 señales horizontales *f* 194
 Señor *m* 23
 Señora *f* 23
- Señorita *f* 23
 señuelo *m* 244
 sepia *f* 121
 septiembre 306
 séptimo 309
 septuagésimo 309
 Serbia 316
 serie *f* 179
 serie televisiva *f* 178
 serpiente *f* 293
 serrar 79
 serrucho *m* 80
 serrucho de costilla *m* 81
 servicio *m* 231
 servicio al cliente *m* 104
 servicio de habitaciones *m* 101
 servicio de lavandería *m* 101
 servicio de limpieza *m* 101
 servicio incluido 152
 servicio no incluido 152
 servicios *m* 49
 servicios de emergencia *m* 94
 servidor *m* 176
 servilleta *f* 65
 servilleta de papel *f* 154
 servilletero *m* 65
 servir 64
 sesenta 308
 set *m* 230
 setecientos 308
 setenta 308
 seto *m* 85, 90, 182
 sexagésimo 309
 sexto 309
 shiatsu *m* 54
 shock *m* 47
 sí 322
 Sicilia 313
 Sicilia 316
 sidra *f* 145
 sien *f* 14
 sierra circular *f* 78
 sierra de calar *f* 81
 sierra de mano *f* 89
 sierra de vaivén *f* 78
 Sierra Leona 317
 sierra para metales *f* 81
 siete 308
 siglo *m* 307
 silenciador *m* 203, 204
 silla *f* 64
 silla de montar *f* 242
 silla de montar de señora *f* 242
 silla de ruedas *f* 48
 silla giratoria *f* 172
 silla para el niño *f* 207
 silla para niños *f* 198
 silleta de paseo *f* 75
 sillín *m* 206, 242
 sillón *m* 63
 sillón del dentista *m* 50
 silo *m* 183
- sin 320
 sin escamas 121
 sin espinas 121
 sin gas 144
 sin grasa 137
 sin mangas 34
 sin pasteurizar 137
 sin pepitas 127
 sin piel 121
 sin plomo 199
 sin sal 137
 sin tirantes 34
 sinagoga *f* 300
 sinfonía *f* 256
 Singapur 319
 sintético 31
 sintonizar 179
 sintonizar la radio 269
 sintonizador digital *m* 269
 sirena *f* 94
 Siria 318
 sistema *m* 176
 sistema de megafonía *f* 209
 sistema solar *m* 280
 sistemas *m* 19
 sitio web *m* 177
 sláalom *m* 247
 sláalom gigante *m* 247
 snowboard *m* 247
 sobre 320
 sobre *m* 98, 173
 sobre par *m* 233
 sobreexposición 271
 sobrina *f* 23
 sobrino *m* 23
 socia *f* 24
 socorrista *m* 239, 265
 soda *f* 144
 sofá *m* 62
 sofá-cama *m* 63
 software *m* 176
 sol *m* 280
 solapa *m* 32
 soldado *m* 189
 soldador *m* 81
 soldar 79
 soleado 286
 soletillas *f* 141
 soltar 245
 soluble 109
 solución desinfectante *f* 51
 Somalia 317
 sombra de ojos *f* 40
 sombrero *m* 36
 sombrero para el sol *m* 265
 sombrilla *f* 264
 somnífero *m* 109
 sonajero *m* 74
 sonata *f* 256
 sonda *f* 50
 sonrisa *f* 25
 sopa *f* 153, 158
 soporte *m* 88, 166, 187, 205
- soporte de la agarradera *m* 166
 soporte del papel celo *m* 173
 soporte del sillín *m* 206
 sorbete *m* 141
 sorprendido 25
 sospechoso *m* 94, 181
 sostenido 256
 sótano *m* 58
 soufflé *m* 158
 sport 34
 spray *m* 109, 311
 squash *m* 231
 Sri Lanka 318
 stop *m* 269
 strike *m* 228
 suavizante *m* 38, 76
 subexpuesto 271
 subibaja *m* 263
 subir 139
 submarino *m* 215
 subsuelo *m* 91
 sucursal *f* 175
 sudadera *f* 33
 Sudáfrica 317
 Sudán 317
 Sudán del Sur 317
 Suecia 316
 suegra *f* 23
 suegro *m* 23
 suela *f* 37
 sueldo *m* 175
 suelo *m* 62, 71
 suelo aislante *m* 267
 suero de la leche *m* 137
 Suiza 316
 sujetador *m* 35
 sujetador para la lactancia *m* 53
 sujetapapeles *m* 173
 sumar 165
 sumidero *m* 299
 suministro de electricidad *m* 60
 sumo *m* 237
 supermercado *m* 105, 106
 suplemento *m* 55
 supositorio *m* 109
 sur *m* 312
 surco *m* 183
 surfing *m* 241
 surfista *m* 241
 Suriname 315
 surtidor *m* 199
 suspensión *f* 203, 205
 suspirar 25
 sustitución *f* 223
 Swazilandia 317
 swing de práctica *m* 233
- tabla para cortar *f* 68
 tablero *m* 226
 tablero de ajedrez *m* 272
 tablero de densidad media *m* 79
 tableta de chocolate *f* 113
 tablilla *f* 47
 tablilla con sujetapapeles *f* 173
 tablón de anuncios *m* 173
 taburete *m* 150
 taco *m* 155
 taco del freno *m* 207
 tacón *m* 37
 taekwondo *m* 236
 tai-chi *m* 236
 Tailandia 318
 taladrar 79
 taladro eléctrico *m* 78
 taladro inalámbrico *m* 78
 taladro manual *m* 78, 81
 talla en madera *f* 275
 taller 79
 taller *m* 78, 199, 203
 tallo *m* 111, 122, 297
 talón *m* 13, 15
 talonario de cheques *m* 96
 tambor pequeño *m* 257
 tampón *m* 108
 tándem *m* 206
 tanque *m* 61
 tanque de la gasolina *m* 203, 204
 tanque del agua *m* 61
 Tanzania 317
 tapa *f* 61, 66
 tapa del objetivo *f* 270
 tapa del wáter *f* 72
 tapacubo *m* 202
 tapadera *f* 69
 tapón *m* 72, 166
 taquígrafa *f* 181
 taquilla *f* 209, 255
 taquillas *f* 239
 tarde *f* 305
 tarde 305
 tarifa *f* 197
 tarjeta *f* 27
 tarjeta amarilla *f* 223
 tarjeta de crédito *f* 96
 tarjeta de débito *f* 96
 tarjeta de embarque *f* 213
 tarjeta de la biblioteca *f* 168
 tarjeta postal *f* 112
 tarjeta roja *f* 223
 tarrina *f* 311
 tarro *m* 134, 311
 tarro hermético *m* 135
 tarta nupcial *f* 141
 tarta de chocolate *f* 140
 tarta de cumpleaños *f* 141
 tarjeta de fruta *f* 140
 tartas para

- celebraciones *f* 141
 Tasmania 319
 tatuaje *m* 41
 taxista *m* 190
 Tayikistán 318
 taza *f* 61, 65, 75
 taza de café *f* 65
 taza de té *f* 65
 té *m* 144, 149, 184
 té con hielo *m* 149
 té con leche *m* 149
 té con limón *m* 149
 té en hoja *m* 144
 té solo *m* 149
 té verde *m* 149
 teatro *m* 254, 299
 tebeo *m* 112
 techo *m* 62, 203
 techo solar *m* 202
 tecla *f* 176
 teclado *m* 97, 99, 172, 176, 258
 técnicas *f* 79, 159
 técnico de sonido *m* 179
 tee *m* 233
 teja *f* 58, 187
 tejado *m* 58
 tejanos *m* 33
 tejer 277
 tela *f* 276, 277
 tela metálica *f* 167
 telar *m* 277
 teleférico *m* 246
 teléfono *m* 99
 teléfono con cámara *m* 270
 teléfono de emergencia *m* 195
 teléfono inalámbrico *m* 99
 teléfono inteligente *m* 176
 teléfono móvil *m* 99
 telegrama *m* 98
 telenovela *f* 178
 teleobjetivo *m* 270
 telepizzería *f* 154
 telescopio *m* 281
 telesilla *f* 246
 televisión *f* 268
 televisión por cable *f* 269
 telón *m* 254
 telón de fondo *m* 254
 televisor de pantalla plana *m* 269
 temblor *m* 283
 témpera *f* 274
 temperatura *f* 286
 templo *m* 300
 temprano 305
 tenazas *f* 81, 167
 tenazas de alambre *f* 80
 tendón *m* 17
 tendón de Aquiles *m* 16
 tendón de la corva *m* 16
 tenedor *m* 65, 153
 tenedor para trinchar *m* 68
 tener un hijo 26
 tenis *m* 230, 231
 tensión arterial *f* 44
 teñido 39
 tequila *m* 145
 terapeuta *m* 55
 terapeuta *f* 55
 terapia de grupo *f* 55
 terapias alternativas *f* 54
 tercero 309
 terminal *f* 212
 terminal del ferry *f* 216
 termita *f* 295
 termo *m* 267
 termoesfera *f* 286
 termómetro *m* 45, 167
 termostato *m* 61
 ternera *f* 118
 ternero *m* 185
 terraza *f* 85, 148
 terraza ajardinada *f* 85
 terremoto *m* 283
 territorio *m* 315
 tesina *f* 169
 tesis *f* 169
 testículo *m* 21
 testigo *m* 180, 235
 tetera *f* 65
 tetina *f* 75
 tetrabrik *m* 311
 tía *f* 22
 tibia *f* 17
 tiburón *m* 294
 tiempo *m* 234, 286, 304
 tiempo muerto *m* 220
 tienda *f* 298
 tienda de antigüedades *f* 114
 tienda de artículos de regalo *f* 114
 tienda de campaña *f* 267
 tienda de discos *f* 115
 tienda de fotografía *f* 115
 tienda de golosinas *f* 113
 tienda de licores *f* 115
 tienda de materiales de arte *f* 115
 tienda de muebles *f* 115
 tienda de artículos usados *f* 115
 tienda libre de impuestos 213
 tiendas *f* 114
 Tierra *f* 280, 282
 tierra *f* 85
 tierra firme *f* 282
 tierras de labranza *f* 182
 tigre *m* 291
 tijeras *f* 38, 47, 82, 276
 tijeras de podar *f* 89
 tijeras de uñas *f* 41
 tilo *m* 296
 timbal *m* 257
 timbre *m* 48, 59, 197
 tímido 25
 timón *m* 210, 241
 Timor Oriental 319
 tinta *f* 275
 tinte para el pelo *m* 40
 tinte para madera *m* 79
 tinto 145
 tintorería *f* 115
 tío *m* 22
 tipo de cambio *m* 97
 tipo de interés *m* 96
 tipos *m* 205
 tipos de autobuses *m* 196
 tipos de cámara *m* 270
 tipos de granja *m* 183
 tipos de pesca *m* 245
 tipos de plantas *m* 86
 tipos de tren *m* 208
 tirador *m* 200
 tirante *m* 35
 tirar 223, 227
 tirar al hoyo con un putter *m* 233
 tirar de cabeza 222
 tirarse de cabeza 238
 tirarse en trineo 247
 tirita *f* 47
 tiro *m* 249
 tiro con arco *m* 249
 tiro con efecto *m* 230
 tiro libre *m* 222
 tirón *f* 239
 tirón en el cuello *m* 46
 título *m* 168
 tiza *f* 162, 288
 toalla de ducha *f* 73
 toalla de lavabo *f* 73
 toalla de playa *f* 265
 toallas *f* 73
 toallero *m* 72
 toallita antiséptica *f* 47
 toallita húmeda *f* 108
 toallitas húmedas *f* 75
 tobillo *m* 13, 15
 tobogán *m* 263
 tocadiscos *m* 268
 tocador *m* 71
 tocólogo *m* 52
 todoterreno *m* 199
 toffee *m* 113
 toga *f* 169
 Togo 317
 tolo *m* 148
 toma *f* 61
 toma de tierra *f* 60
 toma del agua *f* 61
 tomar apuntes 163
 tomar el sol 264
 tomate *m* 125, 157
 tomate cherry *m* 124
 tomillo *m* 133
 tonelada *f* 310
 tónica *f* 144
 tónico *m* 41
 tono *m* 41, 256
 topacio *m* 288
 topinambur *m* 125
 torcedura *f* 46
 tormenta *f* 287
 tornador *m* 287
 tornear 79
 torneo *m* 233
 tornillo *m* 80
 tornillos de la rueda *m* 203
 torno de alfarero *m* 275
 torno de banco *m* 78
 torno de dentista *m* 50
 toro *m* 185
 torre *f* 272, 300
 torre de control *f* 212
 torre de vigilancia *f* 265
 torreón *m* 300
 trajo *m* 151
 traje *m* 255
 traje de baño *m* 238
 traje de buzo *m* 239
 traje de chaqueta *m* 32
 traje de cuero *m* 205
 traje de noche *m* 34
 traje espacial *m* 281
 traje minifaldero *m* 34
 trampolín *m* 235, 238
 transatlántico *m* 215
 transferencia bancaria *f* 96
 transformador *m* 60
 transmisión *f* 202
 transmisión por secuencias *f* 269
 transplantar 91
 transportador *m* 165
 transporte *m* 194
 tranvía *m* 196, 208
 trapecio *m* 16, 164
 trapo del polvo *m* 77
 tráquea *f* 18
 trasbordador espacial *m* 281
 traspaso *m* 223
 traste *f* 258
 tratamientos *m* 23
 tratamientos de belleza *m* 41
 trébol *m* 273, 297
 trece 308
 treinta 308
 trementina *f* 83
 tren *m* 208
 tren de alta velocidad *m* 208
 tren de aterrizaje *m* 210
 tren de mercancías *m* 208
 tren de vapor *m* 208
 tren delantero *m* 210
 tren diesel *m* 208
 tren eléctrico *m* 208
 tren intercity *m* 209
 trenca *f* 31
 trenza *f* 39
 tres 308
 trescientos 308
 triángulo *m* 164, 257
 tribuna del jurado *f* 180
 tríceps *m* 16
 trigésimo 309
 trigo *m* 130, 184
 trigo partido *m* 130
 trimestre *m* 52
 trineo con perros *m* 247
 Trinidad y Tobago 314
 trípode *m* 166, 270, 281
 tripulación *f* 241
 triste 25
 triturador de basuras *m* 61
 trocitos de chocolate *m* 141
 trolebus *m* 196
 trombón de varas *m* 257
 trompa *f* 291
 trompa de Falopio *f* 20
 trompeta *f* 257
 trona *f* 75
 tronco *m* 296
 trópico de Cáncer *m* 283
 trópico de Capricornio *m* 283
 trópicos *m* 283
 troposfera *f* 286
 trote *m* 243
 trozo *m* 140
 trucha *f* 120
 trucha arco iris *f* 120
 trueno *m* 286
 trufa *f* 113, 125
 tuba *f* 257
 tubo *m* 112, 202, 239, 311
 tubo de desagüe *m* 61
 tubo de ensayo *m* 166
 tubo de escape *m* 203, 204
 tubo de la aspiradora *m* 77
 tubo superior *m* 207
 tuerca *f* 80
 tulipán *m* 111
 Túnez 317
 turbo *m* 203
 turismo *m* 199, 260
 turista *m* 260
 Turkmenistán 318
 turmalina *f* 288
 turno *m* 228, 273
 turquesa *f* 289
 Turquía 316
 turrón *m* 113
 tutú *m* 191

U

Ucrania 316
 Uganda 317
 ugli *m* 126
 última mano *f* 83
 último piso *m* 141
 ultraligero *m* 211
 ultramarinos *m* 114
 ultrasonido *m* 52
 un cuarto de hora 304
 una media hora 304
 undécimo 309
 unidad de cuidados
 intensivos *f* 48
 uniforme *m* 94, 189, 222
 uniforme de rugby *m* 221
 uniforme del equipo *m* 31
 universidad *f* 299
 universo *m* 280
 uno 308
 uña *f* 15
 uña del pie *f* 15
 Urano *m* 280
 uréter *m* 21
 uretra *f* 20
 urgencia *f* 46
 urinario 19
 urología *f* 49
 Uruguay 315
 usar el hilo dental 50
 utensilios de cocina *m*
 68
 útero *m* 20, 52
 Uzbekistán 318

V

vaca *f* 185
 vacaciones *f* 212
 vacío 321
 vagina *f* 20
 vagón *m* 208, 209
 vagón restaurante *m* 209
 vaina *f* 122
 vainilla *f* 132
 vajilla *f* 64
 vajilla y los cubiertos *f, m*
 65
 vajillas *f* 105
 vale 322
 valla *f* 85, 243
 valle *m* 284
 valor de las acciones *m*
 97
 valor nominal *f* 97
 válvula *f* 207
 válvula de la presión *f* 61
 Vanuatu 319
 vaquería *f* 183
 varicela *f* 44
 varilla de cristal *f* 167
 varilla del nivel del aceite *f*
 202
 vaso *m* 65
 vaso de precipitados *m*
 167
 vecino *m* 24
 vehículo de servicio *m*
 212
 veinte 308
 veinte mil 309
 veinte minutos 304
 veintidós 308
 veintiuno 308
 vejiga *f* 20
 vela *f* 240, 241
 vela mayor *f* 240
 velas de cumpleaños *f*
 141
 vellón *m* 74
 velo 35
 vena *f* 19
 venado *m* 118
 venda *f* 47
 vendaje *m* 47
 vendedor de golosinas *m*
 113
 vendedor de periódicos *m*
 112
 Venezuela 315
 ventaja *f* 230
 ventana *f* 58, 177, 186
 ventana de la buhardilla *f*
 58
 ventana de la nariz *f* 14
 ventanilla *f* 96, 98, 197,
 209, 210
 ventanilla de pasajes *f*
 216
 ventarrón 286
 ventilador *m* 60, 202, 210
 ventosa *f* 53
 Venus 280
 ver la televisión 269
 verano *m* 31, 307
 verde 129, 274
 verdulería *f* 114
 verdura *f* 107
 verduras *f* 122, 124
 veredicto *m* 181
 vértebras cervicales *f* 17
 vértebras dorsales *f* 17
 vértebras lumbares *f* 17
 vesícula seminal *f* 21
 vespa *f* 205
 vestíbulo *m* 59, 100,
 209, 255
 vestido *m* 31, 34
 vestido de novia *m* 35
 veterinaria *f* 189
 vía *f* 208
 vía de acceso *f* 194
 vía de salida *f* 194
 viaje de negocios *m* 175
 viajero de cercanías *m*
 208
 vibráfono *m* 257
 videojuego *m* 269
 videoteléfono *m* 99
 vieira *f* 121
 viejo 321
 viento *m* 241, 286
 viento-madera *m* 257
 viento-metal *m* 256
 viernes 306
 Viet Nam 318
 viga de acero *f* 186

viga de madera *f* 186
 viga del tejado *f* 186
 vigésimo 309
 vigésimo primero 309
 vigésimo segundo 309
 vigésimo tercero 309
 vinagre *m* 135, 142
 vinagre balsámico *m* 135
 vinagre de malta *m* 135
 vinagre de sidra *m* 135
 vinagre de vino *m* 135
 vino *m* 145, 151
 vino de jerez *m* 145
 vino de oporto *m* 145
 viña *f* 183
 viñedo *m* 183
 viola *f* 256
 violín *m* 256
 violoncelo *m* 256
 virar 241
 virus *m* 44
 virutas de madera *f* 78
 visado *m* 213
 visera *f* 205
 visillo *m* 63
 visita *f* 45
 visita con guía *f* 260
 visor *m* 271
 vista *f* 51
 vitaminas *f* 108
 vivero *m* 115
 vivienda de una planta *f*
 58
 vivienda urbana *f* 58
 vodka *m* 145
 vodka con naranja *m* 151
 volante *m* 49, 201, 231
 volante a la derecha *m*
 201
 volante a la izquierda *m*
 201
 volar 211
 volcán *m* 283
 volcar 241
 volea *f* 231
 voltaje *m* 60
 voltereta lateral *f* 235
 volumen *m* 165, 179,
 269, 311
 vomitar 44
 vuelo con ala delta *m*
 248
 vuelo internacional *m*
 212
 vuelo nacional *m* 212
 vuelo sin motor *m* 248

W

wáter *m* 72
 waterpolo *m* 239
 wedge *m* 233
 whisky *m* 145
 whisky escocés con
 agua *m* 151
 WiFi *m* 269
 windsurfing *m* 241
 windsurfista *m* 241
 wok *m* 69

Y

yarda *f* 310
 yate *m* 215, 240
 yema *f* 137, 157
 Yemen 318
 yerno *m* 22
 yeso *m* 83
 yoga *m* 54
 yogurt *m* 137
 yogurt de frutas *m* 157
 yogurt helado *m* 137
 Yugoslavia 316

Z

zafiro *m* 288
 Zambia 317
 zanahoria *f* 124
 zapatería *f* 114
 zapatilla deportiva *f* 37
 zapatillas *f* 31, 251
 zapatillas de deporte *f*
 31
 zapato de caballero *m*
 37
 zapato de cordoneras *m*
 37
 zapato de golf *m* 233
 zapato de tacón *m* 37
 zapatos *m* 34, 37
 zapatos de piel *m* 32
 zarpa *f* 291
 zarpar 217
 Zimbabwe 317
 zinc *m* 289
 zodiac *m* 215
 zona *f* 315
 zona de abastecimiento *f*
 199
 zona de ataque *f* 224
 zona de defensa *f* 224
 zona de marca *f* 221
 zona final *f* 220
 zona industrial *f* 299
 zona lumbar *f* 13
 zona neutral *f* 224
 zona peatonal *f* 299
 zona poco profunda *f*
 239
 zona profunda *f* 239
 zonas *f* 283, 299
 zoo *m* 262
 zoología *f* 169
 zorro *m* 290
 zumo *m* 127
 zumo de frutas *m* 156
 zumo de manzana *m*
 149
 zumo de naranja *m* 148
 zumo de piña *m* 149
 zumo de tomate *m* 144,
 149
 zumo de uva *m* 144
 zumos y los batidos *m*
 149
 zurcir 277

índice inglés • English index

A

- à la carte 152
 abdomen 12
 abdominals 16
 above 320
 acacia 110
 accelerator 200
 accessories 36, 38
 accident 46
 account number 96
 accountant 97, 190
 accounts department 175
 accused 180
 ace 230, 273
 Achilles tendon 16
 acorn squash 125
 acquaintance 24
 acquitted 181
 across 320
 acrylic paints 274
 actions 237, 229, 227, 233, 183
 activities 263, 245, 162, 77
 actor 254, 191
 actors 179
 actress 254
 acupressure 55
 acupuncture 55
 Adam's apple 19
 add v 165
 address 98
 adhesive tape 47
 adjustable wrench 80
 admission charge 260
 admissions office 168
 admitted 48
 aduki beans 131
 adult 23
 advantage 230
 adventure 255
 advertisement 269
 aerate v 91
 Afghanistan 318
 Africa 317
 after 320
 afternoon 305
 aftershave 73
 after-sun 108
 agate 289
 agenda 174
 aikido 236
 aileron 210
 air bag 201
 air conditioning 200
 air cylinder 239
 air filter 202, 204
 air letter 98
 air mattress 267
 air vent 210
 aircraft 210
 aircraft carrier 215
 airliner 210, 212
 airport 212
 aisle 106, 168, 210, 254
 alarm clock 70
 Alaska 314
 Albania 316
 alcoholic drinks 145
 alfalfa 184
 Algeria 317
 all-purpose flour 139
 allergy 44
 alley 298
 alligator 293
 alligator clip 167
 allspice 132
 almond 129
 almond oil 134
 almonds 151
 along 320
 alpine 87
 alpine skiing 247
 alternating current 60
 alternative therapy 54
 alternator 203
 altitude 211
 aluminum 289
 Amazonia 312
 ambulance 94
 amethyst 288
 amniocentesis 52
 amniotic fluid 52
 amount 96
 amp 60
 amphibians 294
 amplifier 268
 analog (radio) 179
 anchor 214, 240
 Andes 312
 Andorra 316
 anesthetist 48
 angle 164
 angler 244
 Angola 317
 angry 25
 animals 292, 294
 animated film 255
 ankle 13, 15
 ankle-length 34
 anniversary 26
 annual 86, 307
 answer 163
 answer v 99, 163
 answering machine 99
 ant 295
 antenna 295
 antifreeze 199, 203
 Antigua and Barbuda 314
 anti-inflammatory 109
 antique shop 114
 antiseptic 47
 antiseptic wipe 47
 anti-wrinkle 41
 antler 291
 apartment building 298
 apéritif 153
 aperture dial 270
 apex 165
 app 99
 appeal 181
 appearance 30
 appendix 18
 applaud v 255
 apple 126
 apple corer 68
 apple juice 149
 appliances 66
 application 176
 appointment 45, 175
 apricot 126
 April 306
 apron 30, 50, 69, 212
 aquamarine 288
 Arabian Sea 313
 arc 164
 arch 15, 85, 301
 archery 249
 architect 190
 architecture 300
 architrave 301
 Arctic Circle 283
 Arctic Ocean 312
 area 165, 310
 areas 299
 arena 243
 Argentina 315
 arithmetic 165
 arm 13
 armband 238
 armchair 63
 Armenia 318
 armpit 13
 armrest 200, 210
 aromatherapy 55
 around 320
 arrangements 111
 arrest 94
 arrivals 213
 arrow 249
 art 162
 art college 169
 Art Deco 301
 art gallery 261
 art history 169
 Art Nouveau 301
 art shop 115
 artery 19
 artichoke 124
 artist 274
 arts and crafts 274, 276
 ash 283
 ashtray 150
 Asia 318
 asparagus 124
 asphalt 187
 assault 94
 assistant 24
 assisted delivery 53
 asteroid 280
 asthma 44
 astigmatism 51
 astronaut 281
 astronomy 281
 asymmetric bars 235
 at 320
 athlete 234
 athletic shoes 31, 251
 Atlantic Ocean 312
 ATM 97
 atmosphere 282, 286
 atrium 104
 attachment 177
 attack 220
 attack zone 224
 attend v 174
 attic 58
 attractions 261
 auburn 39
 audience 254
 August 306
 aunt 22
 aurora 286
 Australasia 319
 Australia 319
 Austria 316
 automatic 200
 automatic door 196
 automatic payment 96
 avalanche 247
 avenue 299
 avocado 128
 awning 148
 ax 95
 axle 205
 ayurveda 55
 Azerbaijan 318
B
 baby 23, 30
 baby bath 74
 baby care 74
 baby changing facilities 104
 baby monitor 75
 baby products 107
 baby sling 75
 back 13
 back brush 73
 back seat 200
 back up v 195
 backboard 226
 backdrop 254
 backgammon 272
 backhand 231
 backpack 31, 37, 267
 backslash 66
 backstroke 239
 backswing 233
 bacon 118, 119, 157
 bad 321
 badge 94, 189
 badminton 231
 bag 311
 bagel 139
 baggage claim 213
 baggage trailer 212
 bags 37
 baguette 138
 Bahamas 314
 bail 181
 bailiff 180
 bait 244
 bait v 245
 bake v 67, 138
 baked 159
 baker 139
 baker's 114
 bakery 107, 114, 138
 baking 69
 baking sheet 69
 balance wheel 276
 balcony 59, 254
 bald 39
 bale 184
 Balearic Islands 316
 ball 15, 75, 221, 224, 226, 228, 230
 ball boy 231
 ballet 255
 balsamic vinegar 135
 Baltic Sea 313
 bamboo 86, 122
 banana 128
 bandage 47
 Bangladesh 318
 banister 59
 bank 96, 284
 bank charge 96
 bank manager 96
 bank transfer 96
 bar 150, 152, 250, 256, 311
 bar code 106
 bar counter 150
 bar mitzvah 26
 bar snacks 151
 bar stool 150
 barb 244
 Barbados 314
 barbecue 267
 barber 39, 188
 bark 296

- barley 130, 184
 barn 182
 baroque 301
 bars 74
 bartender 150, 191
 basalt 288
 base 164, 229
 base station 99
 baseball 228
 baseline 230
 baseman 228
 basement 58
 basil 133
 basket 106, 207, 226
 basket of fruit 126
 basketball 226
 basketball player 226
 basque 35
 bass clarinet 257
 bass clef 256
 bass guitar 258
 bassinet 74
 bassoon 257
 bat 225, 228, 231, 290
 bat v 225, 229
 bath mat 72
 bath towel 73
 bathrobe 31, 32, 73
 bathroom 72
 bathtub 72
 baton 235, 256
 batsman 225
 batter 228
 batteries 260
 battery 167, 202
 battery pack 78
 battleship 215
 bay leaf 133
 be born v 26
 beach 264
 beach bag 264
 beach ball 265
 beach hut 264
 beach towel 265
 beach umbrella 264
 beaker 167
 beam 186, 235
 bean sprout 122
 beans 131, 144
 bear 291
 beat 259
 beauty 40, 105
 beauty treatments 41
 bed 70
 bed and breakfast 101
 bed linen 71
 bedding 74
 bedroom 70
 bedside lamp 70
 bedspread 70
 bee 295
 beech 296
 beef 118
 beer 145, 151
 beer tap 150
 beetle 295
 beet 125
 before 320
 beginning 321
 behind 320
 Belarus 316
 Belgium 316
 Belize 314
 bell 197
 below 320
 belt 32, 36, 236
 bench 250, 262
 Benin 317
 berry 296
 beside 320
 bet 273
 between 320
 beyond 320
 Bhutan 318
 biathlon 247
 bih 30
 biceps curl 251
 biceps 16
 bicycle 206
 bidet 72
 biennial 86
 bifocal 51
 big toe 15
 bike rack 207
 bikini 264
 bill 152, 293
 binoculars 281
 biology 162
 biplane 211
 birch 296
 bird-watching 263
 birds 292
 birth 52
 birth weight 53
 birth certificate 26
 birthday 27
 birthday cake 141
 birthday candles 141
 birthday party 27
 bishop 272
 bit 242
 bit brace 78
 bite 46
 bite v 245
 bitter 124, 145
 black 39, 272, 274
 black belt 237
 black coffee 148
 black currant 127
 black hole 280
 black olive 143
 black pudding 157
 Black Sea 313
 black tea 149
 blackberry 127
 blackboard 162
 black-eyed beans 131
 bladder 20
 blade 60, 66, 78, 89
 blanket 71, 74
 blazer 33
 bleach 77
 blender 66
 blinder 46
 block 237
 block v 227
 blonde 39
 blood pressure 44
 blood pressure gauge 45
 blood test 48
 blouse 34
 blow-dry v 38
 blow out v 141
 blowhole 290
 blue 274
 blue cheese 136
 bluebells 297
 blueberry 127
 blues 259
 blusher 40
 board 241
 board v 217
 board games 272
 boarding pass 213
 boardwalk 265
 bob 39
 bobbin 276
 bobsled 247
 body 12
 body lotion 73
 body systems 19
 bodywork 202
 boil v 67
 boiled egg 137, 157
 Bolivia 315
 bollard 214, 298
 bolt 59
 bomber 211
 bone 17, 119, 121
 bone meal 88
 boned 121
 bongos 257
 book 168
 bookstore 115
 bookshelf 63, 168
 boom 95, 240
 booster 281
 boot 37
 booties 30
 bored 25
 borrow v 168
 Bosnia and Herzegovina 316
 Botswana 317
 bottle 61, 75, 135, 311
 bottle opener 68, 150
 bottled foods 134
 bottled water 144
 bottom tier 141
 boundary line 225
 bouquet 35, 111
 bouquet garni 132
 bout 237
 boutique 115
 bow 240, 249
 bow tie 36
 bowl 61, 65, 112
 bowl v 225
 bowler 225
 bowling 249
 bowling ball 249
 box 254
 box file 173
 box of chocolates 113
 box of tissues 70
 box office 255
 boxer shorts 33
 boxercise 251
 boxing 236
 boxing gloves 237
 boxing ring 237
 boy 23
 boyfriend 24
 bra 35
 braces 50
 bracelet 36
 braid 39
 brain 19
 brake 200, 204, 206
 brake v 207
 brake block 207
 brake fluid reservoir 202
 brake lever 207
 brake pedal 205
 bran 130
 branch 296
 brandy 145
 brass 256
 Brazil 315
 Brazil nut 129
 bread 157
 bread flour 139
 bread knife 68
 bread roll 143
 breadcrumbs 139
 breadfruit 124
 breads 138
 break a record v 234
 break water v 52
 breakdown 203
 breakfast 64, 156
 breakfast buffet 156
 breakfast cereals 107
 breakfast table 156
 breakfast tray 101
 breast 12, 119
 breast pump 53
 breastbone 17
 breastfeed v 53
 breaststroke 239
 breathing 47
 breech 52
 brick 187
 bridge 15, 214, 258, 273, 300
 bridle 242
 bridle path 263
 brie 142
 briefcase 37
 briefs 33, 35
 brioche 157
 broadcast 179
 broadcast v 178
 broccoli 123
 brochure 96, 175
 brogue 37
 broil v 67
 bronze 235
 brooch 36
 broom 77
 broth 158
 brother 22
 brother-in-law 23
 browband 242
 brown 274
 brown bread 139, 149
 brown flour 138
 brown lentils 131
 brown rice 130
 browse v 177
 browser 177
 bruise 46
 Brunei 319
 brunette 39
 brush 38, 40, 77, 83, 274
 brush v 38, 50
 Brussels sprout 122
 bubble bath 73
 buckle 36
 bud 111, 297
 buffet 152
 build v 186
 building site 186
 buildings 299
 built-in wardrobe 71
 bulb 86
 Bulgaria 316
 bull 185
 bulldog clip 173
 bullnose pliers 80
 bullseye 273
 bumper 74, 198
 bun 39, 140, 139, 155
 bunch 111
 bungalow 58
 bungee jumping 248
 bunker 232
 bunsen burner 166
 buoy 217
 bureau de change 97
 burger 154
 burger bar 154
 burger meal 154
 burglar alarm 58
 burglary 94
 Burkina Faso 317
 Burma (Myanmar) 318
 burn 46
 burner 67

- Burundi 317
 bus 196
 bus driver 190
 bus stop 197
 bus station 197
 bus stop 197, 299
 bus ticket 197
 buses 196
 business 175
 business class 211
 business deal 175
 business lunch 175
 business partner 24
 business suit 32
 business trip 175
 businessman 175
 businesswoman 175
 busy 99
 butcher 118, 188
 butcher shop 114
 butter 137, 156
 butter beans 131
 buttercup 297
 butterfly 239, 295
 buttermilk 137
 butternut squash 125
 buttock 13, 16
 button 32
 buttonhole 32
 buttress 301
 by 320
 by airmail 98
 bytes 176
- C**
 cab 95
 cab driver 190
 cabbage 123
 cabin 210, 214
 Cabinda 317
 cable 79, 207
 cable car 246
 cable television 269
 cactus 87
 caddy 233
 cesarean section 52
 café 148, 262
 cafeteria 168
 cafetière 65
 cake pan 69
 cakes 140
 calcite 289
 calcium 109
 calculator 165
 calendar 306
 calf 13, 16, 185
 call button 48
 calyx 297
 cam belt 203
 Cambodia 318
 camcorder 260, 269
 camel 291
 camembert 142
 camera 178, 260, 270
 camera case 271
 camera crane 178
 camera shop 115
 cameraman 178
 cameraphone 270
 Cameroon 317
 camisole 35
 camp v 266
 camp bed 266
 campari 145
 camper van 266
 campfire 266
 camping 266
 camping stove 267
 campground 266
 campus 168
 can 145, 289, 311
 can opener 68
 Canada 314
 canary 292
 candied fruit 129
 candy 113
 candy store 113
 cane 91
 canes 89
 canine 50
 canned drink 154
 canned food 107
 canoe 214
 canoeing 241
 canola oil 135
 canter 243
 canvas 274
 cap 21, 36, 238
 capacity 311
 cape gooseberry 128
 capers 143
 capital 315
 capoeira 237
 cappuccino 148
 capsize v 241
 capsule 109
 captain 214
 car 198, 200
 car accident 203
 car rental 213
 car seat 198, 207
 car stereo 201
 car wash 198
 caramel 113
 caraway 131
 card 27
 card slot 97
 cardamom 132
 cardboard 275
 cardigan 32
 cardiology 49
 cardiovascular 19
 cards 273
 cargo 216
 Caribbean Sea 312
 carnation 110
 carnival 27
 carousel 212
 carpenter 188
 carpentry bits 80
 carpet 71
 carriage race 243
 carrier 75, 204
 carrot 124
 carry-on luggage 211, 213
 cart 48, 100, 106, 208, 213
 cartilage 17
 cartoon 311
 cartoon 178
 carve v 79
 carving fork 68
 case 51
 cash v 97
 cashew 129
 cashews 151
 cashier 96, 106
 casino 261
 Caspian Sea 313
 cassava 124
 casserole dish 69
 cassette player 269
 cassette tape 269
 cast 254
 cast v 245
 castle 300
 casual 34
 casual wear 33
 cat 290
 catamaran 215
 cataract 51
 catch v 220, 227, 229, 245
 catcher 229
 caterpillar 295
 cathedral 300
 catheter 53
 cauliflower 124
 cave 284
 CD 269
 CD player 268
 cedar 296
 ceiling 62
 celebration 140
 celebration cakes 141
 celebrations 27
 celeriac 124
 celery 122
 cell 94, 181
 cell phone 99
 cello 256
 cement 186
 cement mixer 186
 centimeter 310
 centipede 295
 Central African Republic 317
 central reservation 194
 center 164
 center circle 222, 224, 226
 center field 228
 center line 226
 centerboard 241
 century 307
 CEO 175
 ceramic range 66
 cereal 130, 156
 cervical vertebrae 17
 cervix 20, 52
 Chad 317
 chain 36, 206
 chair 64
 chair v 174
 chairlift 246
 chalk 85, 162, 288
 chamber 283
 chamomile tea 149
 champagne 145
 championship 230
 change v 209
 change a tire v 203
 change channels v 269
 change gears v 207
 changing mat 74
 changing room 104
 channel 178
 charcoal 266, 275
 charge 94, 180
 chart 48
 chassis 203
 check 96
 checkbook 96
 checkers 272
 check-in v 212
 check-in desk 213
 checking account 96
 checkout 106
 checkup 50
 cheddar 142
 cheek 14
 cheerleader 220
 cheese 136, 156
 chef 152, 190
 chef's hat 190
 chemistry 162
 cherry 126
 cherry tomato 124
 chess 272
 chessboard 272
 chest 12
 chest of drawers 70
 chest press 251
 chestnut 129
 chicken gum 113
 chick 185
 chicken 119, 185
 chicken burger 155
 chicken coop 185
 chicken nuggets 155
 chicken pox 44
 chicory 122
 child 23, 31
 child lock 75
 childbirth 53
 children 23
 children's clothing 30
 children's department 104
 children's meal 153
 children's ward 48
 Chile 315
 chili pepper 124, 132, 143
 chill 44
 chimney 58
 chin 14
 China 318
 china 105
 chip v 233
 chips 113, 151
 chipboard 79
 chiropractic 54
 chisel 81, 275
 chives 133
 chocolate 113
 chocolate bar 113
 chocolate cake 140
 chocolate chip 141
 chocolate-coated 140
 chocolate milkshake 149
 chocolate spread 135
 choir 301
 choke v 47
 chop 119, 237
 chorizo 143
 choux pastry 140
 christening 26
 Christmas 27
 chrysanthemum 110
 chuck 78
 church 298, 300
 chutney 134
 cider 145
 cider vinegar 135
 cigar 112
 cigarettes 112
 cilantro 133
 cinnamon 133
 circle 165, 254
 circular saw 78
 circuit training 251
 circulation desk 168
 circumference 164
 citrus fruit 126
 city 299
 clam 121
 clamp 78, 166
 clamp stand 166
 clapper board 179
 clarinet 257
 clasp 36
 classical music 255, 259
 classroom 162
 claw 291
 clay 85, 275
 clean v 77
 clean clothes 76

- cleaned 121
 cleaner 188
 cleaning equipment 77
 cleaning fluid 51
 cleanser 41
 clear honey 134
 cleat 240
 cleaver 68
 clementine 126
 client 38, 175, 180
 cliff 285
 climber 87
 climbing frame 263
 clinic 48, 168
 clipboard 173
 clitoris 20
 clock radio 70
 closed 260, 321
 cloth diaper 30
 clothesline 76
 clothespin 76
 clothing 205
 cloud 287
 cloudy 286
 clove 125
 clover 297
 cloves 133
 club 273
 club sandwich 155
 clubhouse 232
 clutch 200, 204
 coach 196
 coal 288
 coast 285
 coaster 150
 coastguard 217
 coat 32
 coat hanger 70
 cockatoo 293
 cockle 121
 cockpit 210
 cockroach 295
 cocktail 151
 cocktail shaker 150
 cocoa powder 148
 coconut 129
 cocoon 295
 cod 120
 coffee 144, 148, 153, 156, 184
 coffee cup 65
 coffee machine 148, 150
 coffee milkshake 149
 coffee spoon 153
 coffee table 62
 cog 206
 coin 97
 coin phone 99
 coin return 99
 cola 144
 colander 68
 cold 44, 286, 321
 cold faucet 72
 cold-pressed oil 135
 collage 275
 collar 32
 collarbone 17
 colleague 24
 collect call 99
 collection 98
 college 168
 cologne 41
 Colombia 315
 colony 315
 colored pencil 163
 colors 39, 274
 comb 38
 comb v 38
 combat sports 236
 combine 185
 comedy 255
 comforter 71
 comet 280
 comic 112
 commis chef 152
 commission 97
 communications 98
 commuter 208
 Comoros 317
 compact 40
 compact car 199
 company 175
 compartment 209
 compass 165, 312, 240
 complaint 94
 complexion 41
 composite 181
 compost 88
 compost pile 85
 computer 176
 concealer 40
 conceive v 20
 conception 52
 concert 255, 258
 concourse 209
 concrete block 187
 concussion 46
 condensed milk 136
 conditioner 38
 condom 21
 conductor 256
 cone 164, 187
 confectionery 107, 113
 confident 25
 confused 25
 conglomerate 288
 Congo 317
 conifer 86
 connect v 177
 connection 212
 conning tower 215
 console 269
 constellation 281
 construction 186
 construction worker 186, 188
 consultant 49
 consultation 45
 contact lenses 51
 container 216, 311
 container port 216
 container ship 215
 continent 282, 315
 contraception 21, 52
 contraction 52
 control tower 212
 controller 269
 controls 201, 204
 convenience food 107
 convertible 199
 conveyer belt 106
 cooked meat 118, 143
 cookies 113, 141
 cooking 67
 coolant reservoir 202
 cooling rack 69
 co-pilot 211
 copper 289
 copy v 172
 cor anglais 257
 coral reef 285
 cordless drill 78
 cordless phone 99
 core 127
 cork 134
 corkscrew 150
 corn 122, 130, 184
 corn bread 139
 corn oil 135
 cornea 51
 corner 223
 corner flag 223
 cornice 300
 corset 35
 Corsica 316
 Costa Rica 314
 costume 255
 cottage cheese 136
 cottage garden 84
 cotton 184, 277
 cotton balls 41
 cough 44
 cough drop 109
 cough medicine 108
 counselor 55
 count v 165
 counter 96, 98, 100, 142, 272
 countertop 66
 country 259, 315
 couple 24
 courier 99
 courses 153
 court 226
 court case 180
 court clerk 180
 court date 180
 courtroom 180
 courtyard 58, 84
 couscous 130
 cousin 22
 coverall 30
 cow 185
 cow's milk 136
 crab 121, 295
 cracked wheat 130
 cradle 95
 craft knife 82
 crafts 275
 cramp 239
 cramps 44
 cranberry 127
 crane 187, 216, 292
 crater 283
 crayfish 121
 cream 109, 137, 140, 157
 cream cheese 136
 cream pie 141
 crease 225
 credit card 96
 creel 245
 creeper 87
 crème caramel 141
 crème patisserie 140
 crêpe 155, 157
 crescent moon 280
 crew 241
 crew hatch 281
 crib 74
 cricket 225, 295
 cricket ball 225
 cricketer 225
 crime 94
 criminal 181
 criminal record 181
 crisp 127
 crispbread 139, 156
 crisper 67
 Croatia 316
 crochet 277
 crochet hook 277
 crockery 64
 crockery and cutlery 65
 crocodile 293
 croissant 156
 crop 39, 183
 crop farm 183
 crops 184
 crossbar 207, 222, 235
 cross-country skiing 247
 cross-trainer 250
 crosswalk 195
 crow 292
 crown 50
 crucible 166
 crushed 132
 crust 139, 282
 cry v 25
 crystal healing 55
 Cuba 314
 cube 164
 cucumber 125
 cuff 32, 45
 cufflink 36
 cultivate v 91
 cultivator 182
 cumin 132
 curb 298
 cured 118, 159, 143
 curler 38
 curling 247
 curly 39
 currant 129
 curry 158
 curry powder 132
 curtain 63, 254
 curved 165
 cushion 62
 custard 140
 customer 96, 104, 106, 152
 customer service department 175
 customer services 104
 customs 212
 customs house 216
 cut 46
 cut v 38, 79, 277
 cuticle 15
 cutlery 64
 cuts 119
 cutting 91
 cutting board 68
 cuttlefish 121
 cycle v 207
 cycle lane 206
 cycling 263
 cylinder 164
 cylinder head 202
 cymbals 257
 Cyprus 316
 Czech Republic 316

D

- daffodil 111
 dairy 107
 dairy farm 183
 dairy produce 136
 daisy 110, 297
 dam 300
 dance 259
 dance academy 169
 dancer 191
 dandelion 123, 297
 dandruff 39
 dark 41, 321
 darkroom 271
 darn v 277
 dartboard 273
 darts 273
 dashboard 201
 date 129, 306
 daughter 22

- daughter-in-law 22
dawn 305
day 305, 306
day after tomorrow 307
day before yesterday 307
dead ball line 221
deadhead *v* 91
deal *v* 273
debit card 96
decade 307
decay 50
December 306
deciduous 86
decimal 165
deck 214
deck chair 265
deck of cards 273
decking 85
decorating 82
decoration 141
decorator 82
deep end 239
deep-fried 159
deep-sea fishing 245
deer 291
defense 181, 220
defendant 181
defender 223
defending zone 224
defrost *v* 67
degree 169
delay 209
deli 107
delicatessen 142
delivery 52, 98
deltoid 16
Democratic Republic of the Congo 317
Denmark 316
denomination 97
denominator 165
dental care 108
dental floss 50, 72
dental hygiene 72
dental X-ray 50
dentist 50, 189
dentist's chair 50
dentures 50
deodorant 73, 108
department 169
department store 105
departments 49
departure lounge 213
departures 213
deposit *v* 96
deposit slips 96
depth 165
dermatology 49
descaled 121
desert 285
desiccated 129
designer 191, 277
desk 162, 172
desktop 177
dessert 153
desserts 140
dessert cart 152
destination 213
detached 58
detective 94
detergent 77
detour 195
deuce 230
develop *v* 271
diabetes 44
diagonal 164
dial *v* 99
diameter 164
diamond 273, 288
diaper 75
diaper bag 75
diaper rash cream 74
diaphragm 19, 21
diarrhea 44, 109
dice 272
dictionary 163
die *v* 26
diesel 199
diesel train 208
difficult 321
dig *v* 90, 227
digestive 19
digital 269
digital (radio) 179
digital camera 270
digital projector 163
digital radio 268
dilation 52
dill 133
dimensions 165
dimple 15
dining car 209
dining room 64
dinner 64, 158
dinner plate 65
diopter 51
diploma 169
dipstick 202
direct current 60
directions 260
director 254
directory assistance 99
dirt bike 205
dirty laundry 76
disabled parking 195
discharged 48
disconnected 99
discus 234
discuss *v* 163
disembark *v* 217
dishwasher 66
disinfectant solution 51
disposable 109
disposable camera 270
disposable diaper 30
disposable razor 73
dissertation 169
distance 310
distributor 203
district 315
dive 239
dive *v* 238
diver 238
divide *v* 165
divided by 165
divided highway 195
dividends 97
divider 173, 194
divorce 26
Diwali 27
DJ 179
Djibouti 317
do not bend *v* 98
dock 214, 216
dock *v* 217
doctor 45, 189
doctorate 169
documentary 178
dog 290
dog-sledding 247
doll 75
dollhouse 75
dolphin 290
dome 300
domestic flight 212
Dominica 314
Dominican Republic 314
dominoes 273
donkey 185
door 196, 198, 209
door chain 59
door knob 59
door knocker 59
door lock 200
doorbell 59
doormat 59
dormer 58
dorsal fin 294
dosage 109
double 151
double bass 256
double bassoon 257
double bed 71
double room 100
double-decker bus 196
doubles 230
dough 138
Dover sole 120
down 320
downhill skiing 247
download *v* 177
dragonfly 295
drain 61, 72, 299
drain cock 61
drainage 91
draining board 67
draw 223
draw *v* 162
drawer 66, 70, 172
drawing 275
dress 31, 34
dressage 243
dressed 159
dressed chicken 119
dressing 47, 158
dressing table 71
dribble *v* 223, 227
dried flowers 111
dried fruit 156
drill 50
drill *v* 79
drill bit 78
drill bits 80
drinking cup 75
drinking fountain 262
drinks 107, 144, 156
drip 53
drive *v* 195, 233
driver 196
driver's seat 196
driveshaft 202
drop anchor *v* 217
dropper 109, 167
drops 109
dropshot 230
drown *v* 239
drum 258
drum kit 258
drummer 258
dry 39, 41, 130, 145, 286, 321
dry *v* 76
dry-cleaner 115
dry dock 217
DTV converter box 269
duck 119, 185
duck egg 137
duckling 185
duffle bag 37
duffle coat 31
dugout 229
dumb bell 251
dumper truck 187
dunk *v* 227
duodenum 18
duplex 58
dusk 305
dust *v* 77
dustpan 77
duster 77
dust sheet 83
duty-free shop 213
DVD 269
DVD player 268
dyed 39
dynamo 207
E
eagle 292
ear 14
early
earring 36
Earth 280, 282
earthenware dish 69
earthquake 283
easel 174, 274
east 312
East Timor 319
Easter 27
easy 321
easy cook 130
eat *v* 64
eat-in 154
eating 75
eaves 58
éclair 140
eclipse 280
economics 169
economy class 211
Ecuador 315
eczema 44
edam 142
edge 246
editor 191
eel 294
egg 20
egg cup 65, 137
egg white 137
eggplant 125
eggs 137
Egypt 317
eight 308
eight hundred 308
eighteen 308
eighteenth 309
eighth 309
eightieth 309
eighty 308
ejaculatory duct 21
El Salvador 314
elbow 13
electric blanket 71
electric blood pressure monitor 45
electric car 199
electric drill 78
electric guitar 258
electric meter 60
electric razor 73
electric shock 46
electric train 208
electrical goods 105, 107
electrician 188
electricity 60
elephant 291
elevator 59, 100, 104
eleven 308
eleventh 309
elm 296
email 98, 177
email account 177
email address 177
embarrassed 25
embossed paper 83
embroidery 277
embryo 52
emerald 288
emergency 46

- emergency exit 210
 emergency lever 209
 emergency phone 195
 emergency room 48
 emergency services 94
 emigrate *v* 26
 emotions 25
 employee 24
 employer 24
 empty 321
 enamel 50
 encore 255
 encyclopedia 163
 end 321
 end zone 220
 endive 123
 endline 226
 endocrine 19
 endocrinology 49
 energy-saving bulb (eco bulb) 60
 engaged couple 24
 engine 202, 204, 208, 210
 engine room 214
 engineering 169
 English breakfast 157
 English mustard 135
 engraving 275
 enlarge *v* 172
 enlargement 271
 ENT (otolaryngology) 49
 entrance 59
 entrée 153
 envelope 98, 173
 environment 280
 epidural 52
 epiglottis 19
 epilepsy 44
 episiotomy 52
 equals 165
 equation 165
 equator 283
 equipment 233, 238
 equipment 165
 Equatorial Guinea 317
 equity 97
 eraser 163
 Eritrea 317
 erupt *v* 283
 escalator 104
 esophagus 19
 espresso 148
 essay 163
 essential oils 55
 estate 199
 Estonia 316
 estuary 285
 Ethiopia 317
 eucalyptus 296
 Europe 316
 evening 305
 evening dress 34
 evening menu 152
 events 243, 247
 evergreen 86
 evidence 181
 excavator 187
 excess baggage 212
 exchange rate 97
 excited 25
 excuse me 322
 executive 174
 exercise bike 250
 exercises 251
 exfoliate *v* 41
 exhaust pipe 203, 204
 exhibit *v* 261
 exhibition 261
 exit 210
 exit ramp 194
 exosphere 286
 expanding file 173
 expectant 52
 experiment 166
 expiration date 109
 exposure 271
 express train 209
 extend *v* 251
 extension 58
 extension cord 78
 exterior 198
 external hard drive 176
 extra time 223
 extraction 50
 extractor 66
 eye 14, 51, 244, 276
 eye shadow 40
 eye test 51
 eyebrow 14, 51
 eyebrow brush 40
 eyebrow pencil 40
 eyecup 269
 eyelash 14, 51
 eyelet 37
 eyelid 51
 eyeliner 40
 eyepiece 167
F
 fabric 277
 fabric conditioner 76
 face 14
 face cream 73
 face mask 225
 face pack 41
 face powder 40
 faceoff circle 224
 facial 41
 factory 299
 faint *v* 25, 44
 fair 41
 fairground 262
 fairway 232
 falcon 292
 Falkland Islands 315
 fall 237
 fall (autumn) 31, 307
 fall in love *v* 26
 fallopian tube 50
 family 22
 famous ruin 261
 fan 60, 202
 fan belt 203
 fans 258
 far 320
 fare 197, 209
 farm 182, 183, 184
 farmer 182, 189
 farmhouse 182
 farmland 182
 farmyard 182
 farsightedness 51
 fashion 277
 fast 321
 fast food 154
 fast-forward 269
 fastening 37
 fat 119, 321
 fat-free 137
 father 22
 father-in-law 23
 fault 230
 fava beans 122, 131
 fax 98, 172
 fax machine 172
 feather 293
 feature film 269
 February 306
 feed *v* 183
 feijoa 128
 female 12, 20
 feminine hygiene 108
 femur 17
 fence 85, 182, 243
 fencing 249
 feng shui 55
 fennel 122, 133
 fennel seeds 133
 fenugreek 132
 fern 86
 ferry 215, 216
 ferry terminal 216
 fertilization 20
 fertilize *v* 91
 fertilizer 91
 festivals 27
 fetus 52
 fever 44
 fiancé 24
 fiancée 24
 fiancer 127
 fibula 17
 field 182, 222, 225, 228, 234, 258, 266
 field *v* 225, 229
 field hockey 224
 fifteen 308
 fifteenth 309
 fifth 309
 fiftieth 309
 fifty 308
 fifty five thousand, five hundred 309
 fifty thousand 309
 fig 129
 fighter plane 211
 figure skating 247
 figurine 260
 Fiji 319
 filament 60
 file 81, 177
 filing cabinet 172
 fill *v* 82
 filler 83
 fillet 119, 121
 filleted 121
 filling 50, 140, 155
 film chamber 270
 film spool 271
 filter 270
 filter coffee 148
 filter paper 167
 fin 210
 finance 97
 financial advisor 97
 fingerprint 94
 finial 300
 finish line 234
 Finland 316
 fire 95
 fire alarm 95
 fire department 95
 fire engine 95
 fire escape 95
 fire extinguisher 95
 fire station 95
 firefighter 95, 189
 firelighter 266
 fireplace 63
 firm 124
 first 309
 first aid 47
 first-aid box 47
 first night 254
 fish 107, 120, 294
 fish and chips 155
 fish farm 183
 fisherman 189
 fishhook 244
 fishing 244, 245
 fishing boat 217
 fishing permit 245
 fishing port 217
 fishing rod 244
 fish-seller 114, 120, 188
 fist 15, 237
 fitness 250
 five 308
 five hundred 308
 flag 221, 232
 flageolet beans 131
 flakes 132
 flamingo 292
 flan 142
 flare 240
 flash 270
 flash gun 270
 flashlight 267
 flask 166
 flat 59, 256
 flat race 243
 flat tire 203, 207
 flat wood bit 80
 flatbread 139
 flatscreen TV 269
 flavored oil 134
 flax 184
 fleece 74
 flesh 124, 127, 129
 flex *v* 251
 flight attendant 190, 210
 flight number 213
 flint 288
 flipchart 174
 flip-flop 37
 flipper 239, 290
 float 238, 244
 float ball 61
 flock 183
 flood 287
 floor 58, 62, 71
 floor exercises 235
 floor plan 261
 florentine 141
 fret 122
 florist 110, 188
 floss *v* 50
 flours 138
 flower 297
 flowerbed 85, 90
 flowering plant 297
 flowering shrub 87
 flowers 110
 flu 44
 flute 139, 257
 fly 244, 295
 fly *v* 211
 fly-fishing 245
 flysheet 266
 foal 185
 focus *v* 271
 focusing knob 167
 fog 287
 foil 249
 folder 177
 foliage 110
 folk music 259
 follicle 20
 font 177
 food 118, 130, 149
 food hall 105
 food processor 66
 foot 12, 15, 310
 foot pedals (instrument) 257
 football 220
 footboard 71
 footpath 262

formal 34
 formal garden 84, 262
 fortieth 309
 forty 308
 forty minutes
 forward 222
 foul 222, 226
 foul ball 228
 foul line 229
 foundation 40
 fountain 85
 four 308
 four hundred 308
 four-door 200
 fourteen 308
 fourteenth 309
 fourth 309
 four-wheel drive 199
 fox 290
 foxglove 297
 foyer 59
 fraction 165
 fracture 46
 fragile 98
 fragranced 130
 frame 51, 62, 206, 230, 269
 France 316
 freckle 15
 free 321
 free kick 222
 free-range 118
 free weights 250
 freesia 110
 free-throw line 226
 freeway 194
 freeze 287
 freeze v 67
 freezer 67
 freight train 208
 freighter 215
 French bean 122
 French braid 39
 french fries 154
 French Guiana 315
 French horn 257
 French mustard 135
 French toast 157
 frequency 179
 fresh 121, 127, 130
 fresh cheese 136
 fresh fruit 157
 freshwater fishing 245
 fret 258
 fretsaw 81
 Friday 306
 fried 159
 fried chicken 155
 fried egg 157
 friend 24
 frieze 301
 frog 294
 from 320
 front crawl 239

front door 58
 front wheel 196
 frontage road 194, 216
 frontal 16
 frost 287
 froth 148
 frown 25
 frozen 121, 124
 frozen food 107
 frozen yogurt 137
 fruit 107, 126, 128
 fruit bread 139
 fruit cake 140
 fruit farm 183
 fruit juice 127, 156
 fruit tart 140
 fruit yogurt 157
 fry v 67
 frying pan 69
 fuel gauge 201
 fuel tank 204
 full 64, 266, 321
 full board 101
 full moon 280
 fumble 220
 funeral 26
 funnel 166, 214
 furniture store 115
 furrow 183
 fuse 60
 fuse box 60, 203
 fuselage 210

G

gable 300
 Gabon 317
 Galápagos Islands 315
 galaxy 280
 gale 286
 galley 214
 gallon 311
 gallop 243
 galvanized 79
 Gambia 317
 game 119, 230, 273
 game show 178
 games 272
 gangway 214
 garage 58, 199, 203
 garbage can 61, 67
 garbanzos 131
 garden 84
 garden center 115
 garden features 84
 garden pea 122
 garden plants 86
 garden styles 84
 garden tools 88
 gardener 188
 gardening 90
 gardening gloves 89
 gardens 261
 garland 111
 garlic 125, 132

garlic press 68
 garnet 288
 garter 35
 garter belt 35
 gas burner 61
 gas pump 199
 gas station 199
 gas tank 203
 gasket 61
 gasoline 199
 gate 85, 182, 247
 gate number 213
 gauze 47, 167
 gear lever 207
 gearbox 202, 204
 gears 206
 gearshift 201
 gel 38, 109
 gems 288
 generation 23
 generator 60
 genitals 12
 geography 162
 geometry 165
 Georgia 318
 gerbera 110
 Germany 316
 get a job v 26
 get married v 26
 get up v 71
 geyser 285
 Ghana 317
 giant slalom 247
 gift shop 114
 gill 294
 gin 145
 gin and tonic 151
 ginger 125, 133
 giraffe 291
 girder 186
 girl 23
 girlfriend 24
 girth 242
 glacier 284
 gladiolus 110
 gland 19
 glass 69, 152
 glass bottle 166
 glass stirrer 167
 glasses 51, 150
 glassware 64
 glaze v 139
 glider 211, 248
 gliding 248
 gloss 83, 271
 glove 224, 233, 236, 246
 gloves 36
 glue 275
 glue gun 78
 gneiss 288
 go to bed v 71
 go to sleep v 71
 goal 221, 223, 224

goal area 223
 goal line 220, 223, 224
 goalkeeper 222, 224
 goalpost 220, 222
 goat 185
 goat's cheese 142
 goat's milk 136
 goggles 238, 247
 going out 75
 gold 235, 289
 goldfish 294
 golf 232
 golf bag 233
 golf ball 233
 golf cart 232, 233
 golf clubs 233
 golf course 232
 golf shoe 233
 golfer 232
 gong 257
 good 321
 good afternoon 322
 good evening 322
 good morning 322
 good night 322
 goodbye 322
 goose 119, 293
 goose egg 137
 gooseberry 127
 gorge 284
 gorilla 291
 gothic 301
 grade 163
 graduate 169
 graduate v 26
 graduation ceremony 169
 graft v 91
 grains 130
 gram 310
 grandchildren 23
 granddaughter 22
 grandfather 22
 grandmother 22
 grandparents 23
 grandson 22
 granite 288
 grape juice 144
 grapefruit 126
 grapeseed oil 134
 graphite 289
 grass 86, 262
 grass bag 88
 grasshopper 295
 grassland 285
 grate v 67
 grated cheese 136
 grater 68
 gratin dish 69
 gravel 88
 gravity 280
 gray 39, 274
 graze 46
 greasy 39

Greece 316
 green 129, 232, 274
 green olive 143
 green onion 125
 green peas 131
 green salad 158
 green tea 149
 greenhouse 85
 Greenland 314
 Grenada 314
 grill pan 69
 grilled 159
 grip 78
 groceries 106
 grocery store 114
 groin 12
 groom 243
 ground 60, 132
 ground coffee 144
 ground cover 87
 ground floor 104
 ground meat 119
 ground sheet 267
 groundnut oil 135
 group therapy 55
 grout 83
 guard 236
 guard rail 195, 246
 Guatemala 314
 guava 128
 guest 64, 100
 guidebook 260
 guided tour 260
 guilty 181
 Guinea 317
 Guinea-Bissau 317
 guitarist 258
 gull 292
 gum 50
 gumdrop 113
 gun 94
 gutter 58, 299
 guy rope 266
 Guyana 315
 gym 101, 250
 gym machine 250
 gymnast 235
 gymnastics 235
 gynecologist 52
 gynecology 49
 gypsophila 110

H

hacksaw 81
 haddock 120
 hail 286
 hair 14, 38
 hair dye 40
 hairband 38
 hairdresser 38, 115, 188
 hair-dryer 38
 hairpin 38
 hairspray 38
 Haiti 314

- half an hour 304
 half-board 101
 half-time 223
 half-liter 311
 halibut fillets 120
 Halloween 27
 hallway 59
 halter 243
 halter neck 35
 ham 119, 143, 156
 hammer 80
 hammer v 79
 hammock 266
 hamper 263
 hamster 290
 hamstring 16
 hand 13, 15
 hand drill 81
 hand fork 89
 hand rail 59
 hand saw 89
 hand towel 73
 handbag 37
 handcuffs 94
 handicap 233
 handkerchief 36
 handle 36, 88, 106, 187, 200, 230
 handlebar 207
 handles 37
 handrail 196
 handsaw 80
 handset 99
 hang v 82
 hang-glider 248
 hang-gliding 248
 hanging basket 84
 hanging file 173
 happy 25
 harbor 217
 harbor master 217
 hard 129, 321
 hard candy 113
 hard cheese 136
 hard hat 186
 hard shoulder 194
 hardboard 79
 hardware 176
 hardware store 114
 hardwood 79
 haricot beans 131
 harness race 243
 harp 256
 harvest v 91, 183
 hat 36
 hatchback 199
 have a baby v 26
 Hawaii 314
 hay 184
 hayfever 44
 hazard 195
 hazard lights 201
 hazelnut 129
 hazelnut oil 134
 head 12, 19, 81, 230
 head v 222
 head injury 46
 headache 44
 headboard 70
 headlight 198, 205
 headphones 268
 headquarters 175
 headrest 200
 headsail 240
 health 44
 health food store 115
 heart 18, 119, 122, 273
 heart attack 44
 heater 60
 heater controls 201
 heather 297
 heating element 61
 heavy 321
 heavy metal 259
 hedge 85, 90, 182
 hedgehog 290
 heel 13, 15, 37
 height 165
 helicopter 211
 hello 322
 helmet 95, 204, 206, 220, 224, 228
 helpdesk 168
 hem 34
 hematite 289
 hemorrhage 46
 hen's egg 137
 herb 55, 86
 herb garden 84
 herbaceous border 85
 herbal remedies 108
 herbal tea 149
 herbalism 55
 herbicide 183
 herbs 133, 134
 herbs and spices 132
 herd 183
 hexagon 164
 high 321
 high chair 75
 high-definition 269
 high dive 239
 high-heeled shoe 37
 high jump 235
 high speed train 208
 highlights 39
 hiking 263
 hill 284
 Himalayas 313
 hip 12
 hippopotamus 291
 historic building 261
 history 162
 hit v 224
 hockey 224
 hockey stick 224
 hoe 88
 hold 215, 237
 hole 232
 hole in one 233
 hole punch 173
 holly 296
 home 58
 home delivery 154
 home entertainment 268
 home furnishings 105
 home plate 228
 homeopathy 55
 homework 163
 homogenized 137
 Honduras 314
 honeycomb 135
 honeymoon 26
 honeysuckle 297
 hood 31, 75, 198
 hoof 242, 291
 hook 187, 276
 hoop 226, 277
 horizontal bar 235
 hormone 20
 horn 201, 204, 291
 horror movie 255
 horse 185, 235, 242
 horse race 243
 horseback riding 242, 263
 horseradish 125
 horseshoe 242
 hose 89, 95
 hose reel 89
 hospital 48
 host 64
 hostess 64
 hot 124, 286, 321
 hot chocolate 144, 156
 hot dog 155
 hot-dog vendor 154
 hot drinks 144
 hot faucet 72
 hot-air balloon 211
 hotel 100, 264
 hot-water bottle 70
 hour 304
 hour hand 304
 house 58
 household products 107
 hovercraft 215
 hub 206
 hubcap 202
 hull 214, 240
 human resources 175
 hiking 263
 humerus 17
 humid 286
 hummingbird 292
 hump 291
 hundred 308
 hundred and ten 308
 hundred thousand 308
 hundredth 309
 Hungary 316
 hungry 64
 hurdles 235
 hurricane 287
 husband 22
 husk 130
 hydrant 95
 hydrofoil 215
 hydrotherapy 55
 hypnotherapy 55
 hypoallergenic 41
 hypotenuse 164
- I**
 ice 120, 287
 ice and lemon 151
 ice bucket 150
 ice climbing 247
 ice cream 149
 ice cube 151
 ice hockey 224
 ice hockey player 224
 ice hockey rink 224
 ice maker 67
 ice cream 137
 iced coffee 148
 iced tea 149
 ice-skate 224
 ice-skating 247
 Iceland 316
 icicle 287
 icing 141
 icon 177
 identity tag 53
 igneous 288
 ignition 200
 iguana 293
 illness 44
 immigration 212
 impotent 20
 in 320
 in brine 143
 in front of 320
 in oil 143
 in sauce 159
 in syrup 159
 inbox 177
 inch 310
 incisor 50
 incubator 53
 index finger 15
 India 318
 Indian Ocean 312
 indigo 274
 Indonesia 319
 induce labor v 53
 industrial park 299
 infection 44
 infertile 20
 infield 228
 inflatable dinghy 215
 information 261
 information screen 213
 in-goal area 221
 inhaler 44, 109
 injection 48
 injury 46
 ink 275
 ink pad 173
 inlet 61
 inline skating 249
 inner core 282
 inner tube 207
 inning 228
 innocent 181
 inoculation 45
 insect repellent 108, 267
 inside 320
 insomnia 71
 inspector 94
 install v 177
 instant camera 270
 instep 15
 instructions 109
 instruments 256, 258
 insulating tape 81
 insulation 61
 insulin 109
 insurance 203
 intensive care unit 48
 interchange 194
 intercom 59
 intercostal 16
 intercourse 20
 interest rate 96
 interior 200
 internal systems 60
 international flight 212
 internet 177
 intersection 298
 interval 254
 interviewer 179
 into 320
 in-tray 172
 invertebrates 295
 investigation 94
 investment 97
 ionosphere 286
 iPod 268
 iPad 176
 Iran 318
 Iraq 318
 Ireland 316
 iris 51, 110
 iron 76, 109, 233, 289
 iron v 76
 ironing board 76
 island 282
 Israel 318
 Italy 316
 itinerary 260
 IUD 21
 Ivory Coast 317
- J**
 jack 203, 273
 jacket 32, 34
 jackhammer 187
 jade 288
 jam 134, 156
 Jamaica 314

- jar 134, 311
javelin 234
jaw 14, 17
jazz 259
jeans 31, 33
jelly bean 113
jellyfish 295
Jerusalem artichoke 125
jet 288
jet-skiing 241
jetty 217
jeweler 188
jewelry store 114
jewelry 36
jewelry box 36
jewelry-making 275
jigsaw 78
jigsaw puzzle 273
jodhpurs 242
jog in place 251
jogging 251, 263
jogging suit 31, 32
joint 17, 119
joker 273
Jordan 318
journal 168
journalist 190
judge 180
judo 236
jug 65
juices and milkshakes 149
juicy 127
July 306
jumbo shrimp 121
jump 237, 243
jump v 227
jump ball 226
jumping rope 251
June 306
Jupiter 280
jury 180
jury box 180
- K**
kale 123
kangaroo 291
karate 236
Karlíngrad 316
kayak 241
Kazakhstan 318
kebab 155, 158
keel 214
keep net 244
kendo 236
Kenya 317
kernel 122, 129, 130
ketchup 135, 154
kettle 66
kettledrum 257
key 59, 80, 176, 207
keyboard 176, 258
keypad 97, 99
kick 237, 239
- kick v 221, 223
kickboxing 236
kickstand 207
kid 185
kidney 18, 119
kilogram 310
kilometer 310
king 272, 273
kippers 157
kitchen 66, 152
kitchen knife 68
kitchenware 68, 105
kitten 290
kiwifruit 128
knead v 138
knee 12
knee pad 205
knee support 227
kneecap 17
knee-length 34
knife 65, 80
knife sharpener 68, 118
knight 272
knitting 277
knitting needle 277
knock out 237
knuckle 15
koala 291
kohlrabi 123
koi carp 294
kumquat 126
kung fu 236
Kuwait 318
Kyrgyzstan 318
- L**
labels 89
labia 20
laboratory 166
lace 35, 37
lace bobbin 277
lace-making 277
lace-up 37
lacrosse 249
lactose 137
ladder 95, 186
ladle 68
lady fingers 141
ladybug 295
lake 285
lamb 118, 185
lamp 62, 207, 217
land 282
land v 211
landing 59
landing gear 210
landing net 244
landlord 58
landscape 271, 284
landscape v 91
lane 234, 238
languages 162
Laos 318
lapel 32
- laptop 175
larch 296
large 321
large intestine 18
larynx 19
last week 307
lat 16
late 305
later 304
latex paint 83
latitude 283
Latvia 316
laugh v 25
launch 281
launch pad 281
laundromat 115
laundry 76
laundry basket 76
laundry service 101
lava 283
law 169, 180
lawn 85, 90
lawn rake 88
lawnmower 88, 90
lawyer 180, 190
lawyer's office 180
laxative 109
lead singer 258
leaded 199
leaf 122, 296
league 223
lean meat 118
learn v 163
leather shoes 32
leathers 205
Lebanon 318
lecture hall 169
leek 125
left 260
left field 228
left-hand drive 201
leg 12, 119
leg pad 225
leg press 251
legal advice 180
legal department 175
leggings 31
legumes 130
leisure 258, 254, 264
lemon 126
lemon curd 134
lemon grass 133
lemon sole 120
lemonade 144
length 165, 310
lens 270
lens (eye) 51
lens (glasses) 51
lens cap 270
lens case 51
Lesotho 317
lesson 163
let! 231
letter 98
- letter slot 58, 99
letterhead 173
lettuce 123
level 80, 187
lever 61, 150
Liberia 317
librarian 168, 190
library 168, 299
library card 168
Libya 317
license plate 198
liquor store 115
licorice 113
lid 61, 66
Liechtenstein 316
life events 26
life jacket 240
life preserver 240
life raft 240
lifeboat 214
lifeguard 239, 265
lifeguard tower 265
ligament 17
light 178, 321
light a fire v 266
light aircraft 211
light bulb 60
lighter 112
lighthouse 217
lighting 105
lightmeter 270
lightning 287
lights 94
lights switch 201
lily 110
lime 126, 296
limestone 288
limousine 199
line 244
line judge 220
line of play 233
linen 105, 277
linen basket 76
lines 165
linesman 223, 230
lingerie 35, 105
lining 32
lining paper 83
link 36
lintel 186
lion 291
lip 14
lip brush 40
lip gloss 40
lip liner 40
lipstick 40
liqueur 145
liquid 77
liquid dispenser 311
liquid measure 311
liter 311
literature 162, 169
Lithuania 316
little finger 15
- little toe 15
live 60, 178
live rail 209
liver 18, 118
livestock 183, 185
living room 62
lizard 293
load v 76
load line 214
loaf 139
loan 96, 168
lob 230
lobby 100, 255
lobster 121, 295
lock 59, 207
lockers 239
log on v 177
loganberry 127
logo 31
loin 121
lollipop 113
long 32
long jump 235
long wave 179
long-grain 130
long-handled shears 88
longitude 283
loofah 73
loom 277
loose tea 144
lose v 273
loser 273
lotion 109
lottery tickets 112
love 230
low 321
luge 247
luggage 100, 198, 213
luggage department 104
luggage hold 196
luggage rack 209
lumbar vertebrae 17
lunar module 281
lunch 64
lunch menu 152
lung 18
lunges 251
lining 32
lining paper 83
link 36
lintel 186
lion 291
lip 14
lip brush 40
lip gloss 40
lip liner 40
lipstick 40
liqueur 145
liquid 77
liquid dispenser 311
liquid measure 311
liter 311
literature 162, 169
Lithuania 316
little finger 15
- M**
macadamia 129
mace 132
Macedonia 316
machine gun 189
machinery 187
mackerel 120
macramé 277
Madagascar 317
magazine 112

- magazines 107
 magma 283
 magnesium 109
 magnet 167
 maid service 101
 mail carrier 98, 190
 mailbag 98, 190
 mailbox 99
 mainsail 240
 make a will *v* 26
 make friends *v* 26
 make the bed *v* 71
 makeup 40
 making bread 138
 malachite 288
 Malawi 317
 Malaysia 318
 Maldives 318
 male 12, 21
 Mali 317
 mallet 78, 275
 malt vinegar 135
 Malta 316
 malted drink 144
 mammals 290
 man 23
 manager 24, 174
 manchego 142
 mane 242, 291
 mango 128
 mangosteen 128
 manhole 299
 manicure 41
 mantle 282
 manual 200
 map 261
 maple 296
 maple syrup 134
 maracas 257
 marathon 234
 marble 288
 March 306
 margarine 137
 marina 217
 marinated 143, 159
 marine fishing 245
 marjoram 133
 mark *v* 227
 market 115
 marketing department 175
 marmalade 134, 156
 marrow 124
 Mars 280
 marshmallow 113
 martial arts 237
 martini 151
 marzipan 141
 mascara 40
 mashed 159
 masher 68
 mask 189, 228, 236, 239, 249
 masking tape 83
 masonry bit 80
 massage 54
 mast 240
 masters 169
 mat 54, 83, 235, 271
 match 230
 material 276
 materials 79, 187
 maternity 49
 maternity ward 48
 math 162, 164
 mattress 70, 74
 Mauritania 317
 Mauritius 317
 May 306
 maybe 322
 mayonnaise 135
 MDF 79
 meadow 285
 meal 64
 measles 44
 measure 150, 151
 measure *v* 310
 measurements 165
 measuring cup 69, 311
 measuring spoon 109
 meat 119
 meat and poultry 106
 meat tenderizer 68
 meatballs 158
 meathook 118
 mechanic 188, 203
 mechanics 202
 medals 235
 media 178
 medical examination 45
 medication 109
 medicine 109, 169
 medicine cabinet 72
 meditation 54
 Mediterranean Sea 313
 medium wave 179
 meeting 174
 meeting room 174
 melody 259
 melon 127
 memory 176
 memory stick 176
 men's clothing 32
 menswear 105
 menstruation 20
 menu 148, 153, 154
 menu bar 177
 mercury 289
 Mercury 280
 meringue 140
 mesosphere 286
 messages 100
 metacarpal 17
 metal 79
 metal bit 80
 metals 289
 metamorphic 288
 metatarsal 17
 meteor 280
 meter 310
 Mexico 314
 mica 289
 microphone 179, 258
 microscope 167
 microwave oven 66
 midday 305
 middle finger 15
 midnight
 midwife 53
 migraine 44
 mile 310
 milk 136, 156
 milk *v* 183
 milk carton 136
 milk chocolate 113
 milkshake 137
 millennium 307
 millet 130
 milligram 310
 milliliter 311
 millimeter 310
 mineral 144
 mineral spirits 83
 minerals 289
 mini bar 101
 minibus 197
 minivan 199
 mini-dress 34
 mint 113, 133
 mint tea 149
 minus 165
 minute 304
 minute hand 304
 minutes 174
 mirror 40, 71, 167
 miscarriage 52
 Miss 23
 missile 211
 mist 287
 miter block 81
 mitt 228
 mittens 30
 mix *v* 67, 138
 mixing bowl 66, 69
 mixing desk 179
 moat 300
 mobile 74
 model 169, 190
 model-making 275
 modeling tool 275
 moisturizer 41
 molar 50
 Moldova 316
 mole 14
 Monaco 316
 Monday 306
 money 97
 money order 98
 Mongolia 318
 monitor 172
 monitor 53
 monkey 291
 monkfish 120
 monopoly 272
 monorail 208
 monsoon 287
 month 306
 monthly 307
 monument 261
 Moon 280
 moonstone 288
 moor *v* 217
 mooring 217
 mop 77
 morning 305
 Morocco 317
 mortar 68, 167, 187
 mortgage 96
 mosque 300
 mosquito 295
 mosquito net 267
 moth 295
 mother 22
 mother-in-law 23
 motocross 249
 motor 88
 motor racing 249
 motorcycle 204
 motorcycle racing 249
 molding 63
 motor 88
 mountain 284
 mountain bike 206
 mountain range 282
 mouse 176, 290
 mousse 141
 mouth 14
 mouth guard 237
 mouthwash 72
 move 273
 movie 260, 271
 movie set 179
 movie theater 255, 299
 mow *v* 90
 Mozambique 317
 mozzarella 142
 Mr. 23
 Mrs. 23
 mudguard 205
 muffin 140
 muffin pan 69
 muffler 203, 204
 mug 65
 mulch *v* 91
 multigrain bread 139
 multiply *v* 165
 multivitamin tablets 109
 mumps 44
 mung beans 131
 muscles 16
 museum 261
 mushroom 125
 music 162
 music school 169
 musical 255
 musical score 255
 musical styles 259
 musician 191
 mussel 121, 295
 mustard 155
 mustard seed 131
 Myanmar 318

N

- naan bread 139
 nail 15, 80
 nail clippers 41
 nail file 41
 nail polish 41
 nail polish remover 41
 nail scissors 41
 Namibia 317
 nape 13
 napkin 65
 napkin ring 65
 narrow 321
 nation 315
 national park 261
 natural 256
 natural fiber 31
 naturopathy 55
 nausea 44
 navel 12
 navigate *v* 240
 near 320
 nearsightedness 51
 nebula 280
 neck 12, 258
 neck brace 46
 necklace 36
 nectarine 126
 needle 109, 276
 needle plate 276
 needlenose pliers 80
 needlepoint 277
 negative 271
 negative electrode 167
 neighbor 24
 neoclassical 301
 Nepal 318
 nephew 23
 Neptune 280
 nerve 19, 50
 nervous 19, 25
 net 217, 222, 226, 227, 231
 net *v* 245
 net curtain 63
 Netherlands 316
 nettle 297
 network 176
 neurology 49
 neutral 60

- neutral zone 224
 new 321
 new moon 280
 new potato 124
 New Year 27
 New Zealand 319
 newborn baby 53
 news 178
 newscaster 179, 191
 newspaper 112
 newsstand 112
 next week 306
 nib 163
 Nicaragua 314
 nickel 289
 niece 23
 Niger 317
 Nigeria 317
 night 305
 nightgown 35
 nightie 31
 nightwear 31
 nightstand 70
 nightstick 94
 nine 308
 nine hundred 308
 nineteen 308
 nineteen hundred 307
 nineteen hundred and one 307
 nineteen ten 307
 nineteenth 309
 ninetieth 309
 ninety 308
 ninth 309
 nipple 12
 no 322
 no entry 195
 no right turn 195
 no stopping 195
 nonstick 69
 noodles 158
 normal 39
 north 312
 North and Central America 314
 North Korea 318
 North Pole 283
 North Sea 312
 Northern Hemisphere 283
 Norway 316
 nose 14, 210
 nose clip 238
 noseband 242
 nosebleed 44
 nosewheel 210
 nostril 14
 notation 256
 note 97, 256
 notecard 173
 notepad 173
 notebook 163, 172
 notes 191
 notice board 173
 notions 105
 nougat 113
 November 306
 now 304
 nozzle 89
 number 226
 numbers 308
 numerator 165
 nurse 45, 48, 52, 189
 nursery 74
 nursing 53
 nursing bra 53
 nut 80
 nutmeg 132
 nuts 151
 nuts and dried fruit 129
 nylon 277
- O**
 oak 296
 oar 241
 oatmeal 156
 oats 130
 objective lens 167
 oboe 257
 obsidian 288
 obstetrician 52
 occupations 188, 190
 occupied 321
 ocean 282
 ocean liner 215
 octagon 164
 October 306
 octopus 121, 295
 odometer 201
 offal 118
 offers 106
 office 24, 172, 174
 office building 298
 office equipment 172
 office supplies 173
 off-piste 247
 off-side 223
 oil 142, 199
 oil paints 274
 oil tank 204
 oil tanker 215
 oils 134
 oily 41
 ointment 47, 109
 okra 122
 old 321
 olive oil 134
 olives 151
 Oman 318
 omelet 158
 on time 305
 on top of 320
 oncology 49
 one 308
 one billion 309
 one million 309
 one thousand 309
- one-way 194
 one-way system 298
 onion 124
 on-line 177
 onto 320
 onyx 289
 opal 288
 open 260, 321
 open sandwich 155
 open-top 260
 opera 255
 operating room 48
 operation 48
 operator 99
 ophthalmology 49
 opponent 236
 opposite 320
 optic 150
 optic nerve 51
 optician 51, 189
 orange 126, 274
 orange juice 148
 orangeade 144
 orbit 280
 orchestra 254, 256
 orchestra pit 254
 orchid 111
 order v 153
 oregano 133
 organic 91, 118, 122
 organic waste 61
 organizer 175
 origami 275
 ornamental 87
 orthopedics 49
 osteopathy 54
 ostrich 292
 otter 290
 ounce 310
 out 225, 228, 320
 out of bounds 226
 out of focus 271
 outboard motor 215
 outbuilding 182
 outdoor activities 262
 outer core 282
 outfield 229
 outlet 61
 outpatient 48
 outside 320
 out-tray 172
 oval 164
 ovary 20
 oven 66
 oven mitt 69
 ovenproof 69
 over 320
 over par 233
 overalls 30, 82
 overdraft 96
 overexposed 271
 overflow pipe 61
 overhead bin 210
 overhead projector 163
- overpass 194
 overture 256
 ovulation 20, 52
 owl 292
 oyster 121
 ozone layer 286
- P**
 Pacific Ocean 312
 pack 311
 pack of cigarettes 112
 package 99, 311
 pad 224
 paddle 241
 paddock 242
 pads 53, 220
 painkiller 109
 painkillers 47
 pail 77, 82, 265
 paint 83
 paint v 83
 paint can 83
 paint tray 83
 painter 191
 painting 62, 261, 274
 paints 274
 pajamas 33
 pak-choi 123
 Pakistan 318
 palate 19
 palette 274
 pallet 186
 palm 15, 86, 296
 palm hearts 122
 pan 310
 pan-fried 159
 Panama 314
 pancreas 18
 panda 291
 panties 35
 pants 32, 34
 panty liner 108
 papaya 128
 paper clip 173
 paper napkin 154
 paper tray 172
 papier-maché 275
 paprika 132
 Papua New Guinea 319
 par 233
 parachute 248
 parachuting 248
 paragliding 248
 Paraguay 315
 parallel 165
 parallel bars 235
 parallelogram 164
 paramedic 94
 parents 23
 park 262
 park v 195
 parka 31, 33
 parking brake 203
 parking meter 195
- parking lot 298
 parmesan 142
 parole 181
 parrot 293
 parsley 133
 parsnip 125
 partner 23
 pass 226
 pass v 195, 220, 223
 passcode 99
 passenger 216
 passenger port 216
 passion fruit 128
 Passover 27
 passport 213
 passport control 213
 pasta 158
 pastels 274
 pasteurized 137
 pasting brush 82
 pasting table 82
 pastry 140, 149
 pastry brush 69
 pasture 182
 patch 207
 patchwork 277
 pâté 142, 156
 path 58, 85
 pathology 49
 patient 45
 patio garden 85
 pattern 276
 pause 269
 paving 85
 pawn 272
 pay v 153
 pay-per-view channel 269
 payphone 99
 payment 96
 payroll 175
 peach 126, 128
 peacock 293
 peanut 129
 peanut butter 135
 peanuts 151
 pear 127
 peas 131
 pecan 129
 pectoral 16
 pectoral fin 294
 pedal 61, 206
 pedal v 207
 pedestrian zone 299
 pediatrics 49
 pedicure 41
 pediment 301
 peel v 67
 peeled shrimp 120
 pelican 292
 pelvis 17
 pen 163, 185
 pen holder 172
 pen pal 24

- penalty 222
 penalty area 223
 pencil 163, 275
 pencil case 163
 pencil sharpener 163
 pendant 36
 penguin 292
 peninsula 282
 penis 21
 pentagon 164
 peony 111
 people 12, 16
 pepper 64, 124, 152
 peppercorn 132
 pepperoni 142
 percentage 165
 percussion 257
 perennial 86
 perfume 41, 105
 pergola 84
 periodical 168
 perm 39
 perpendicular 165
 persimmon 128
 personal best 234
 personal organizer 173, 175
 personal trainer 250
 Peru 315
 pesticide 89, 183
 pestle 68, 167
 pet food 107
 pet store 115
 petal 297
 petri dish 166
 pharmacist 108, 189
 pharmacy 108
 pharynx 19
 pheasant 119, 293
 Phillips screwdriver 81
 philosophy 169
 Philippines 319
 photo album 271
 photo finish 234
 photographer 191
 photograph 271
 photograph v 271
 photography 270
 phyllo pastry 140
 physical education 162
 physics 162, 169
 physiotherapy 49
 piano 256
 piccolo 257
 pick v 91
 pick-and-mix 113
 pickax 187
 pickled 159
 pickup 258
 picnic 263
 picnic bench 266
 picture frame 271
 pie 158
 pie pan 69
 piece 272
 pier 217
 pies 143
 pig 185
 pig farm 183
 pigeon 292
 pigeonhole 100
 piglet 185
 pigsty 185
 pigtailed 39
 Pilates 251
 pill 21, 109
 pillar 300
 pillion 204
 pillow 70
 pillowcase 71
 pilot 190, 211
 pin 60, 237, 249, 276
 PIN 96
 pincushion 276
 pine 296
 pine nut 129
 pineapple 128
 pineapple juice 149
 pink 274
 pint 311
 pinto beans 131
 pipe 112, 202
 pipe cutter 81
 pipette 167
 piping bag 69
 pistachio 129
 pita bread 139
 pitch v 229
 pitch a tent v 266
 pitcher 151, 229
 pitcher's mound 228
 pitches available 266
 pith 126
 pizza 154
 pizzeria 154
 place mat 64
 place setting 65
 placenta 52
 plain 285
 plane 81
 plane v 79
 planet 280, 282
 plant v 183
 plant pot 89
 plants 86, 296
 plaque 50
 plaster v 82
 plastic bag 122
 plastic pants 30
 plastic surgery 49
 plate 283
 plateau 284
 platform 208
 platform number 208
 platinum 289
 play 254, 269
 play v 229, 273
 player 221, 231, 273
 playground 263
 playhouse 75
 playing 75
 playpen 75
 plea 180
 please 322
 plow v 183
 plug 60, 72
 plum 126
 plumb line 82
 plumber 188
 plumbing 61
 plunger 81
 plus 165
 Pluto 280
 plywood 79
 poach v 67
 poached 159
 pocket 32
 pod 122
 podium 235, 256
 point 273
 poisoning 46
 poker 273
 Poland 316
 polar bear 291
 Polaroid camera 270
 pole 245, 282
 pole vault 234
 police 94
 police car 94
 police officer 94, 189
 police station 94
 polish 77
 polish v 77
 politics 169
 polo 243
 polyester 277
 pomegranate 128
 pommel 242
 pommel horse 235
 pond 85
 ponytail 39
 pool 249
 pop 259
 popcorn 255
 poplar 296
 popper 30
 poppy 297
 poppy seeds 138
 porch 58
 porch light 58
 pore 15
 pork 118
 port 145, 176, 214, 216
 porter 100
 portfolio 97
 porthole 214
 portion 64
 portrait 271
 Portugal 316
 positive electrode 167
 post office 98
 postage 98
 postal worker 98
 postcard 112
 poster 255
 poster paint 274
 postgraduate 169
 postmark 98
 pot v 91
 potato 124
 potpourri 111
 potted plant 87, 110
 potter's wheel 275
 pottery 275
 potty 74
 pouch 291
 poultry 119
 poultry farm 183
 pound 310
 pour v 67
 powder 77, 109
 powder puff 40
 powdered milk 137
 power 60
 power cord 176
 power outage 60
 practice swing 233
 pram 75
 praying mantis 295
 pregnancy 52
 pregnancy test 52
 pregnant 52
 premature 52
 premolar 50
 prenatal 52
 prerecorded 178
 prescription 45
 present 27
 presentation 174
 presenter 178
 preservative 83
 preserved fruit 134
 press 178
 presser foot 276
 pressure valve 61
 price 152, 199
 price list 154
 prickly pear 128
 primer 83
 primrose 297
 principal 163
 principality 315
 print 271
 print v 172
 printer 172, 176
 printing 275
 prison 181
 prison guard 181
 private bathroom 100
 private jet 211
 private room 48
 probe 50
 problems 271
 processed grains 130
 procession 27
 processor 176
 produce stand 114, 188
 producer 254
 professor 169
 program 176
 program 254, 269
 programming 178
 propagate v 91
 propeller 211, 214
 proposal 174
 prosciutto 143
 prosecution 180
 prostate 21
 protractor 165
 proud 25
 prove v 139
 province 315
 prow 215
 prune 129
 prune v 91
 pruners 89
 psychiatry 49
 psychotherapy 55
 public address system 209
 puck 224
 pudding rice 130
 Puerto Rico 314
 puff pastry 140
 pull up v 251
 pulp 127
 pulse 47
 pumice 288
 pumice stone 73
 pump 37, 207
 pumpkin 125
 pumpkin seed 131
 punch 237
 punching bag 237
 pup 290
 pupil 51, 162
 puppy 290
 purple 274
 pushup 251
 purse 37
 putt v 233
 putter 233
 pyramid 164

Q

- Qatar 318
 quadriceps 16
 quail 119
 quail egg 137
 quart 311
 quarter of an hour 304
 quarterdeck 214
 quartz 289
 queen 272, 273
 question 163
 question v 163
 quiche pan 69

quilt 71
 quilting 277
 quince 128
 quinoa 130
 quiver 249

R

rabbit 118, 290
 raccoon 290
 race 234
 race-car driver 249
 racecourse 243
 racehorse 243
 racing bike 205, 206
 racing dive 239
 rack 166
 racket 230
 racket games 231
 racquetball 231
 radar 214, 281
 radiator 60, 202
 radicchio 123
 radio 179, 268
 radio antenna 214
 radio station 179
 radiology 49
 radish 124
 radius 17, 164
 rafter 186
 rafting 241
 rail 208
 rail network 209
 rain 287
 rain gear 245, 267
 rainbow 287
 rainbow trout 120
 raincoat 31, 32
 rainforest 285
 raisin 129
 rake 88
 rake v 90
 rally 230
 rally driving 249
 RAM 176
 Ramadan 26
 ramekin 69
 range 67
 rap 259
 rapeseed 184
 rapids 240, 284
 rappeling 248
 rash 44
 raspberry 127
 raspberry jam 134
 rat 290
 rattle 74
 raw 124, 129
 ray 294
 razor blade 73
 razorshell clam 121
 read v 162
 reading light 210
 reading list 168
 reading room 168

reamer 80
 rear light 207
 rear wheel 197
 rearview mirror 198
 receipt 152
 receive v 177
 receiver 99
 reception 100
 receptionist 100, 190
 record 234, 269
 record player 268
 record store 115
 recording studio 179
 rectangle 164
 rectum 21
 recycling bin 61
 red 145, 274
 red card 223
 red-eye 271
 red kidney beans 131
 red lentils 131
 red meat 118
 red mullet 120
 Red Sea 313
 reduce v 172
 reduced-fat milk 136
 reel 244
 reel in v 245
 referee 222, 226
 referral 49
 reflector 50, 204, 207
 reflector strap 205
 reflexology 54
 refrigerator 67
 reggae 259
 region 315
 register 100
 registered mail 98
 regulator 239
 reheat v 154
 reiki 55
 reins 242
 relationships 24
 relatives 23
 relaxation 55
 relay race 235
 release v 245
 remote control 269
 Renaissance 301
 renew v 168
 rent 58
 rent v 58
 repair kit 207
 reporter 179
 reproduction 20
 reproductive 19
 reproductive organs 20
 reptiles 293
 research 169
 reserve v 168
 residence hall 168
 respiratory 19
 rest 256

restaurant 101, 152
 result 49
 resurfacing 187
 resuscitation 47
 retina 51
 retire v 26
 return 231
 return address 98
 return date 168
 rewind 269
 rhinoceros 291
 rhombus 164
 rhubarb 127
 rhythmic gymnastics 235
 rib 17, 119
 rib cage 17
 ribbon 27
 ribbon 39, 111, 141, 235
 ribs 155
 rice 130, 158, 184
 rice pudding 140
 rider 242
 riding boot 242
 riding crop 242
 riding hat 242
 rigging 215, 240
 right 260
 right field 229
 right-hand drive 201
 rim 206
 rind 119, 127, 136, 142
 ring 36
 ring binder 173
 ring finger 15
 ring ties 89
 rings 235
 rinse v 38, 76
 ripe 129
 rise v 139
 river 284
 road bike 206
 road markings 194
 road signs 195
 roads 194
 road work 187, 195
 roast 158
 roast v 67
 roasted 129
 roasting pan 69
 robe 35, 38, 169
 rock climbing 248
 rock concert 258
 rock garden 84
 rocket 123
 rocks 284, 288
 Rocky Mountains 312
 rococo 301
 rodeo 243
 roll 139, 311
 roll v 67
 roller 83, 187
 roller coaster 262
 roller shade 63
 rollerblading 263

rolling pin 69
 romance 255
 Romania 316
 romper 30
 roof 58, 203
 roof garden 84
 roof tile 187
 roof rack 198
 rook 272
 room 58
 room key 100
 room number 100
 room service 101
 rooms 100
 rooster 185
 root 50, 124, 296
 rope 248
 rose 89, 110, 145
 rosé 145
 rosemary 133
 rotor blade 211
 rotten 127
 rough 232
 round 237
 round neck 33
 roundabout 195
 route number 196
 router 78
 row 210, 254
 row v 241
 rower 241
 rowboat 214
 rowing machine 250
 rubber band 173
 rubber boots 89
 rubber ring 265
 rubber stamp 173
 rub v 288
 ruck 221
 rudder 210, 241
 rug 63
 rugby 221
 ruler 163, 165
 rum 145
 rum and coke 151
 rump steak 119
 run 228
 run v 228
 running shoe 37
 runway 212
 rush 86
 rush hour 209
 Russian Federation 318
 rutabaga 125
 Rwanda 317
 rye bread 138

S

sad 25
 saddle 206, 242
 safari park 262
 safe 228
 safety 75, 240
 safety goggles 81, 167

safety pin 47
 saffron 132
 sage 133
 Sahara Desert 313
 sail 241
 sailboat 215
 sailing 240
 sailor 189
 salad 149
 salamander 294
 salami 142
 salary 175
 sales clerk 104, 188
 sales department 175
 salmon 120
 salt 64, 152
 salted 121, 129, 137, 143
 San Marino 316
 sand 85, 264
 sand v 82
 sandal 37
 sandals 31
 sandbox 263
 sandcastle 265
 sander 78
 sandpaper 81, 83
 sandstone 288
 sandwich 155
 sandwich counter 143
 sanitary napkin 108
 São Tomé and Príncipe 317
 sapphire 288
 sardine 120
 Sardinia 316
 satellite 281
 satellite dish 269
 satellite navigation 201
 satnav 195
 satsuma 126
 Saturday 306
 Saturn 280
 sauce 134, 143, 155
 saucepan 69
 Saudi Arabia 318
 sauna 250
 sausage 155, 157
 sausages 118
 sauté v 67
 save v 177, 223
 savings 96
 savings account 97
 savory 155
 saw v 79
 saxophone 257
 scaffolding 186
 scale 121, 256, 294
 scales 45, 53, 69, 98, 118, 166, 212, 293, 310
 scallop 121
 scalp 39
 scalpel 167

- scan 48, 52
 scanner 106, 176
 scarecrow 184
 scared 25
 scarf 31, 36
 schedule 197, 209, 261
 schist 288
 scholarship 169
 school 162, 299
 school bus 196
 schoolbag 162
 schoolboy 162
 schoolgirl 162
 schools 169
 science 162, 166
 science fiction movie
 255
 scientist 190
 scissors 38, 47, 82, 276
 scoop 68, 149
 scooter 205
 score 220, 256, 273
 score a goal v 223
 scoreboard 225
 scorpion 295
 scotch and water 151
 scrabble 272
 scrambled eggs 157
 scrape v 77
 scraper 82
 screen 59, 97, 176, 255,
 269
 screw 80
 screwdriver 80, 151
 screwdriver bits 80
 script 254
 scrollbar 177
 scrotum 21
 scrub v 77
 scrum 221
 scuba diving 239
 sculpting 275
 sculptor 191
 sea 264, 282
 sea bass 120
 sea bream 120
 sea horse 294
 sea lion 290
 sea plane 211
 seafood 121
 seal 290
 sealant 83
 sealed jar 135
 seam 34
 seamstress 191
 search v 177
 seasonal 129
 seasons 306
 seat 61, 204, 209, 210,
 242, 254
 seat back 210
 seat belt 198, 211
 seat post 206
 seating 254
 second 304, 309
 second floor 104
 second-hand 304
 second-hand store 115
 section 282
 security 212
 security bit 80
 security guard 189
 sedan 199
 sedative 109
 sedimentary 288
 seed 122, 127, 128, 130
 seed tray 89
 seeded bread 139
 seedless 127
 seedling 91
 seeds 88, 131
 seasaw 263
 segment 126
 self-defense 237
 self-rising flour 139
 self-tanning cream 41
 semi-hard cheese 136
 seminal vesicle 21
 semi-soft cheese 136
 semisweet chocolate
 113
 semolina 130
 send v 177
 send off 223
 Senegal 317
 sensitive 41
 sentence 181
 September 306
 series 179
 serve 231
 serve v 64, 231
 server 176
 service included 152
 service line 230
 service not included 152
 service provider 177
 service vehicle 212
 serving spoon 68
 sesame seed 131
 sesame oil 134
 set 178, 230, 254
 set v 38
 set honey 134
 set sail v 217
 set the alarm v 71
 set the table v 64
 seven 308
 seven hundred 308
 seventeen 308
 seventeenth 309
 seventh 309
 seventieth 309
 seventy 308
 sew v 277
 sewing basket 276
 sewing machine 276
 sexually transmitted
 disease 20
 shade 41
 shade plant 87
 shallot 125
 shallow end 239
 shampoo 38
 shapes 164
 share price 97
 shares 97
 shark 294
 sharp 256
 shaving 73
 shaving foam 73
 shears 89
 shed 84
 sheep 185
 sheep farm 183
 sheep's milk 137
 sheet 71, 74, 241
 shelf 67, 106
 shell 129, 137, 265, 293
 shelled 129
 shelves 66
 sherbet 141
 sherry 145
 shiatsu 54
 shield 88
 shin 12
 ship 214
 ships 215
 shipyard 217
 shirt 33
 shock 47
 shocked 25
 shoe department 104
 shoe store 114
 shoes 34, 37
 shoot v 223, 227
 shop 298
 shopping 104
 shopping bag 106
 shopping center 104
 shops 114
 short 32, 321
 short wave 179
 short-grain 130
 shorts 30, 33
 shot 151
 shotgun 234
 shoulder 13
 shoulder bag 37
 shoulder blade 17
 shoulder pad 35
 shoulder strap 37
 shout v 25
 shovel 187
 shower 72, 286
 shower block 266
 shower curtain 72
 shower door 72
 shower gel 73
 shower head 72
 showjumping 243
 shuffle v 273
 shutoff valve 61
 shutter 58
 shutter release 270
 shuttle bus 197
 shuttlecock 231
 shy 25
 Siberia 313
 Sicily 316
 side 164
 side effects 109
 side mirror 198
 side order 153
 side plate 65
 side-saddle 242
 side street 299
 sidedeck 240
 sideline 220, 226, 230
 sidewalk 298
 sidewalk café 148
 Sierra Leone 317
 sieve 68, 89
 sieve v 91
 sift v 138
 sigh v 25
 sightseeing 260
 sign 104
 signal 209
 signature 96, 98
 silk 277
 silo 183
 silt 85
 silver 235, 289
 simmer v 67
 Singapore 319
 singer 191
 single 151
 single room 100
 singles 230
 sink 38, 60, 61, 66, 72
 sinus 19
 siren 94
 sirloin steak 119
 sister 22
 sister-in-law 23
 site manager's office 266
 situp 251
 six 308
 six hundred 308
 sixteen 308
 sixteenth 309
 sixth 309
 sixtieth 309
 sixty 308
 skate 120, 247, 294
 skate v 224
 skate wings 120
 skateboard 249
 skateboarding 249, 263
 skein 277
 skeleton 17
 sketch 275
 sketch pad 275
 skewer 68
 ski 241, 246
 ski boot 246
 ski jacket 246
 ski jump 247
 ski pole 246
 ski run 246
 ski slope 246
 skier 246
 skiing 246
 skim milk 136
 skin 14, 119, 128
 skin care 108
 skinned 121
 skirt 30, 34
 skull 17
 skydiving 248
 skyscraper 299, 300
 slalom 247
 slate 288
 sledding 247
 sledgehammer 187
 sleeper 30
 sleeping 74
 sleeping bag 267
 sleeping compartment
 209
 sleeping mat 267
 sleeping pill 109
 sleet 286
 sleeve 34
 sleeveless 34
 slice 119, 139, 140, 230
 slice v 67
 sliced bread 138
 slicer 139
 slide 167, 263
 slide v 229
 sling 46
 slip 35
 slip-on 37
 slippers 31
 slope 284
 slotted spatula 68
 slotted spoon 68
 Slovakia 316
 Slovenia 316
 slow 321
 slug 295
 small 321
 small intestine 18
 small of back 13
 smartphone 176
 smash 231
 smile 25
 smoke 95
 smoke alarm 95
 smoked 118, 121, 143,
 159
 smoked fish 143
 smoking 112
 snack bar 113, 148
 snail 295

- snake 293
snare drum 257
sneeze 44
snore *v* 71
snorkel 239
snout 293
snow 287
snowboarding 247
snowmobile 247
snowsuit 30
soak *v* 130
soap 73, 178
soap dish 73
soap 220, 222
soccer field 220
soccer player 220
soccer player 222
soccer uniform 31, 222
socket 60, 80
socket wrench 80
socks 33
soda bread 139
soda water 144
sofa 62
sofabed 63
soft 129, 321
soft cheese 136
soft drink 154
soft drinks 144
soft toy 75
software 176
softwood 79
soil 85
solar system 280
solder 79, 80
solder *v* 79
soldering iron 81
soldier 189
sole 15, 37
solids 164
Solomon Islands 319
soluble 109
solvent 83
Somalia 317
somersault 235
son 22
sonata 256
song 259
son-in-law 22
sorrel 123
sorting unit 61
soufflé 158
soufflé dish 69
sound boom 179
sound technician 179
soundtrack 255
soup 153, 158
soup bowl 65
soup spoon 65
sour 127
sour cream 137
sourdough bread 139
south 312
South Africa 317
South Korea 318
South Sudan 317
Southern Hemisphere 283
Southern Ocean 313
souvenirs 260
sow *v* 90, 183
soybeans 131
space 280
space exploration 281
space heater 60
space shuttle 281
space station 281
space suit 281
spade 88, 265, 273
Spain 316
spare tire 203
spark plug 203
sparkling 144
sparring 237
sparrow 292
spatula 68, 167
speaker 174, 176, 258, 268
speaker stand 268
spearfishing 245
specials 152
spectators 233
speed limit 195
speed skating 247
speedboat 241
speedometer 201, 204
spell *v* 162
sperm 20
sphere 164
spices 132
spicy sausage 142
spider 295
spike *v* 90
spikes 233
spin 230
spin *v* 76
spin-dryer 76
spinach 123
spine 17
spire 300
spleen 18
splint 47
splinter 46
split ends 39
split peas 131
spoke 207
sponge 73, 74, 83
sponge cake 140
spool 245
spoon 65
sport fishing 245
sports 105, 220, 236, 248
sports car 198
sports field 168
sportcoat 33
sportsman 191
spotlight 259
sprain 46
spray 109
spray *v* 91
spray can 311
spray bottle 89
spring 71, 307
spring balance 166
spring greens 123
springboard 235, 238
sprinkler 89
sprinter 234
sprocket 207
spy hole 59
square 164, 165, 272, 299
square foot 310
square meter 310
squash 231
squat 251
squid 121, 295
squirrel 290
Sri Lanka 318
St. Kitts and Nevis 314
St. Lucia 314
St. Vincent and the Grenadines 314
stable 185, 243
stadium 223
staff 175, 256
stage 167, 254
stages 23
stainless steel 79
stair gate 75
staircase 59
stake 90
stake *v* 91
stalk 122, 297
stalls 254
stamen 297
stamp 98
stamp collecting 273
stamps 112
stance 232
stand 88, 205, 268
stapler 173
staples 173
star 280
star anise 133
starfish 295
starfruit 128
start school *v* 26
starter 153
starting block 234, 238
starting line 234
state 315
statement 180
stationery 105
steak 121
steam *v* 67
steam train 208
steamed 159
steepchase 243
steel wool 81
steering wheel 201
stem 111, 112, 297
stencil 83
stenographer 181
step machine 250
stepdaughter 23
stepfather 23
stepladder 82
stepmother 23
stepson 23
stereo 269
stereo system 268
sterile 47
stern 240
stethoscope 45
stew 158
stick 224, 249
sticks 133
still 144
sting 46, 295
stir *v* 67
stir-fry 158
stirrer 150
stirrup 242
stitch 277
stitch selector 276
stitches 52
stock broker 97
stock exchange 97
stocking 35
stocks 97, 110
stomach 18
stomachache 44
stone 36, 275
stone fruit 126
stop 269
stop button 197
stopper 166
stopwatch 234
store directory 104
stork 292
storm 287
stout 145
straight 39, 165
straight ahead 260
straighten *v* 39
straighteners 38
strap 35
strapless 34
stratosphere 286
straw 144, 154
strawberry 127
strawberry milkshake 149
stream 285
streaming 269
street 298
street corner 298
street sign 298
streetlight 298
stress 55
stretch 251
stretcher 94
strike 228, 237
string 230, 258
string of pearls 36
string bean 122
strings 256
strip *v* 82
stroke 44, 233, 239
strokes 231
stroller 75
strong 321
stub 96
study 63, 162
stuffed 159
stuffed olive 143
stump 225
styles 39, 239, 301
submarine 215
subsoil 91
substitute 223
substitution 223
subtract *v* 165
suburb 299
subway map 209
subway train 209
succulent 87
suction hose 77
Sudan 317
sugarcane 184
suit 273
sulfur 289
summer 31, 307
summons 180
sumo wrestling 237
Sun 280
sun hat 30, 265
sunbathe *v* 264
sunbed 41
sunblock 108, 265
sunburn 46
Sunday 306
sunflower 184, 297
sunflower oil 134
sunflower seed 131
sunglasses 51, 265
sunny 286
sunrise 305
sunroof 202
sunscreen 108
sunset 305
sunshine 286
suntan lotion 265
supermarket 106
supersonic jet 211
supplement 55
supply pipe 61
support 187
suppository 109
surf 241
surfboard 241
surfcasting 245
surfer 241
surfing 241
surgeon 48
surgery 45, 48
Suriname 315
surprised 25

suspect 94, 181
 suspension 203, 205
 swallow 292
 swamp 285
 swan 293
 Swaziland 317
 sweater 33
 sweatshirt 33
 Sweden 316
 sweep *v* 77
 sweet 124, 127, 155
 sweet potato 125
 sweet spreads 134
 sweetcorn 124
 swim *v* 238
 swimmer 238
 swimming 238
 swimming pool 101,
 238, 250
 swimsuit 238, 265
 swing *v* 232
 swings 263
 swiss chard 123
 switch 60
 Switzerland 316
 swivel chair 172
 sword 236
 swordfish 120, 294
 symphony 256
 synagogue 300
 synchronized swimming
 239
 synthetic 31
 Syria 318
 syringe 109, 167
 syrup 109
 system 176

T
 tab 173
 table 64, 148
 table tennis 231
 tablecloth 64
 tachometer 201
 tack *v* 241, 277
 tackle 245
 tackle *v* 220, 223
 tackle box 244
 tadpole 294
 tae kwon do 236
 tag *v* 229
 tai chi 236
 tail 121, 210, 242, 280,
 290, 294
 tailbone 17
 tailgate 198
 taillight 204
 tailor 191
 tailored 35
 tailor's 115
 tailor's chalk 276
 tailor's dummy 276
 tailplane 210
 Taiwan 319

Tajikistan 318
 take a bath *v* 72
 take a shower *v* 72
 take notes *v* 163
 take off *v* 211
 talcum powder 73
 tall 321
 tambourine 257
 tampon 108
 tan 41
 tandem 206
 tangerine 126
 tank 61
 Tanzania 317
 tap 61, 66
 tap water 144
 tape deck 268
 tape dispenser 173
 tape measure 80, 276
 target 249
 target shooting 249
 taro root 124
 tarragon 133
 Tasmania 319
 tattoo 41
 tax 96
 taxi stand 213
 tea 144, 149, 184
 tea bag 144
 tea with lemon 149
 tea with milk 149
 teacher 162, 191
 teacup 65
 team 220, 229
 teapot 65
 tear 51
 teaspoon 65
 teat 75
 techniques 79, 159
 teddy bear 75
 tee 233
 teeing ground 232
 teenager 23
 tee off *v* 233
 telegram 98
 telephone 99
 telephone booth 99
 teleprompter 179
 telescope 281
 television 268
 television series 178
 television studio 178
 temperature 286
 temperature gauge 201
 temple 14, 300
 ten 308
 ten thousand 309
 tenant 58
 tend *v* 91
 tendon 17
 tennis 230
 tennis court 230
 tennis shoes 231
 tenon saw 81

tent 267
 tent peg 266
 tent pole 266
 tenth 309
 tequila 145
 terminal 212
 termite 295
 terrace café 148
 territory 315
 test 49, 163
 test tube 166
 testicle 21
 text (SMS) 99
 text message 99
 textbook 163
 Thailand 318
 thank you 322
 Thanksgiving 27
 theater 254, 299
 theme park 262
 therapist 55
 thermal underwear 35
 thermals 267
 thermometer 45, 167
 thermosphere 286
 thermostat 61
 thesis 169
 thick 321
 thigh 12, 119
 thimble 276
 thin 321
 third 309
 third floor 104
 thirteen 308
 thirteenth 309
 thirtieth 309
 thirty 308
 this way up 98
 this week 307
 thistle 297
 thoracic vertebrae 17
 thread 276
 thread *v* 277
 thread guide 276
 thread reel 276
 three 308
 three hundred 308
 hatchback 200
 three-point line 226
 thriller 255
 throat 19
 throttle 204
 through 320
 throw 237
 throw *v* 221, 227, 229
 throw-in 223, 226
 thruster 281
 thumb 15
 thumbtack 173
 thunder 286
 Thursday 306
 thyme 133
 thyroid gland 18
 tibia 17

ticket 209, 213
 ticket gate 209
 ticket inspector 209
 ticket office 209, 216
 tie 32
 tiebreaker 230
 tie-pin 36
 tiger 291
 tights 35, 251
 tile 58, 272
 tile *v* 82
 till 106, 150
 tiller 240
 timber 187
 time 234, 304
 time out 220
 timer 166
 times 165, 261
 timing 203
 tip 36, 122, 246
 tissue 108
 title 168
 titles 23
 to 320
 to go 154
 toad 294
 toast 157
 toasted sandwich 149
 toaster 66
 tobacco 112, 184
 today 306
 toddler 30
 toe 15
 toe clip 207
 toe strap 207
 toenail 15
 toffee 113
 toggle 31
 Togo 317
 toilet 61, 72
 toilet brush 72
 toilet paper 72
 toilet seat 72
 toiletries 41, 107
 toilets 104, 266
 toll booth 194
 tomato 125, 157
 tomato juice 144, 149
 tomorrow 306
 ton 310
 toner 41
 tongs 150, 167
 tongue 19, 37, 118
 tonic water 144
 tool rack 78
 toolbar 177
 toolbelt 186
 toolbox 80
 tools 187
 tooth 50
 toothache 50
 toothbrush 72
 toothpaste 72
 top coat 83

top-dress *v* 90
 top tier 141
 topaz 288
 topiary 87
 topping 155
 topsoil 85
 tornado 287
 tortoise 293
 tossed salad 158
 touch line 221
 touchdown 221
 tour bus 197, 260
 tour guide 260
 tourer 205
 touring bike 206
 tourist 260
 tourist attraction 260
 tourist information 261
 tourmaline 288
 tournament 233
 tow away *v* 195
 tow truck 203
 toward 320
 towel bar 72
 towels 73
 tower 300
 town 298
 town hall 299
 townhouse 58
 toy 75
 toy basket 75
 toys 105
 track 208, 234
 track and field 234
 tractor 182
 traffic 194
 traffic jam 195
 traffic light 194
 traffic police 195
 trailer 266
 train 35, 208
 train *v* 91, 251
 train station 208
 trainer 37
 training wheels 207
 tram 196, 208
 transfer 223
 transformer 60
 transmission 202
 transplant *v* 91
 transportation 194
 trapezium 164
 trapezius 16
 trash 177
 travel agent 190, 114
 travel brochure 212
 travel sickness pills 109
 traveler's check 97
 tray 152, 154
 tray-table 210
 tread 207
 tread water *v* 239
 treadmill 250
 treble clef 256

triangle 164, 257
triceps 16
trifle 141
trim *v* 39, 90
trimester 52
trimmer 88
Trinidad and Tobago 314
tripod 166, 270, 281
trolley bus 196
trombone 257
tropic of Cancer 283
tropic of Capricorn 283
tropical fruit 128
tropics 283
troposphere 286
trot 243
trough 183
trout 120
trowel 89, 187
truck 194
truck driver 190
truffle 113, 125
trumpet 257
trunk 198, 291, 296
trunks 238
try 221
T-shirt 30, 33
tub 311
tuba 257
tube 311
Tuesday 306
tugboat 215
tulip 111
tumble 235
tumble-dryer 76
tumbler 65
tuna 120
tune *v* 179
tune the radio *v* 269
tuning peg 258
Tunisia 317
turbocharger 203
turf *v* 90
Turkey 316
turkey 119, 185, 293
Turkmenistan 318
turmeric 132
turn 238
turn *v* 79
turn off the television *v* 269
turn on the television *v* 269
turn signal 198, 204
turnip 124
turpentine 83
turquoise 289
turret 300
turtle 293
tusk 291
tutu 191
tweezers 40, 47, 167
twelfth 309
twelve 308

twentieth 309
twenty 308
twenty minutes 304
twenty thousand 309
twenty-first 309
twenty-one 308
twenty-second 309
twenty-third 309
twenty-two 308
twig 296
twin bed 71
twin room 100
twine 89
twins 23
twist ties 89
two 308
two hundred 308
two o'clock 304
two thousand 307
two thousand and one 307
two-door 200
types 199, 205
types of buses 196
types of cameras 270
types of farms 183
types of plants 86
types of fishing 245
types of trains 208
tire 198, 205, 206
tire iron 207
tire pressure 203

U
Uganda 317
ugli fruit 126
Ukraine 316
ulna 17
ultralight 211
ultrasound 52
ultraviolet rays 286
umbilical cord 52
umbrella 36, 233
umbrella stand 59
umpire 225, 229, 230
uncle 22
unconscious 47
uncooked meat 142
under 320
under par 233
undercoat 83
underexposed 271
undergraduate 169
underpass 194
underwear 32, 35
underwired 35
uniform 94, 189
United Arab Emirates 318
United Kingdom 316
United States of America 314
universe 280
university 299

unleaded 199
unpasteurized 137
unpick *v* 277
unsalted 137
until 320
up 320
upset 25
Uranus 280
ureter 21
urethra 20
urinary 19
urology 49
Uruguay 315
usher 255
uterus 20, 52
utility knife 81
utility room 76
Uzbekistan 318

V
vacation 212
vacuum cleaner 77, 188
vacuum cup 53
vacuum flask 267
vagina 20
valance 71
valley 284
valve 207
vanilla 132
Vanuatu 319
varnish 79, 83
vas deferens 21
vase 63, 111
Vatican City 316
vault 235, 300
veal 118
vegetable garden 85, 182
vegetable oil 135
vegetable peeler 68
vegetables 107, 122, 124
veggie burger 155
veil 35
vein 19
venetian blind 63
Venezuela 315
venison 118
vent 283
Venus 280
verdict 181
vest 33, 35, 251
veterinarian 189
vibraphone 257
video game 269
video phone 99
video tape 269
Vietnam 318
viewfinder 271
village 299
vine 183
vinegar 135, 142
vineyard 183
vintage 199

viola 256
violin 256
virus 44
visa 213
vise 78
vision 51
visiting hours 48
visor 205
vitamins 108
V-neck 33
vocal cords 19
vodka 145
voice message 99
volcano 283
volley 231
volleyball 227
voltage 60
volume 165, 179, 269, 311
vomit *v* 44

W
waders 244
wading pool 263
waffles 157
waist 12
waistband 35
waistcoat 33
waiter 148, 152
waiting room 45
waitress 191
wake up *v* 71
walk 243
walking boot 37, 267
walkway 212
wall 58, 186, 222
wall light 62
wallet 37
wallpaper 82, 177
wallpaper *v* 82
wallpaper brush 82
wallpaper paste 82
walnut 129
walnut oil 134
walrus 290
ward 48
wardrobe 70
warehouse 216
warm 286
warm up *v* 251
warrant 180
wash *v* 38, 77
washer 80
washer fluid 199
washer fluid reservoir 202
washing machine 76
wasp 295
waste disposal 61, 266
waste disposal unit 61
waste pipe 61
wastebasket 172
watch 36
watch television *v* 269

water 144, 238
water *v* 90, 183
water bottle 206, 267
water chamber 61
water chestnut 124
water garden 84
water hazard 232
water heater 61
water jet 95
water plant 86
water polo 239
watercolor paints 274
watercross 123
waterfall 285
watering 89
watering can 89
watermelon 127
waterskier 241
waterskiing 241
watersports 241
wave 241, 264
wavelength 179
wax 41
weak 321
weather 286
weaving 277
website 177
wedding 26, 35
wedding cake 141
wedding dress 35
wedding reception 26
wedge 37, 233
Wednesday 306
weed *v* 91
weedkiller 91
weeds 86
week 306
weekend 306
weekly 307
weigh *v* 310
weight 166, 244
weight bar 251
weight belt 239
weight training 251
wellington boots 31
west 312
western 255
Western Sahara 317
wet 286, 321
wet wipe 75, 108
wetsuit 239
whale 290
wheat 130, 184
wheel 198, 207
wheel nuts 203
wheelbarrow 88
wheelchair 48
wheelchair access 197
whetstone 81
whiplash 46
whipped cream 137
whisk 68
whisk *v* 67
whiskers 290

- whiskey 145
 white 39, 145, 272, 274
 white bread 139
 white chocolate 113
 white coffee 148
 white currant 127
 white flour 138
 white meat 118
 white rice 130
 whiting 120
 whole 129, 132
 whole milk 136
 whole-grain 131
 whole-grain mustard 135
 whole-wheat bread 139
 whole-wheat flour 138
 wicket 225
 wide 321
 width 165
 wife 22
 Wifi 269
 wig 39
 wild rice 130
 willow 296
 win v 273
 wind 241, 286
 windbreak 265
 windlass 214
 window 58, 96, 98, 177,
 186, 197, 209, 210
 windpipe 18
 windshield 198, 205
 windshield wiper 198
 windsurfer 241
 windsurfing 241
 windy 286
 wine 145, 151
 wine glass 65
 wine list 152
 wine vinegar 135
 wing 119, 210, 293
 wings 254
 winner 273
 winter 31, 307
 winter sports 247
 wipe v 77
 wire 79
 wire cutter 80
 wire strippers 81
 wires 60
 with 320
 withdrawal slip 96
 without 320
 witness 180
 wok 69
 wolf 290
 woman 23
 womb 52
 women's clothing 34,
 105
 wood 79, 233, 275, 285
 wood glue 78
 wood shavings 78
 wood stain 79
 wooden spoon 68
 woodpecker 292
 woodwind 257
 woodworking 275
 wool 277
 work 172
 work day 306
 workbench 78
 workshop 78
 world map 312
 worm 295
 worried 25
 wound 46
 wrap 155
 wrapping 111
 wreath 111
 wrench 80, 81, 203
 wrestling 236
 wrinkle 15
 wrist 13, 15
 wristband 230
 writ 180
 write v 162
X
 X-ray 48
 X-ray film 50
 X-ray machine 212
 X-ray viewer 45
Y
 yacht 215, 240
 yam 125
 yard 310
 yawn v 25
 year 163, 306
 yeast 138
 yellow 274
 yellow card 223
 Yemen 318
 yes 322
 yesterday 306
 yoga 54
 yogurt 137
 yolk 137, 157
 you're welcome 322
 Yugoslavia 316
Z
 Zambia 317
 zebra 291
 zero 308
 zest 126
 Zimbabwe 317
 zinc 289
 zip 277
 ZIP code 98
 zone 315
 zones 283
 zoo 262
 zoology 169
 zoom lens 270
 zucchini 125

agradecimientos • acknowledgments

DORLING KINDERSLEY would like to thank Tracey Miles and Christine Lacey for design assistance, Georgina Garner for editorial and administrative help, Sonia Gavira, Polly Boyd, and Cathy Meeus for editorial help, and Claire Bowers for compiling the DK picture credits.

The publisher would like to thank the following for their kind permission to reproduce their photographs:

Abbreviations key: a-above; b-below/bottom; c-center; f-far; l-left; r-right; t-top)

I23RF.com: Andriy Popov 34tl; Daniel Ernst 179cr; Hongqi Zhang 24cla. 175cr; Ingvar Bjork 60c; Kobby Dagan 259c; leonardo255 269c; Liubov Vadimovna (Luba) Nel 39cla; Ljupco Smokovski 75crb; Oleksandr Marynchenko 60bl; Olga Popova 33c; oneblink 49bc; Racorn 162tl; Robert Churchill 94c; Roman Gorielov 33bc; Ruslan Kudrin 35bc, 35br; Subbotina 39cra; Sutichak Yachaingkhram 39tc; Tarzhanova 37c; Vitaly Valua 39tl; Wavebreak Media Ltd 188bl; Wilawan Khasawong 75cb;
Action Plus: 224bc; **Alamy Images:** 154t; A.T. Willett 287bcl; Alex Segre 105ca, 105cb, 195cd; Ambrophoto 24cra; Blend Images 168cr; Cultura RM 33r; Doug Houghton 107fbr; Ekkapon Sriharun 172bl; Hugh Threlfall 35tl; 176tr; Ian Allenden 48br; Ian Dagnall (iPod is a trademark of Apple Inc., registered in the U.S. and other countries) 268tc, 270t; Ievgen Chepil 250bc; imagebroker 199tl, 249c; Keith Morris 178c; Martyn Evans 210b; MBI 175tl; Michael Burrell 213cra; Michael Foyle 184bl; Oleksiy Maksymenko 105tc; Paul Weston 168br; Prisma Bildagentur AG 246b; Radharc Images 197tr; RBtravel 112tl; Ruslan Kudrin 176tl; Sasa Huzjak 258t; Sergey Kravchenko 37ca; Sergio Azenha 270bc; Stanca Sanda (iPad is a trademark of Apple Inc., registered in the U.S. and other countries) 176bc; Stock Connection 287bcr; tarczas 35cr; vityalysuprn 176cl; Wavebreak Media Ltd 39cl, 174b, 175tr; **Allsport/Getty Images:** 238cl; **Alvey and Towers:** 209acr, 215bcl, 215bcr, 241cr; **Peter Anderson:** 188cbr, 271br.
Anthony Blake Photo Library: Charlie Stebbings 114cl; John Sims 114tcl; **Andyalt:** 98tl; **apple mac computers:** 268tr; **Arcaid:** John Edward Linden 301bl; Martine Hamilton Knight, Architects: Chapman Taylor Partners, 213cl; Richard Bryant 301br; **Argos:** 41tcl, 66cbl, 66cl, 66br, 66bcl, 69cl, 70bcl, 71t, 77tl, 269tc, 270tl; **Axiom:** Eitan Simanon 105bcr; Ian Cumming 104; Vicki Couchman 148cr; **Beken Of Cowes Ltd:** 215cb; **Bosch:** 76ctr, 76tc, 76tcl; **Camera Press:** 38tr, 256t, 257cr; Barry J. Holmes 148tr; Jane Hanger 159cr; Mary Germanou 259bc; **Corbis:** 78b; Anna Clopet 247tr; Ariel Skelley / Blend Images 52l; Bettmann 181tl, 181tr; Blue Jean Images 48bl; Bo Zauders 156t; Bob Rowan 152bl; Bob Winsett 247cbl; Brian Bailey 247br; Carl and Ann Purcell 162l; Chris Rainer 247ct; Craig Aurness 215bl; David H.Wells 249cbr; Dennis Marsico

274bl; Dimitri Lundt 236bc; Duomo 211tl; Gail Mooney 277ctr; George Lepp 248c; Gerald Nowak 239b; Gunter Marx 248cr; Jack Hollingsworth 231bl; Jacqui Hurst 277cbr; James L. Amos 247bl, 191ctr, 220bcr; Jan Butchofsky 277cb; Johnathan Blair 243cr; Jose F. Poblete 191br; Jose Luis Pelaez.Inc 153tc; Karl Weatherly 220bl, 247tr; Kelly Mooney Photography 259tl; Kevin Fleming 249bc; Kevin R. Morris 105tr, 243tl, 243tc; Kim Sayer 249tr; Lynn Goldsmith 258t; Macduff Everton 231bcl; Mark Gibson 249bl; Mark L. Stephenson 249ct; Michael Pole 115tr; Michael S. Yamashita 247ctcl; Mike King 247cbl; Neil Rabinowitz 214br; Pablo Corral 115bc; Paul A. Sounders 169br, 249ctcl; Paul J. Sutton 224c, 224br; Phil Schermeister 227b, 248tr; R. W Jones 309; Richard Morrell 189bc; Rick Doyle 241ctr; Robert Holmes 97br, 277ct; Roger Ressmeyer 169tr; Russ Schleipman 229; The Purcell Team 211ctr; Vince Streato 194t; Wally McNamee 220br, 220bcl, 224bl; Wavebreak Media LTD 191bc; Yann Arhus-Bertrand 249tl; **Demetrio Carrasco / Dorling Kindersley (c) Herge / Les Editions Casterman:** 112ccl; **Dorling Kindersley:** Banbury Museum 35c; Five Napkin Burger 152t; **Dixons:** 270cl, 270cr, 270bl, 270bcl, 270bcr, 270ccr; **Dreamstime.com:** Alexander Podshivalov 179tr, 191cr; Alexxl66 268tl; Andersastphoto 176tc; Andrey Popov 191bl; Arne9001 190tl; Chaos 26c; Designstock 269cl; Monkey Business Images 26clb; Paul Michael Hughes 162tr; Serghei Starus 190bc; **Education Photos:** John Walmsley 26tl; **Empics Ltd:** Adam Day 236br; Andy Heading 243c; Steve White 249cbr; **Getty Images:** 48bcl, 100t, 114bcr, 154bl, 287tr; 94tr; Don Farrall / Digital Vision 176c; Ethan Miller 270bl; Inti St Clair 179bl; Liam Norris 188br; Sean Justice / Digital Vision 24br; **Dennis Gilbert:** 106tc; **Hulsta:** 70t; **Ideal Standard Ltd:** 72r; **The Image Bank/Getty Images:** 58; **Impact Photos:** Eliza Armstrong 115cr; Philip Achache 246t; **The Interior Archive:** Henry Wilson, Alfie's Market 114bl; Luke White, Architect: David Mikhail, 59tl; Simon Upton, Architect: Philippe Starck, St Martins Lane Hotel 100bcr, 100br; **iStockphoto.com:** asterix0597 163tl; EdStock 190br; RichLegg 26bc; SorinVidis 27cr; **Jason Hawkes Aerial Photography:** 216t; **Dan Johnson:** 35r; **Kos Pictures Source:** 215cbl, 240tc, 240tr; David Williams 216b; **Lebrecht Collection:** Kate Mount 169bc; **MP Visual.com:** Mark Swallow 202t; **NASA:** 280cr, 280ccl, 281tl; **P&O Princess Cruises:** 214bl; **P A Photos:** 181br; **The Photographers' Library:** 186bl, 186bc, 186t; **Plain and Simple Kitchens:** 66t; **Powerstock Photolibrary:** 169tl, 256t, 287tc; **PunchStock:** Image Source 195tr; **Rail Images:** 208c, 208cbl, 209br; **Red Consultancy:** Odeon cinemas 257br; **Redferns:** 259br; Nigel Crane 259c; **Redx**

Features: 106br, 259tc, 259tr, 259bl, 280b; Charles Ommaney 114ctr; J.F.F Whitehead 243cl; Patrick Barth 101tl; Patrick Frilet 189cbl; Scott Wiseman 287bl; **Royalty Free Images:** Getty Images/Eyewire 154bl; **Science & Society Picture Library:** Science Museum 202b; **Science Photo Library:** IBM Research 190cla; NASA 281cr; **SuperStock:** Ingram Publishing 62; Juanma Aparicio / age fotostock 172t; Nordic Photos 269tl; **Skyscan:** 168t, 182c, 298; Quick UK Ltd 212; **Sony:** 268bc; **Robert Streeter:** 154br; **Neil Sutherland:** 82tr, 83tl, 90t, 118, 188ctr, 196t, 196tr, 299cl, 299bl; **The Travel Library:** Stuart Black 264t; **Travelex:** 97cl; **Vauxhall:** Technik 198t, 199tl, 199tr, 199cl, 199cr, 199ctcl, 199ctcr, 199ctcl, 199tr, 200; **View Pictures:** Dennis Gilbert, Architects: ACDP Consulting, 106t; Dennis Gilbert, Chris Wilkinson Architects, 209tr; Peter Cook, Architects: Nicholas Crimshaw and partners, 208t; **Betty Walton:** 185br; **Colin Walton:** 2, 4, 7, 9, 10, 28, 42, 56, 92, 95c, 99tl, 99tcl, 102, 116, 120t, 138t, 146, 150t, 160, 170, 191ctcl, 192, 218, 252, 260br, 260l, 261tr, 261c, 261cr, 271cbl, 271cbr, 271ctcl, 278, 287br, 302, 401.

DK PICTURE LIBRARY:

Akhil Bahkshi; Patrick Baldwin; Geoff Brightling; British Museum; John Bulmer; Andrew Butler; Joe Cornish; Brian Cosgrove; Andy Crawford and Kit Houghton; Philip Dowell; Alistair Duncan; Gables; Bob Gathany; Norman Hollands; Kew Gardens; Peter James Kindersley; Vladimir Koziik; Sam Lloyd; London Northern Bus Company Ltd; Tracy Morgan; David Murray and Jules Selmes; Musée Vivant du Cheval, France; Museum of Broadcast Communications; Museum of Natural History; NASA; National History Museum; Norfolk Rural Life Museum; Stephen Oliver; RNLi; Royal Ballet School; Guy Ryecart; Science Museum; Neil Setchfield; Ross Simms and the Winchcombe Folk Police Museum; Singapore Symphony Orchestra; Smart Museum of Art; Tony Souter; Erik Svensson and Jeppe Wikstrom; Sam Tree of Keygrove Marketing Ltd; Barrie Watts; Alan Williams; Jerry Young.

Additional Photography by Colin Walton.

Colin Walton would like to thank:

A&A News, Uckfield; Abbey Music, Tunbridge Wells; Arena Mens Clothing, Tunbridge Wells; Burrells of Tunbridge Wells; Gary at Di Marco's; Jeremy's Home Store, Tunbridge Wells; Noakes of Tunbridge Wells; Ottakar's, Tunbridge Wells; Selby's of Uckfield; Sevenoaks Sound and Vision; Westfield, Royal Victoria Place, Tunbridge Wells.

All other images © Dorling Kindersley
 For further information see: www.dkimages.com